

D

C

B

A

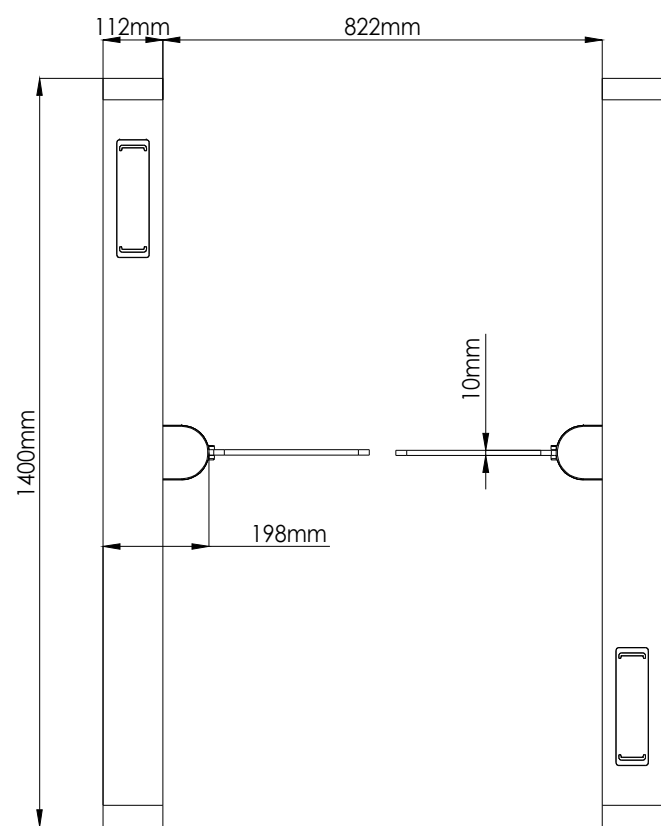
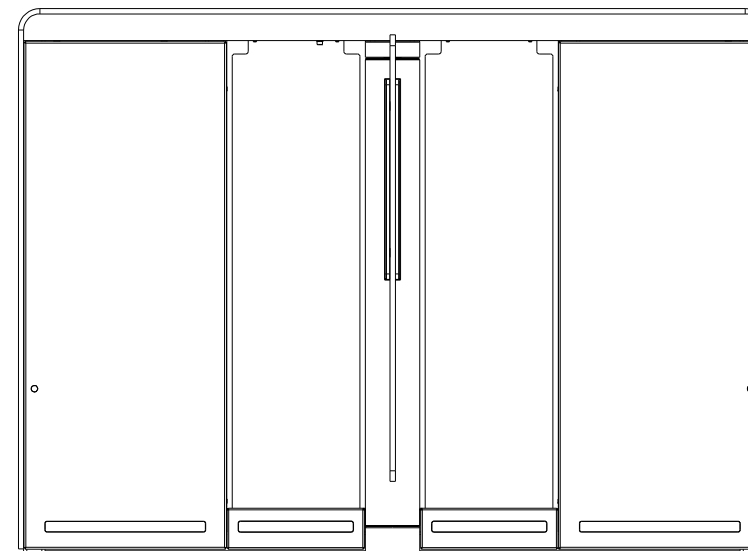
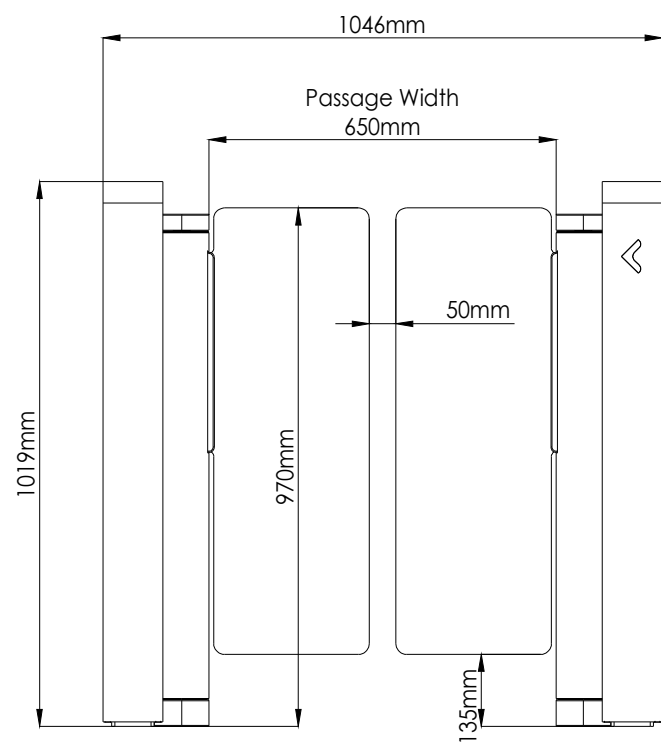

# ASSA ABLOY

DRAWING NAME:  
SG 400 CENTER GLASS 1400 / 650-970

DRAWING NUMBER:  
CD-1179-02

DRAWN	DATE	SIZE	REV
F.C	04.06.2026	A4	Rev-001

D

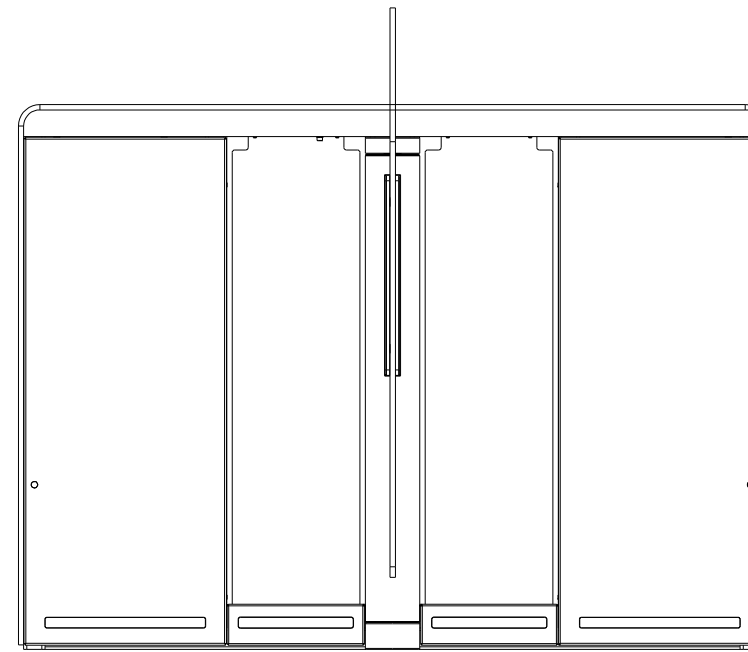
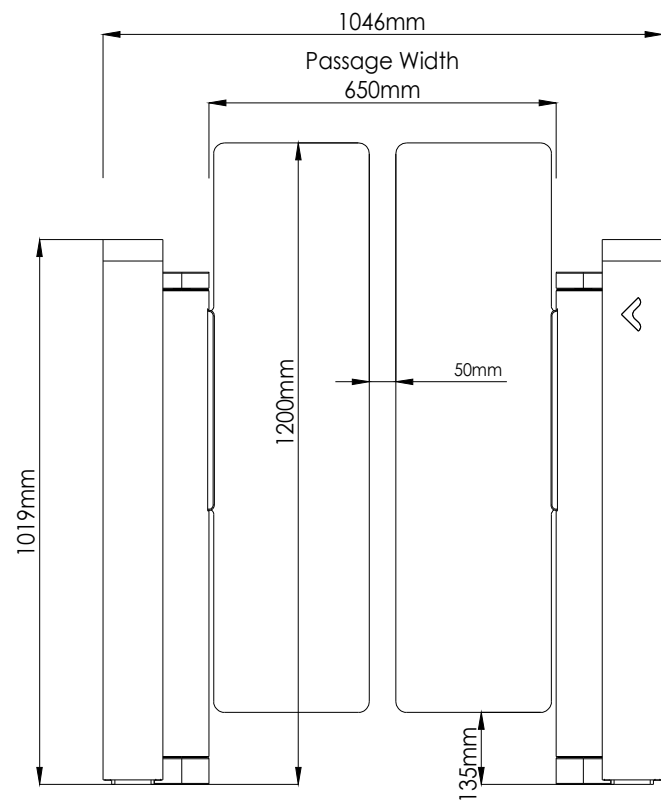

C

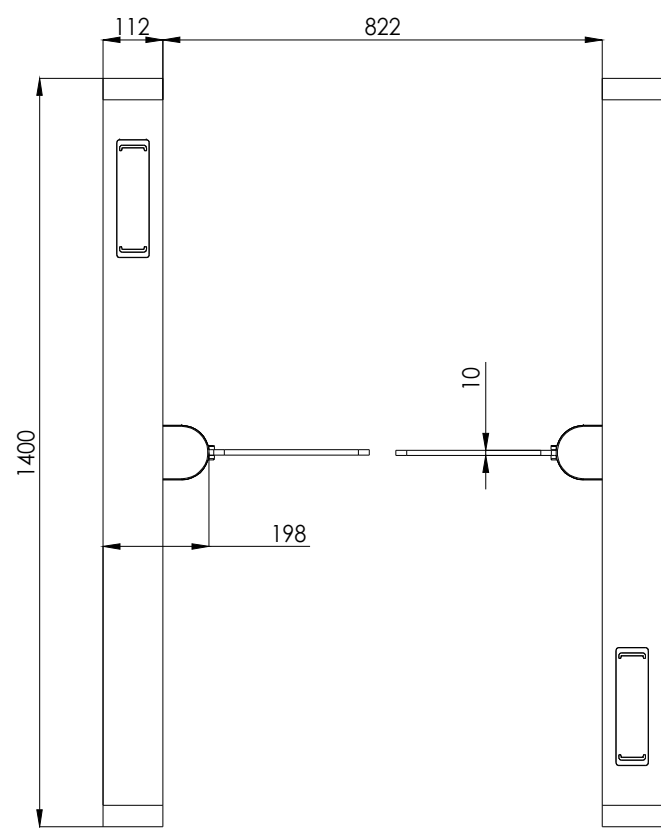

B

A

<b>ASSA ABLOY</b>			
DRAWING NAME: SG 400 CENTER GLASS 1400 / 650-1200			
DRAWING NUMBER: CD-1180-02			
DRAWN F.C	DATE 04.06.2026	SIZE A4	REV Rev-001
SCALE: 1:1		SHEET: 1 OF 1	

D

C

B

A

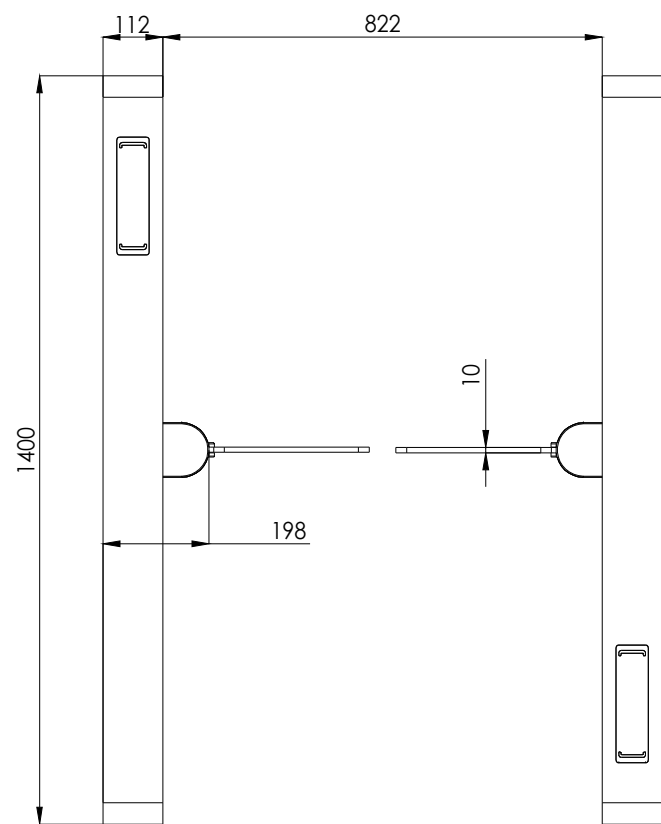
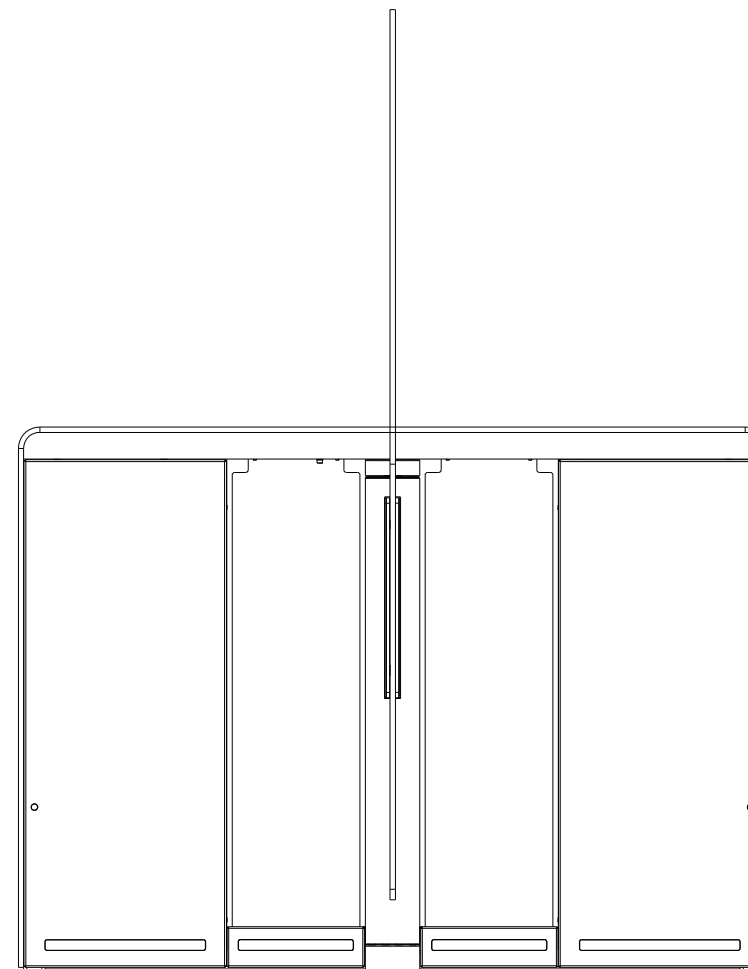
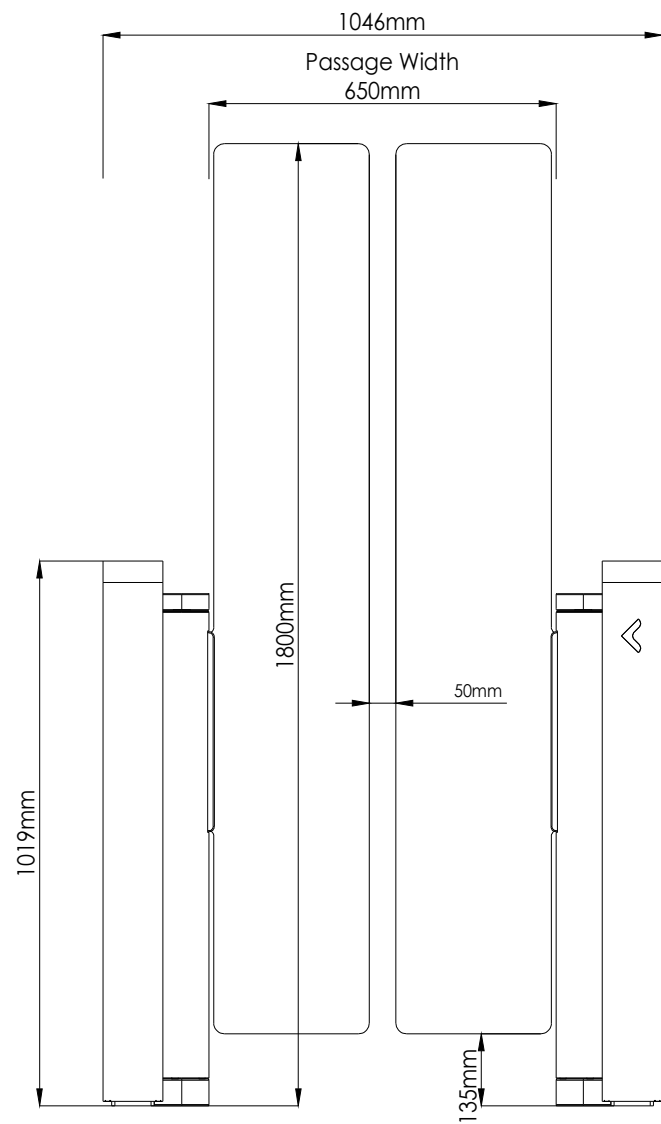

# ASSA ABLOY

DRAWING NAME:  
SG 400 CENTER GLASS 1400 / 650-1800

DRAWING NUMBER:  
CD-1181-02

DRAWN	DATE	SIZE	REV
F.C	04.06.2026	A4	Rev-001

D

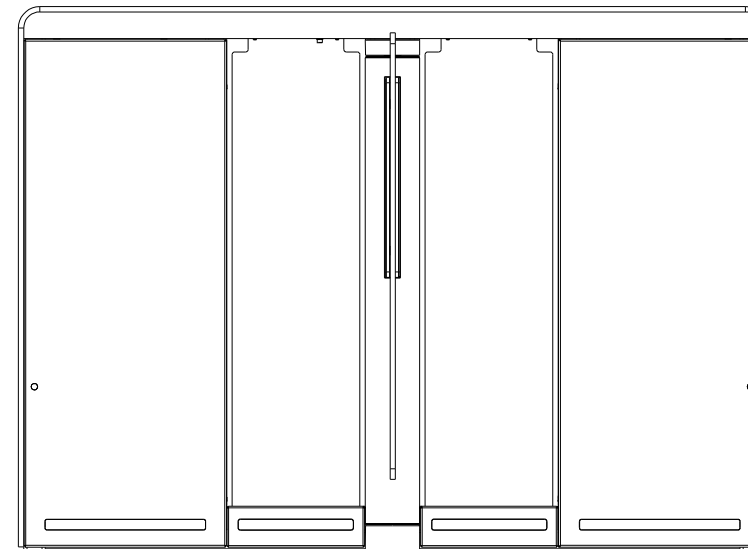
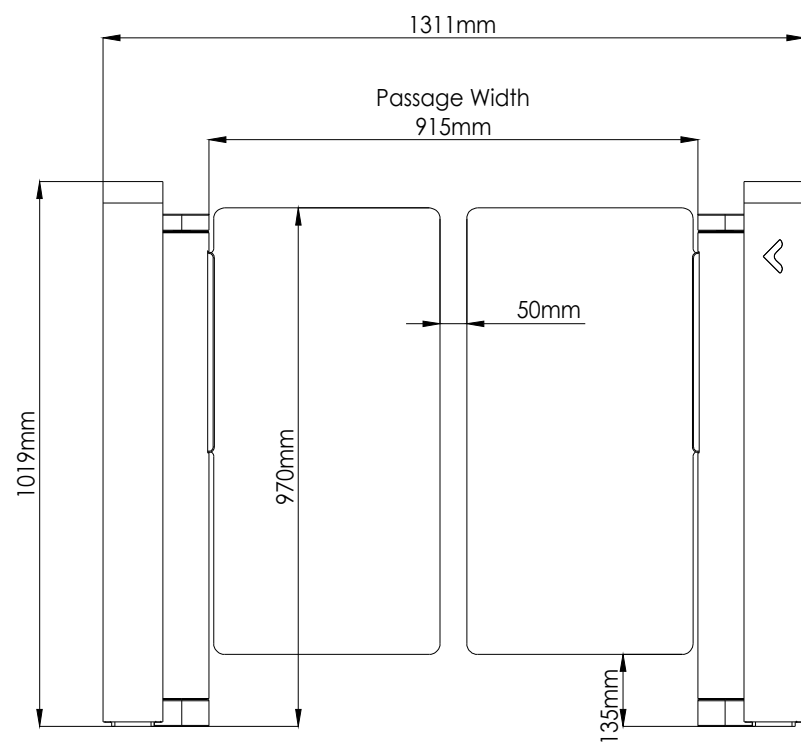

C

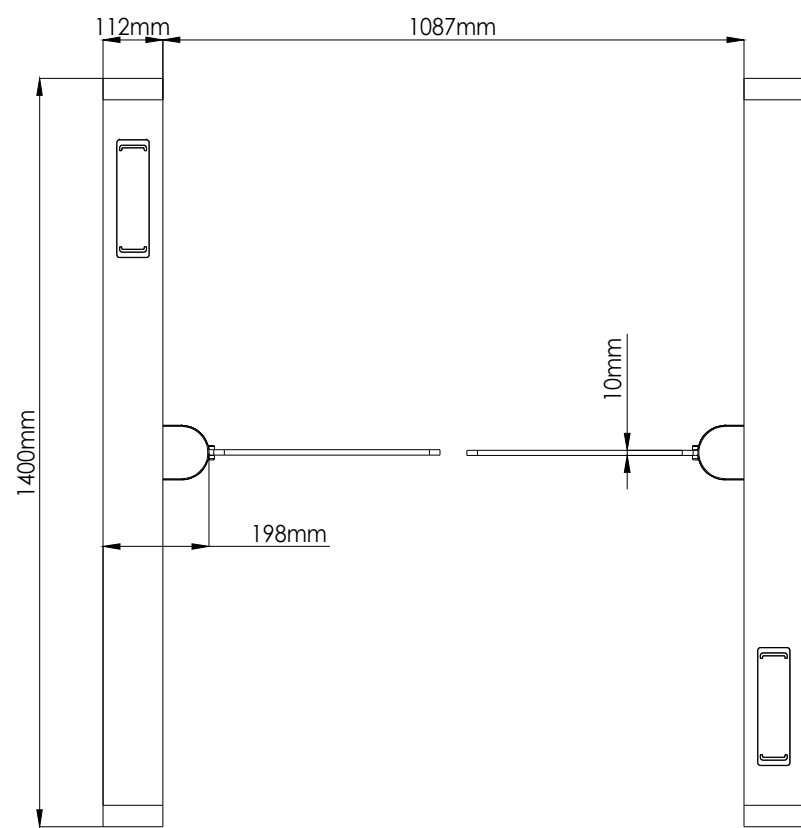

B

A

**ASSA ABLOY**

DRAWING NAME:  
SG 400 CENTER GLASS 1400 / 915-970

DRAWING NUMBER:  
CD-1182-02

DRAWN F.C	DATE 04.06.2026	SIZE A4	REV Rev-001
--------------	--------------------	------------	----------------

SCALE: 1:1 SHEET: 1 OF 1

D

C

B

A

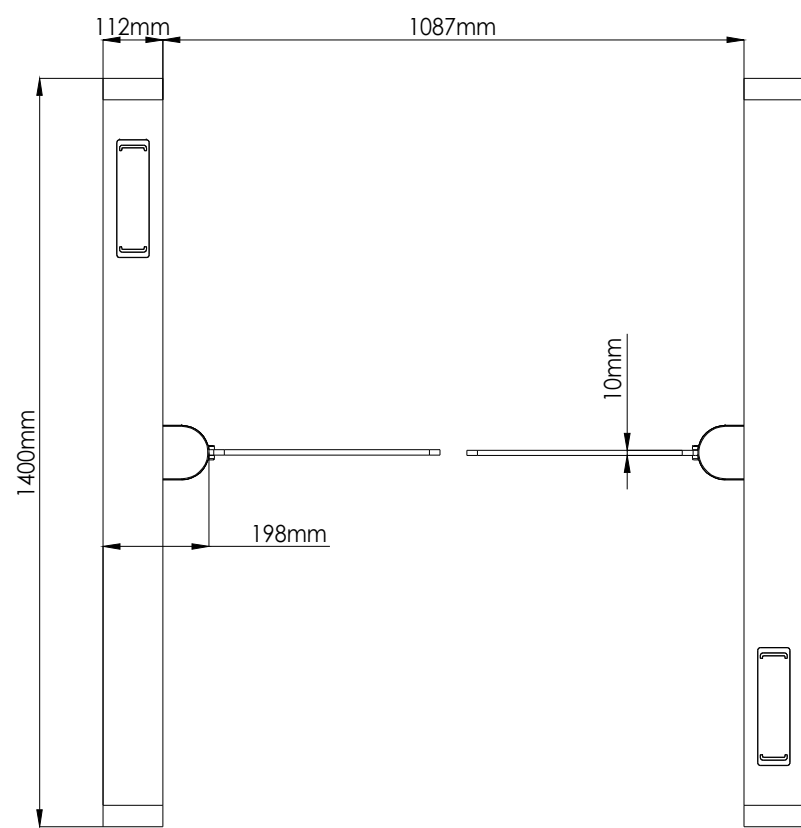
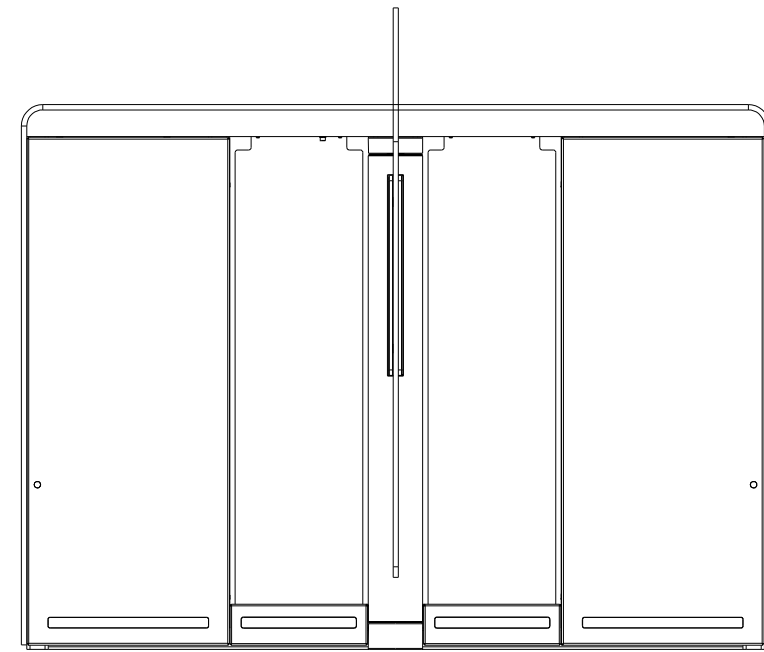
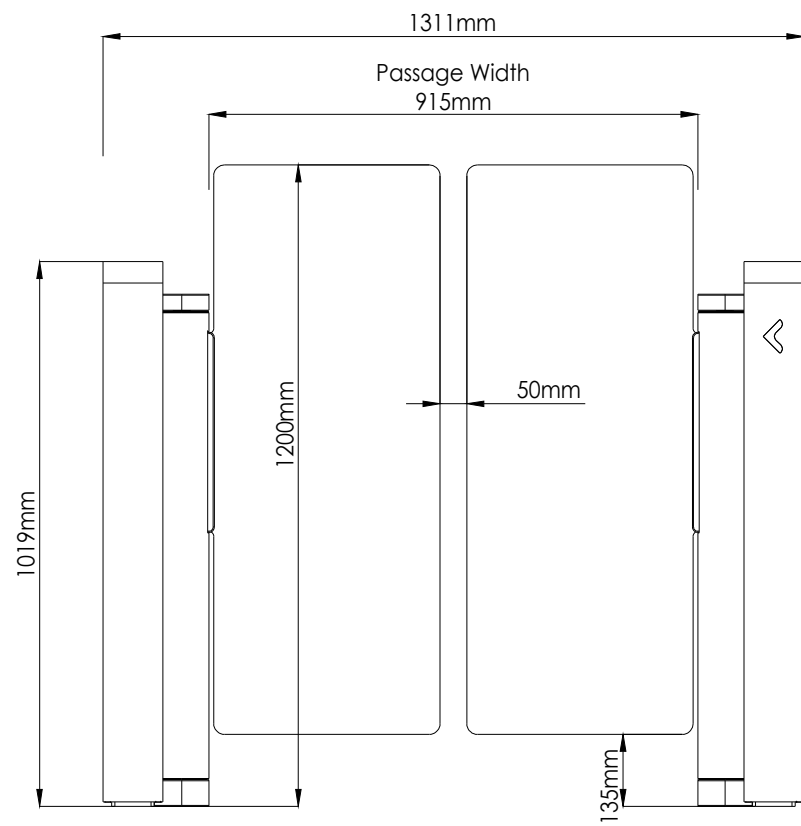

<b>ASSA ABLOY</b>			
DRAWING NAME: SG 400 CENTER GLASS 1400 / 915-1200			
DRAWING NUMBER: CD-1183-02			
DRAWN F.C	DATE 04.06.2026	SIZE A4	REV Rev-001
SCALE: 1:1		SHEET: 1 OF 1	

D

C

B

A

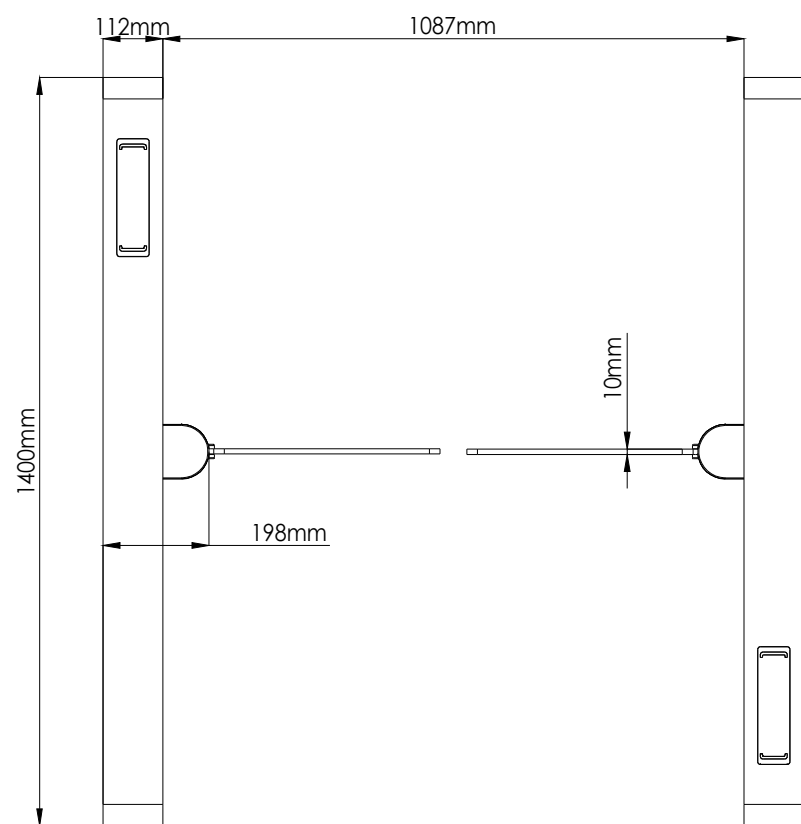
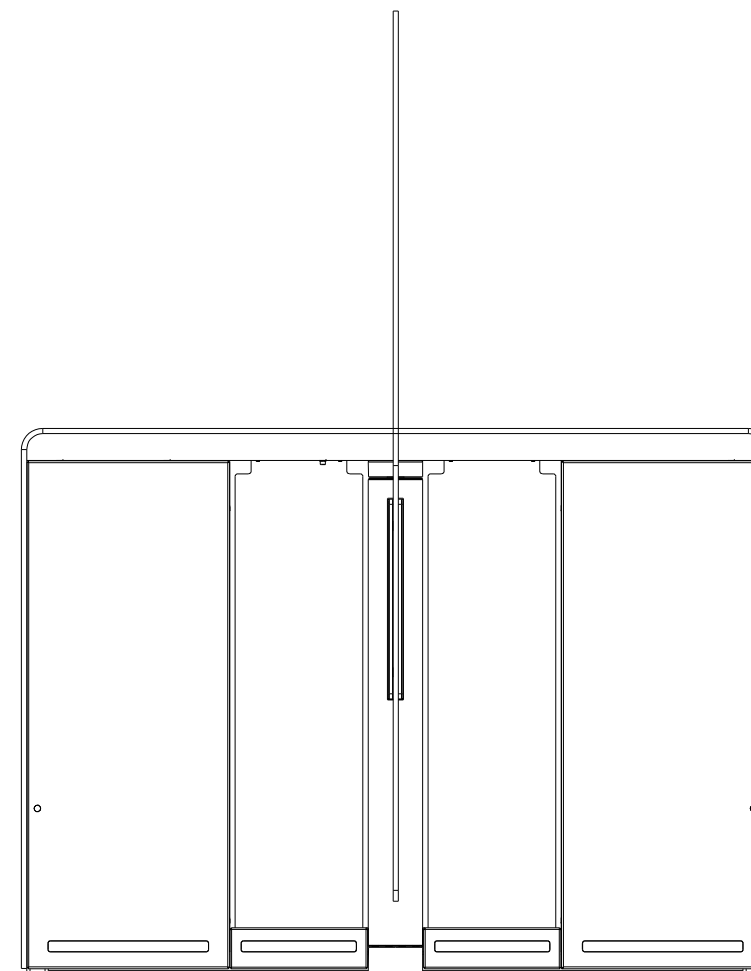
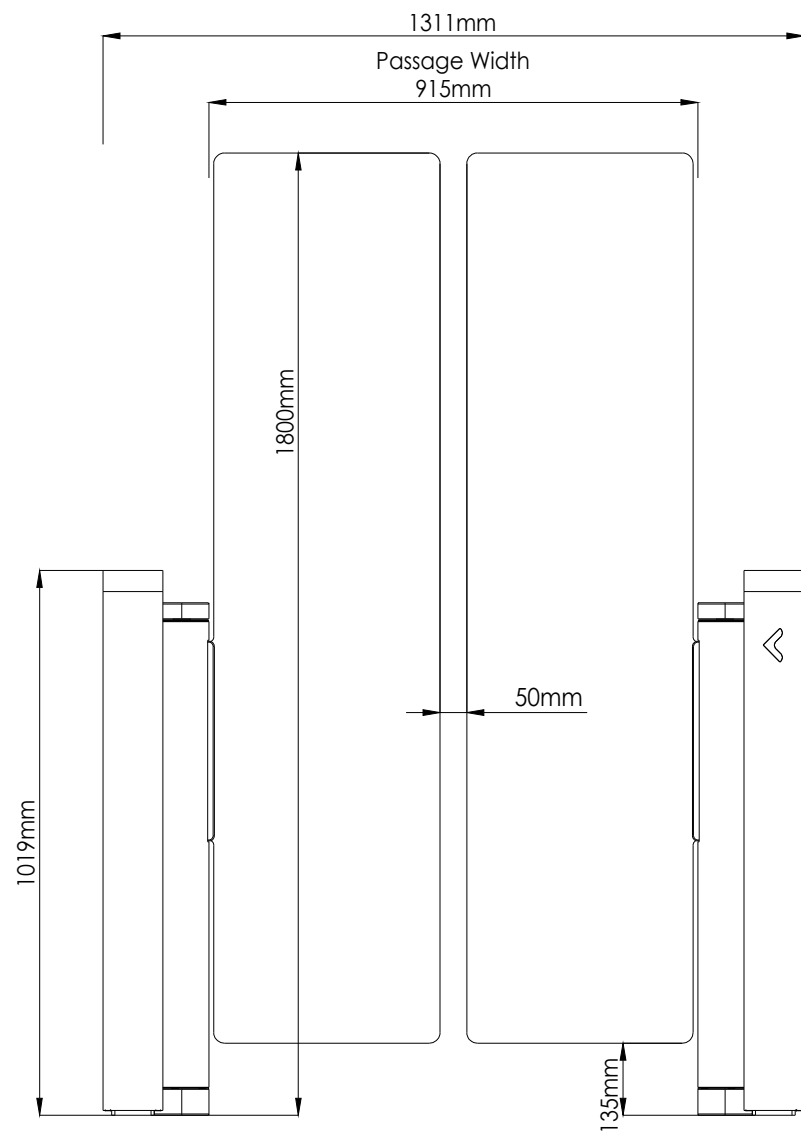

# ASSA ABLOY

DRAWING NAME:  
SG 400 CENTER GLASS 1400 / 915-1800

DRAWING NUMBER:  
CD-1184-02

DRAWN	DATE	SIZE	REV
F.C	04.06.2026	A4	Rev-001

SCALE: 1:1 SHEET: 1 OF 1

D

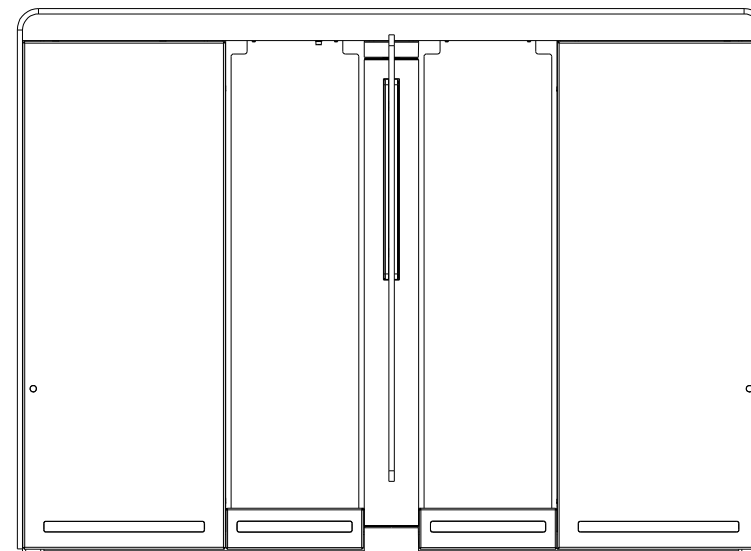
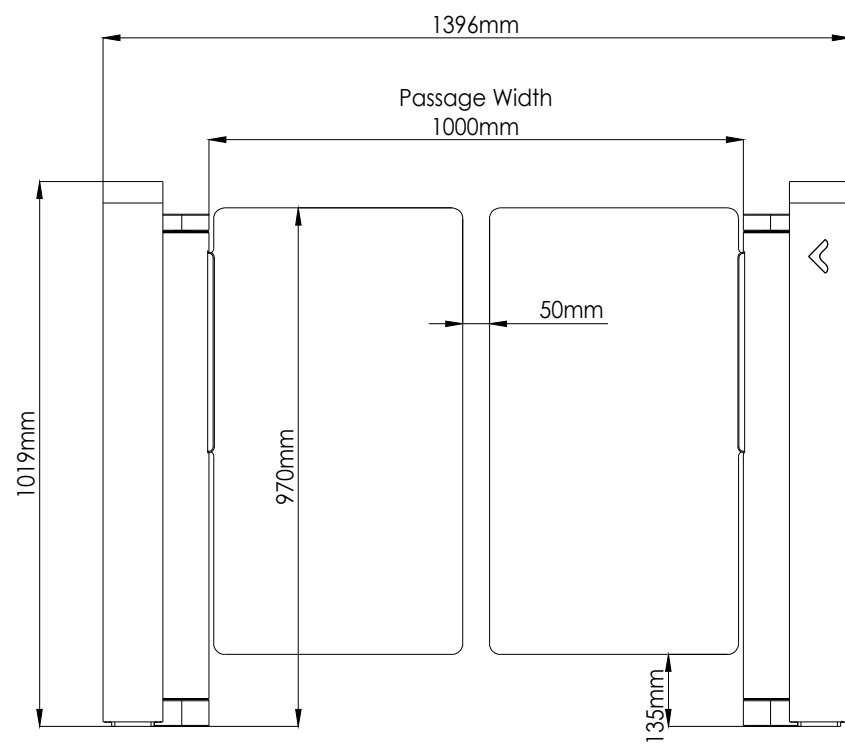

C

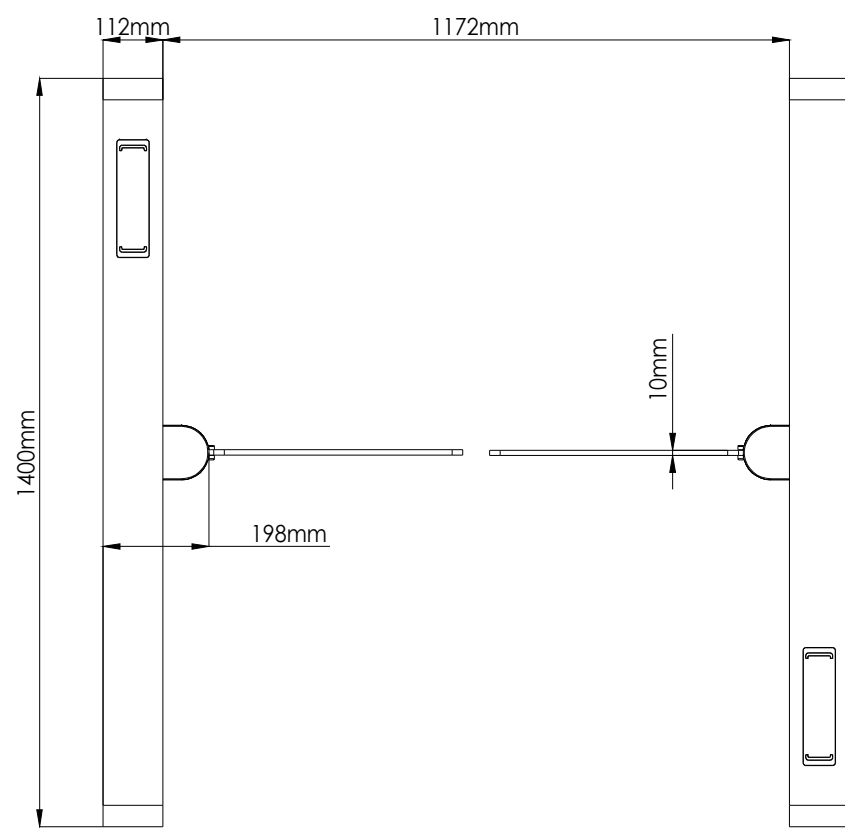

B

A

**ASSA ABLOY**

DRAWING NAME:  
SG 400 CENTER GLASS 1400 / 1000-970

DRAWING NUMBER:  
CD-1185-02

DRAWN	DATE	SIZE	REV
F.C	04.06.2026	A4	Rev-001

SCALE: 1:1 SHEET: 1 OF 1

D

C

B

A

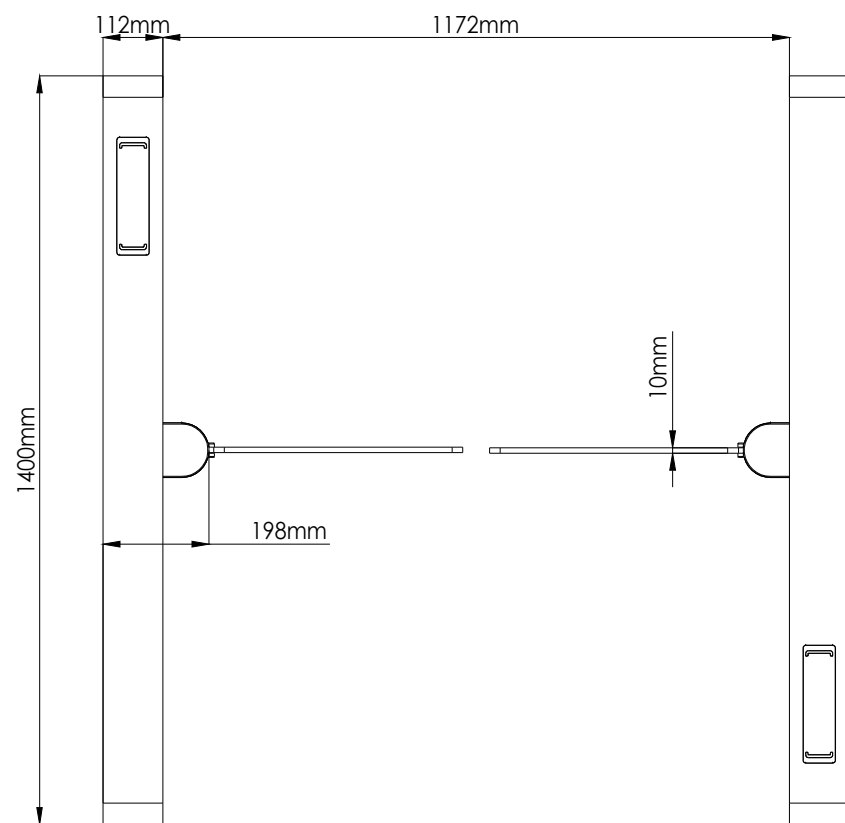
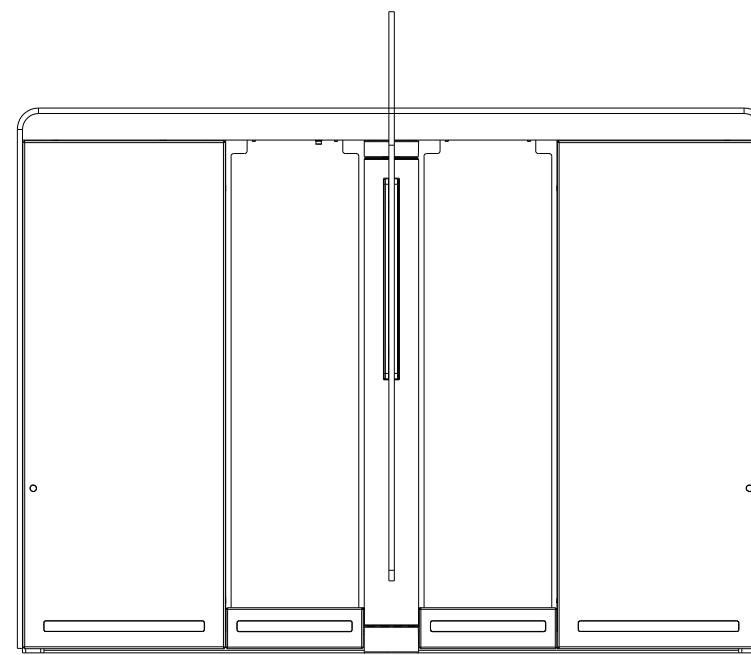
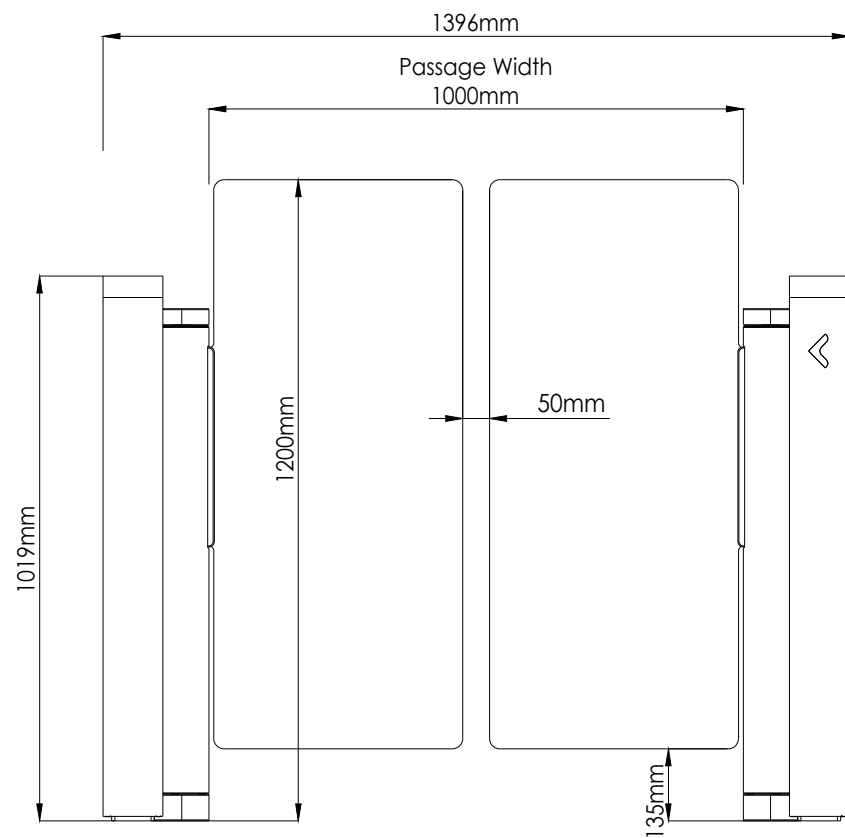

# ASSA ABLOY

DRAWING NAME:  
SG 400 CENTER GLASS 1400 / 1000-1200

DRAWING NUMBER:  
CD-1186-02

DRAWN	DATE	SIZE	REV
F.C	04.06.2026	A4	Rev-001

SCALE: 1:1 SHEET: 1 OF 1

D

C

B

A

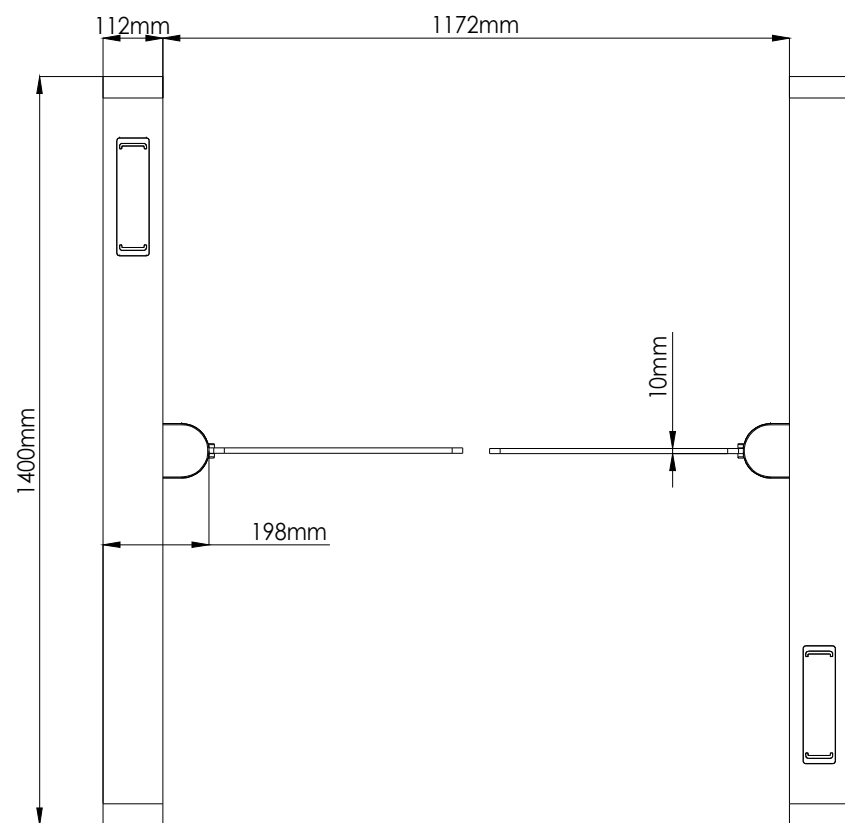
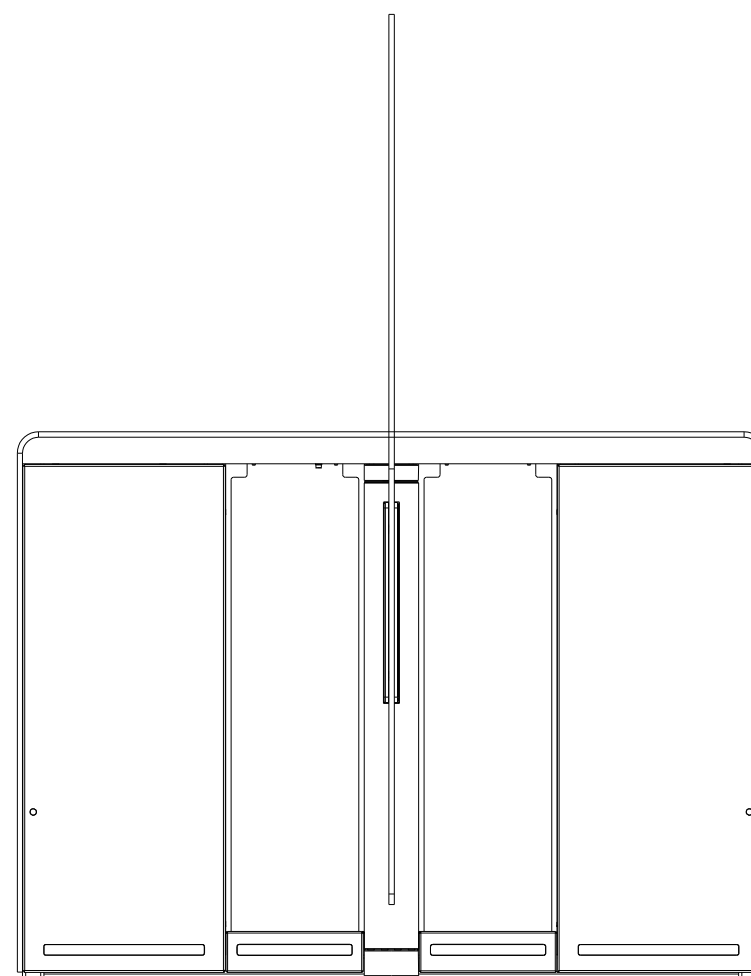
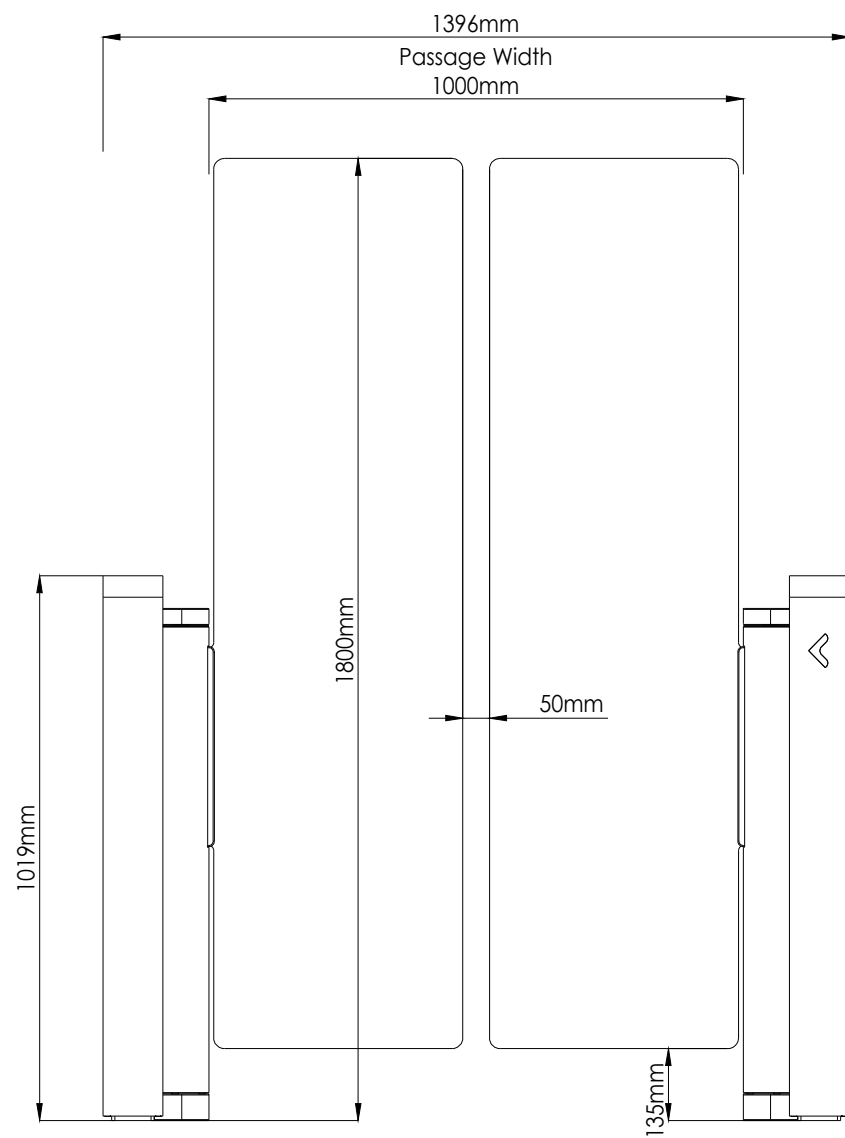

<b>ASSA ABLOY</b>			
DRAWING NAME: SG 400 CENTER GLASS 1400 / 1000-1800			
DRAWING NUMBER: CD-1187-02			
DRAWN F.C	DATE 04.06.2026	SIZE A4	REV Rev-001
SCALE: 1:1		SHEET: 1 OF 1	

D

C

B

A

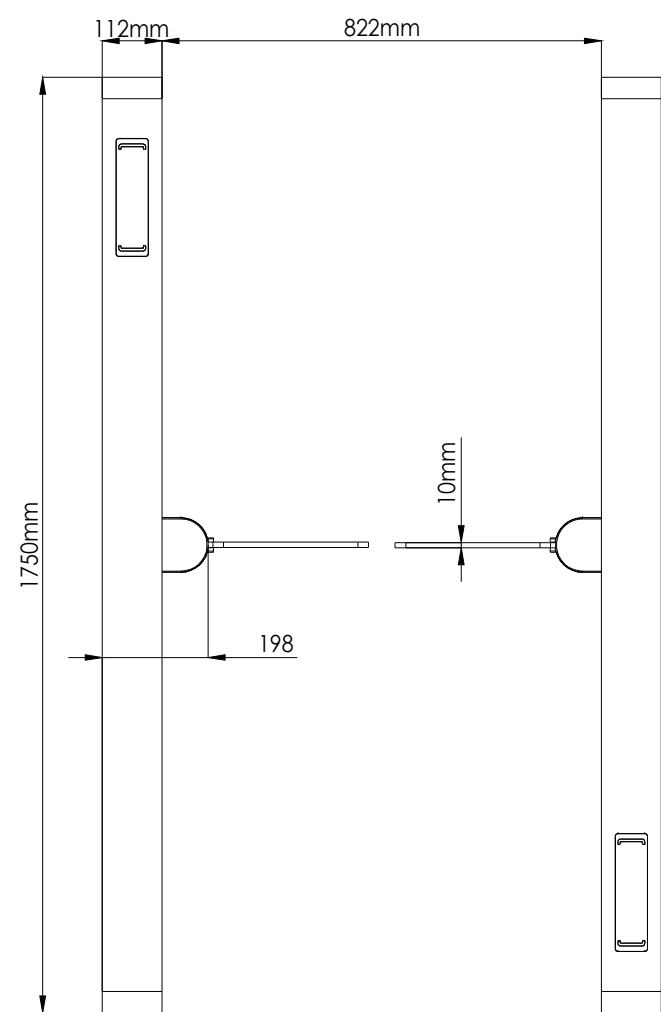
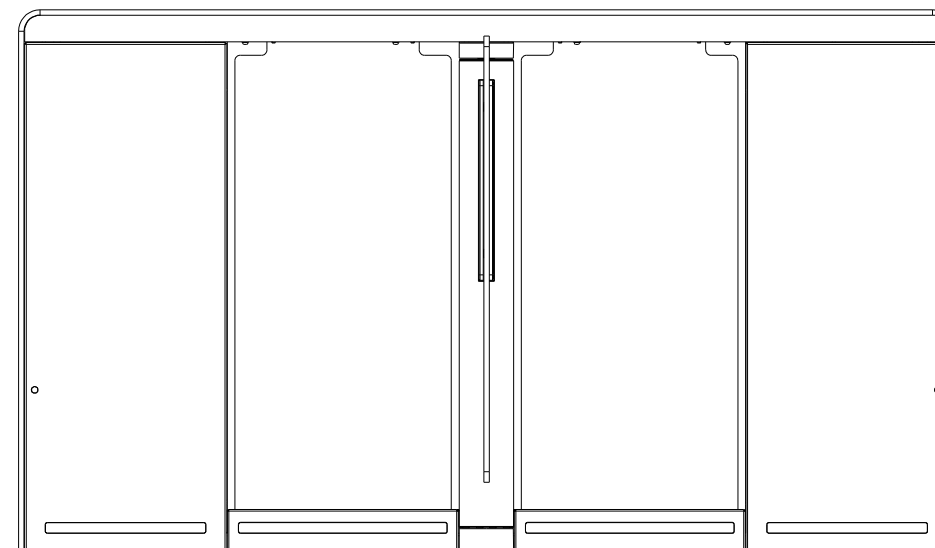
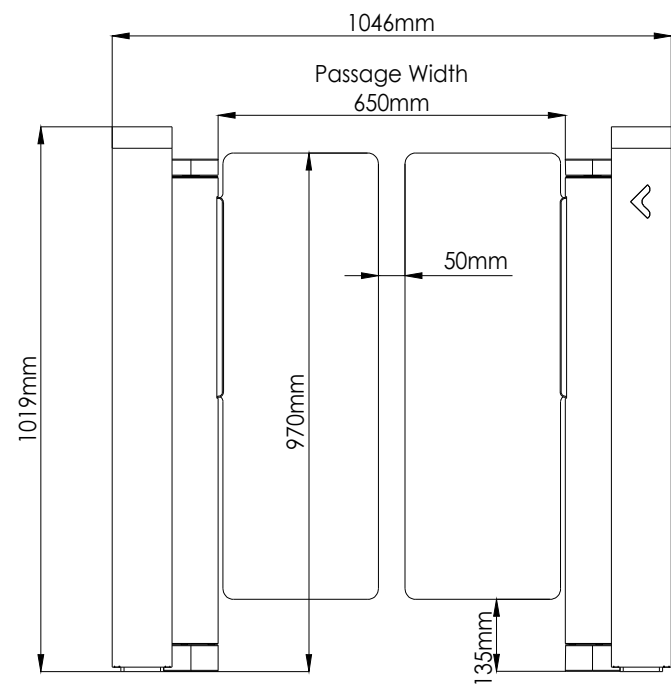

# ASSA ABLOY

DRAWING NAME:  
SG 400 CENTER GLASS 1750 / 650-970

DRAWING NUMBER:  
CD-1188-02

DRAWN	DATE	SIZE	REV
F.C	04.06.2026	A4	Rev-001

D

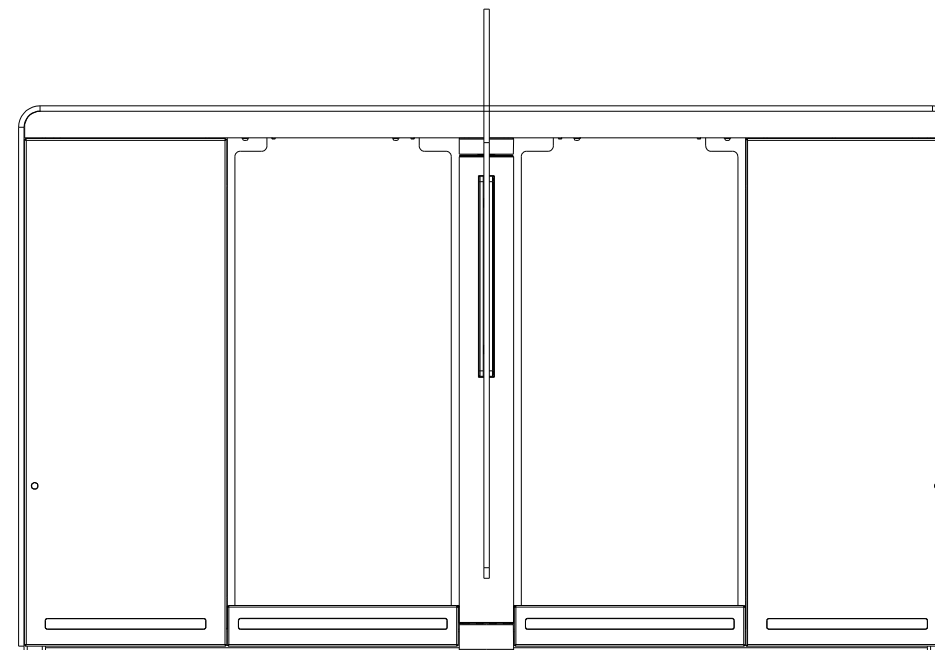
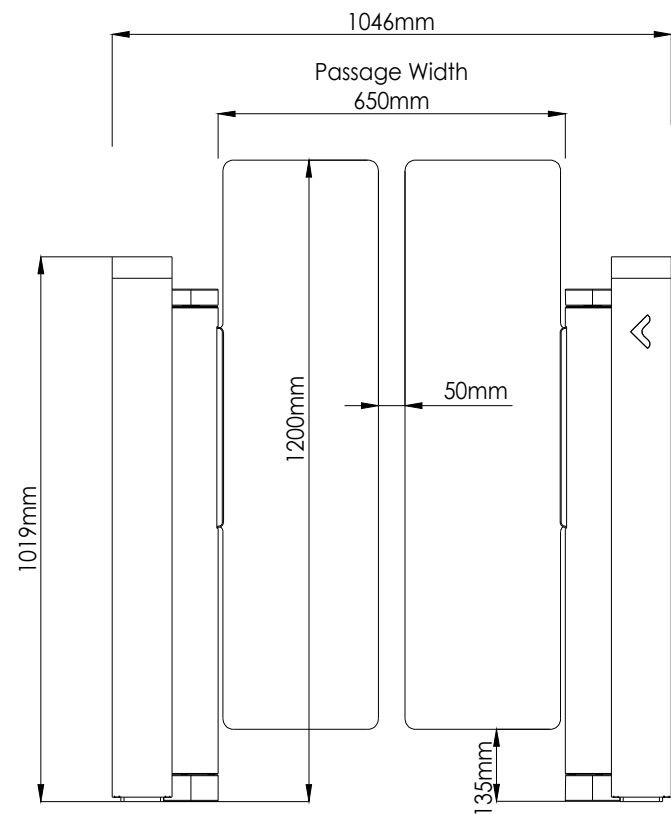

C

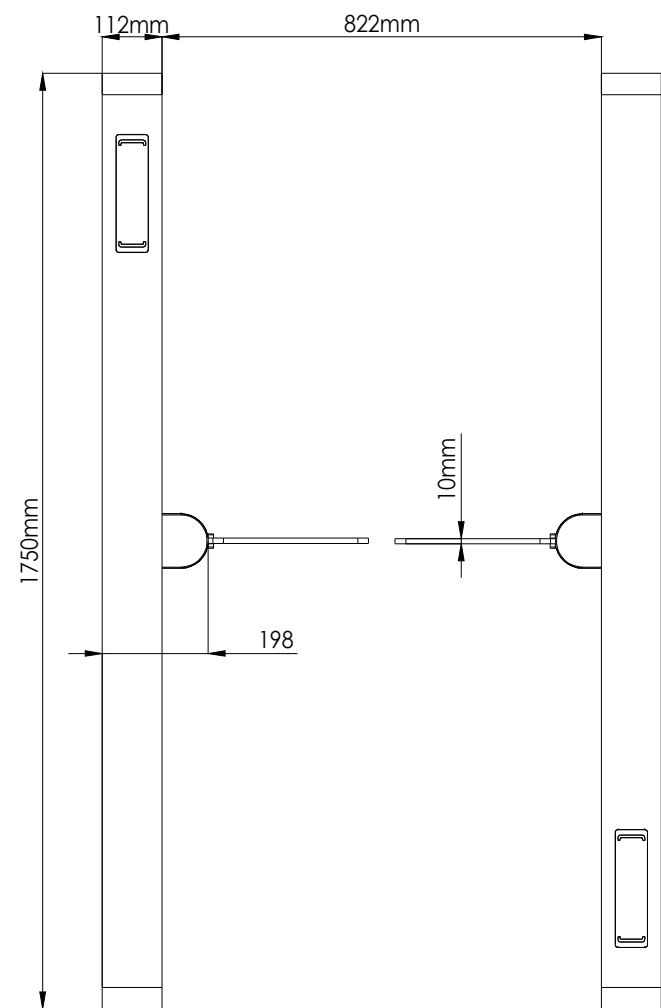

B

A

<b>ASSA ABLOY</b>			
DRAWING NAME: SG 400 CENTER GLASS 1750 / 650-1200			
DRAWING NUMBER: CD-1189-02			
DRAWN F.C	DATE 04.06.2026	SIZE A4	REV Rev-001
SCALE: 1:1		SHEET: 1 OF 1	

4

3

2

1

D

C

B

A

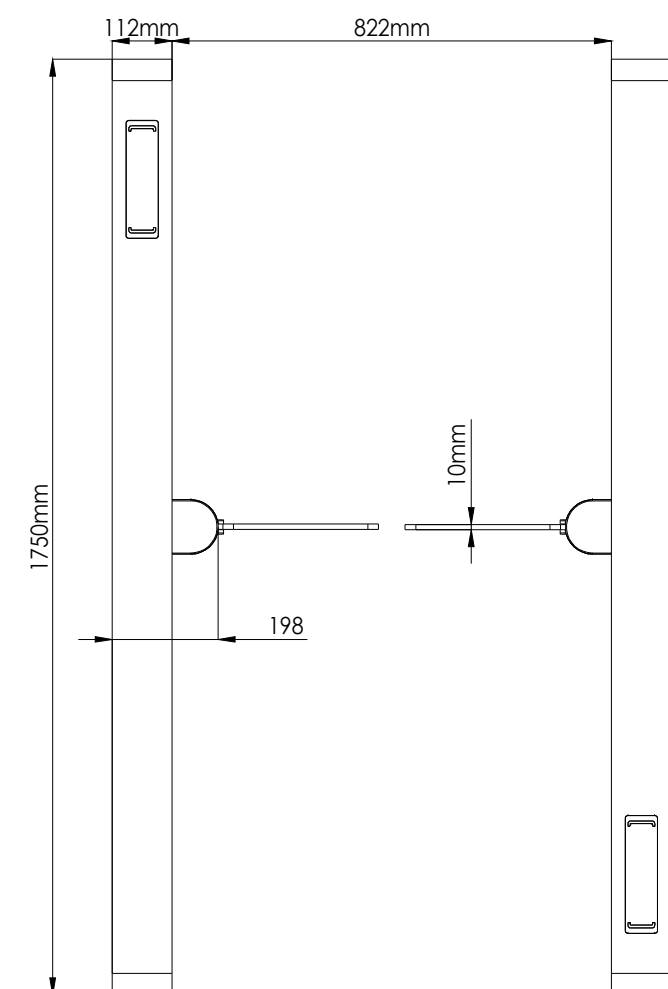
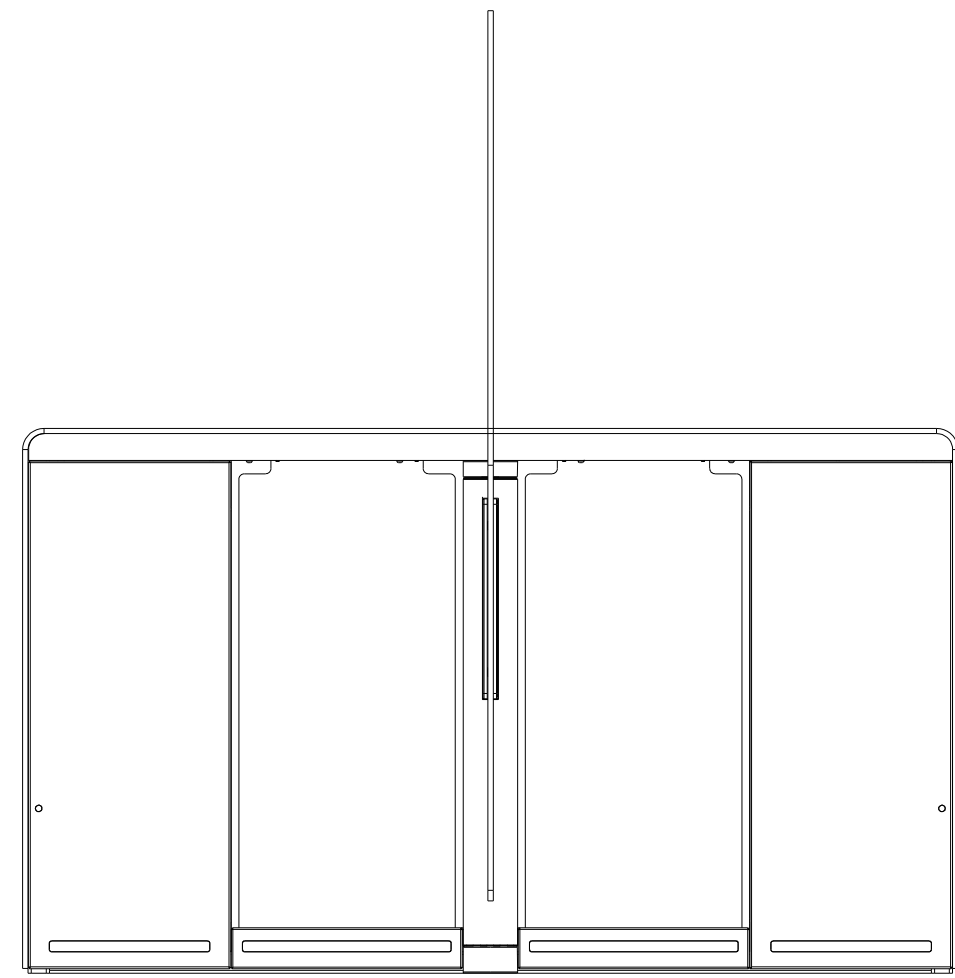
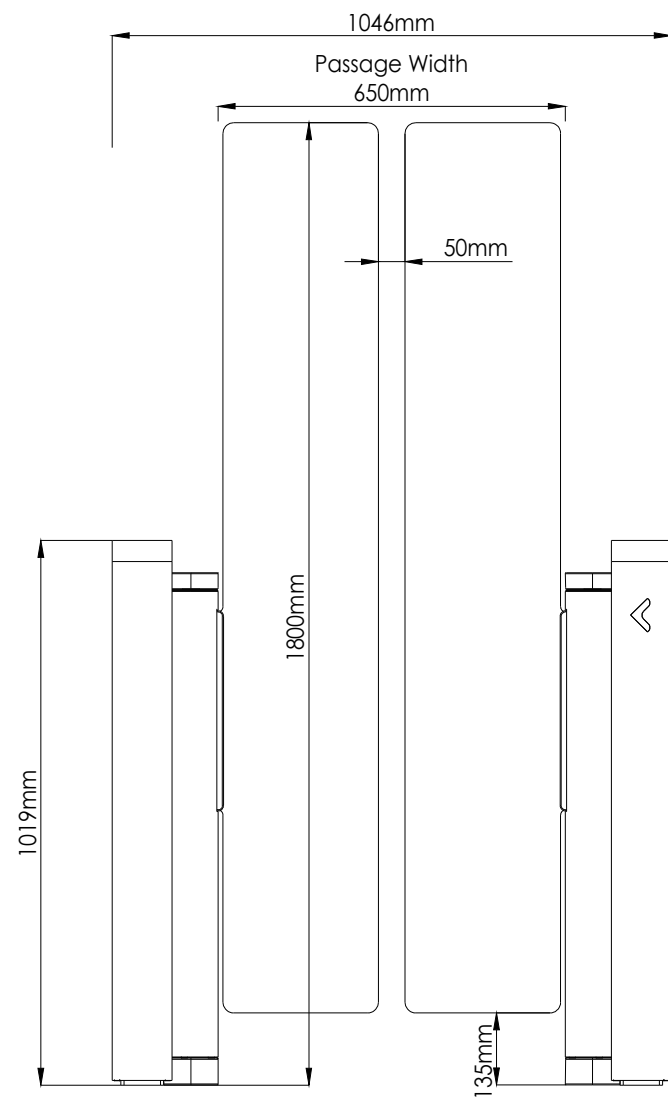

**ASSA ABLOY**

DRAWING NAME:  
SG 400 CENTER GLASS 1750 / 650-1800

DRAWING NUMBER:  
CD-1190-02

DRAWN F.C	DATE 04.06.2026	SIZE A4	REV Rev-001
--------------	--------------------	------------	----------------

SCALE: 1:1 SHEET: 1 OF 1

D

C

B

A

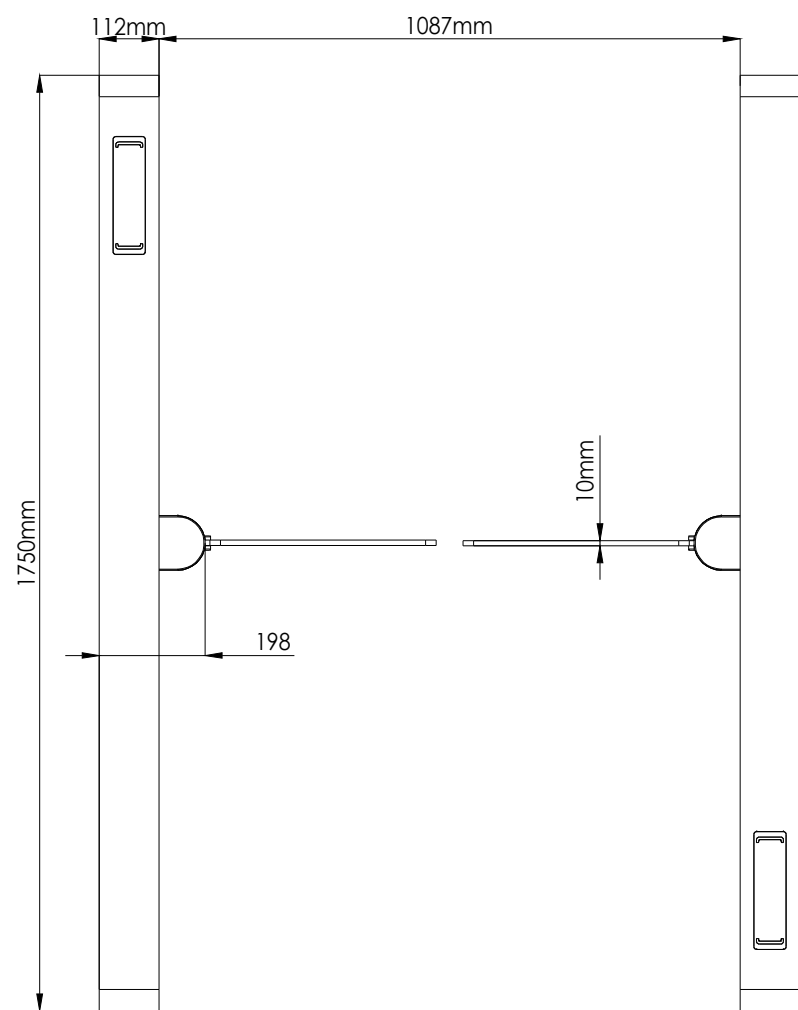
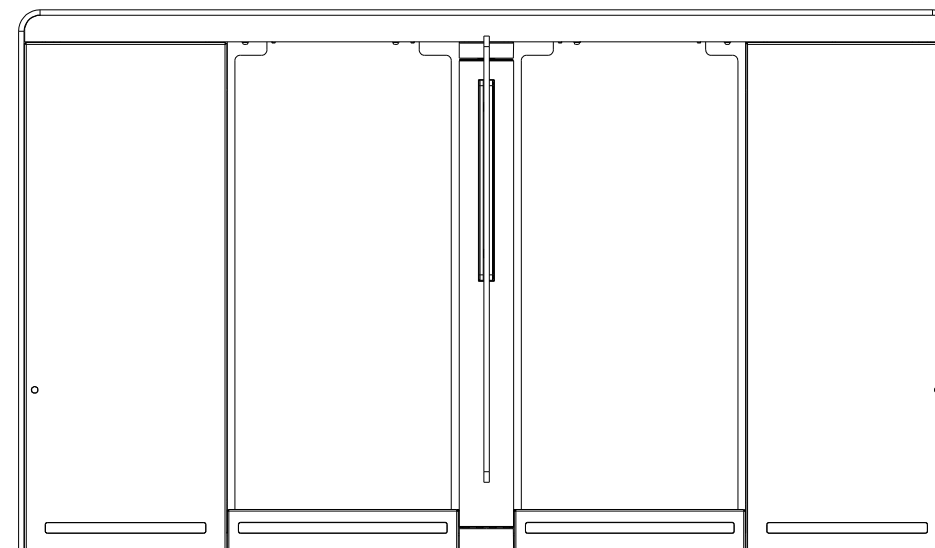
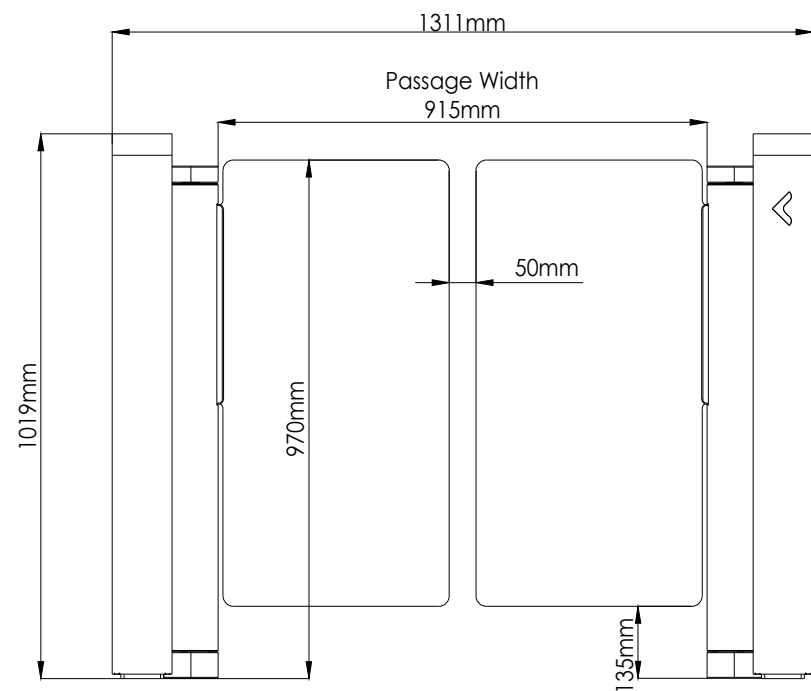

**ASSA ABLOY**

DRAWING NAME:

SG 400 CENTER GLASS 1750 / 915-970

DRAWING NUMBER:

CD-1191-02

DRAWN	DATE	SIZE	REV
F.C	04.06.2026	A4	Rev-001

SCALE: 1:1

SHEET: 1 OF 1

D

C

B

A

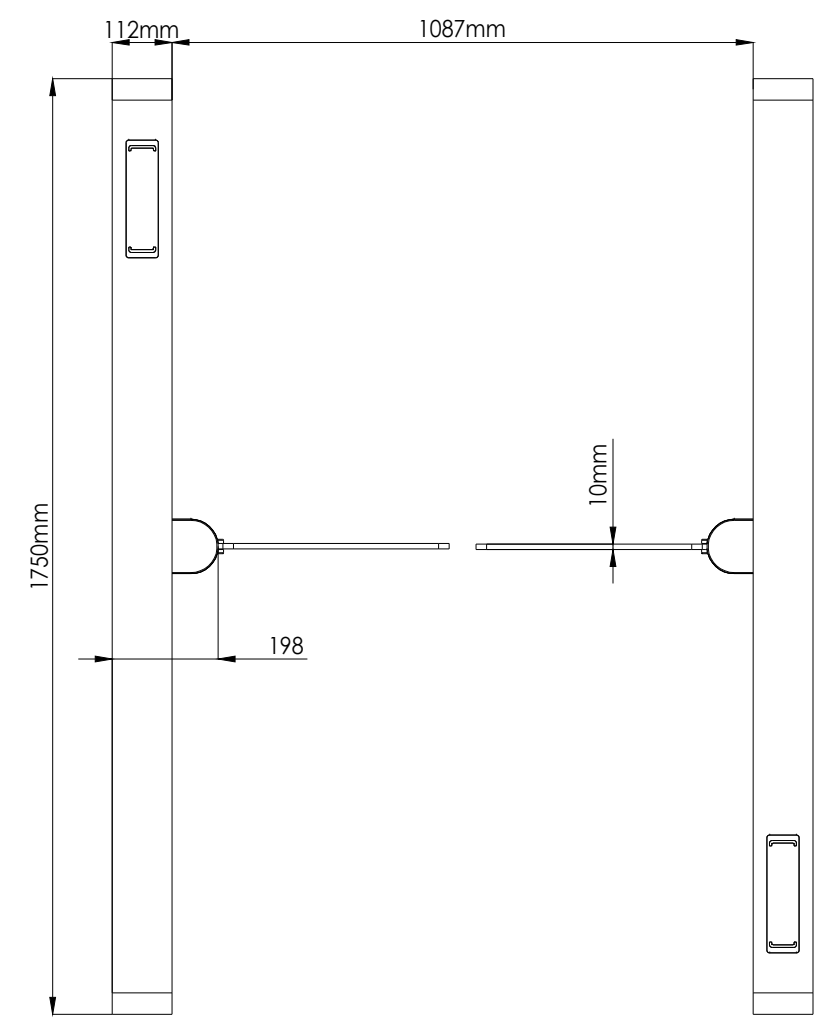
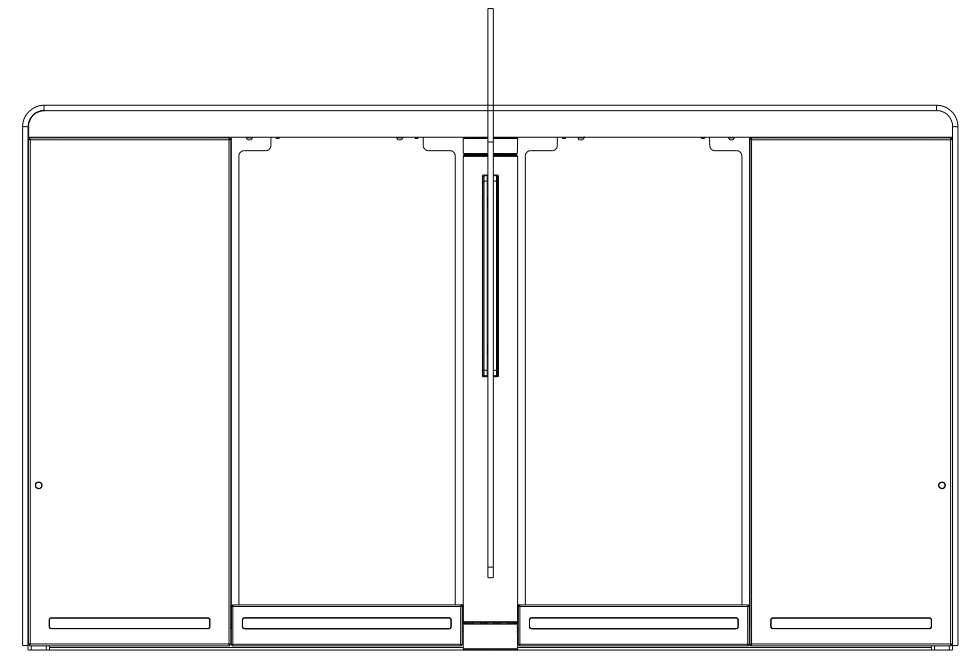
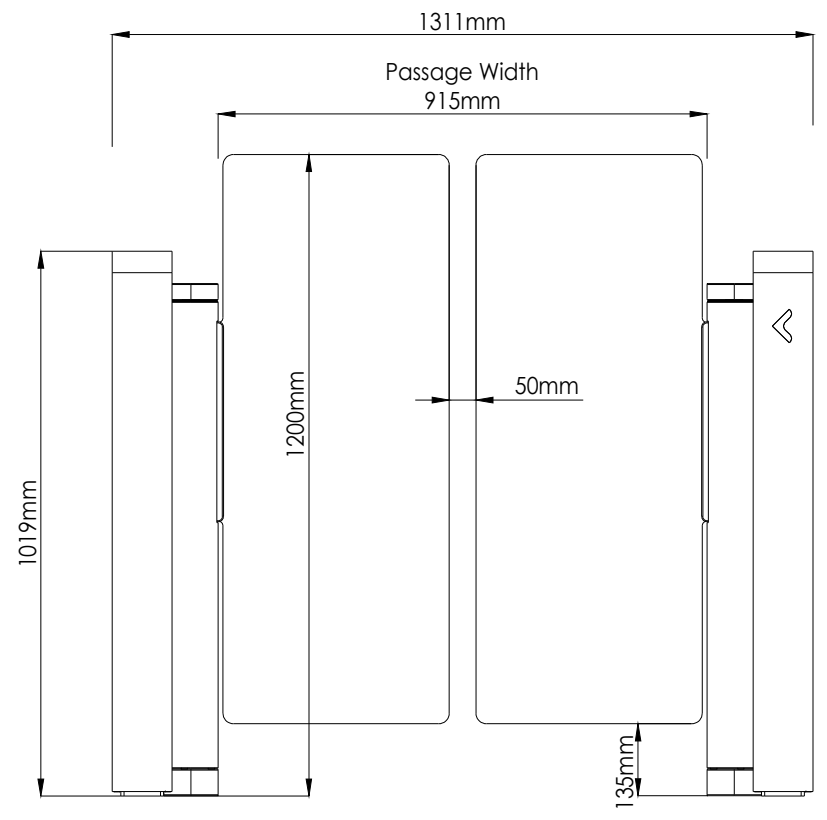

<b>ASSA ABLOY</b>			
DRAWING NAME: SG 400 CENTER GLASS 1750 / 915-1200			
DRAWING NUMBER: CD-1192-02			
DRAWN F.C	DATE 04.06.2026	SIZE A4	REV Rev-001
SCALE: 1:1		SHEET: 1 OF 1	

4

3

2

1

D

C

B

A

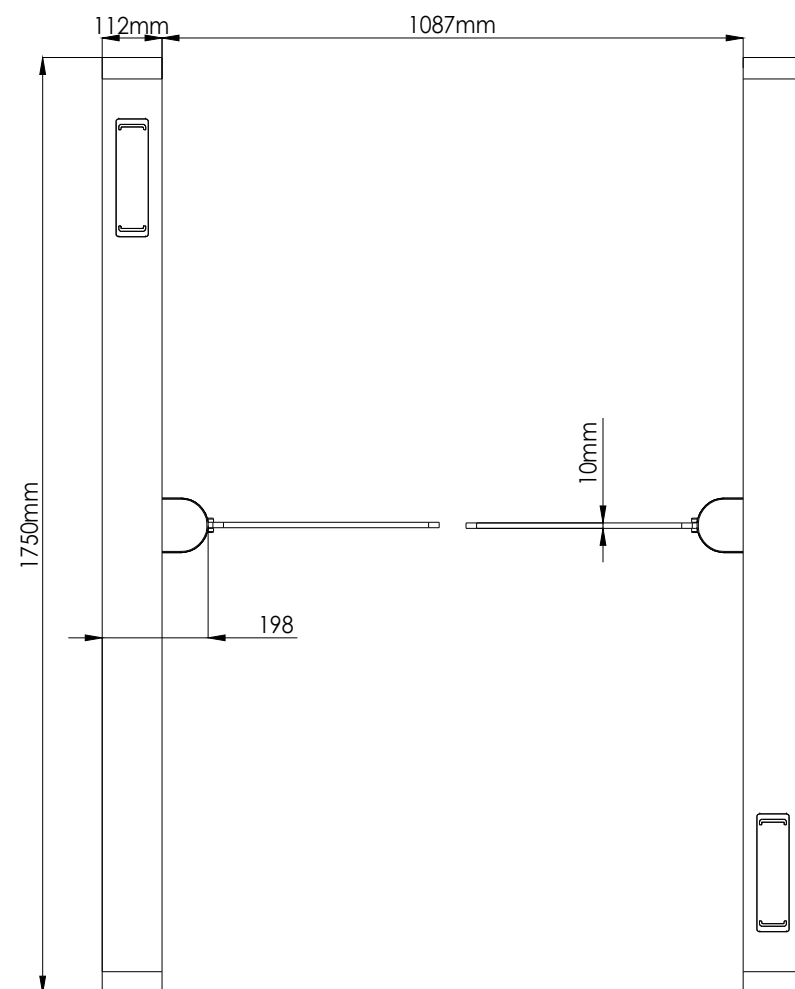
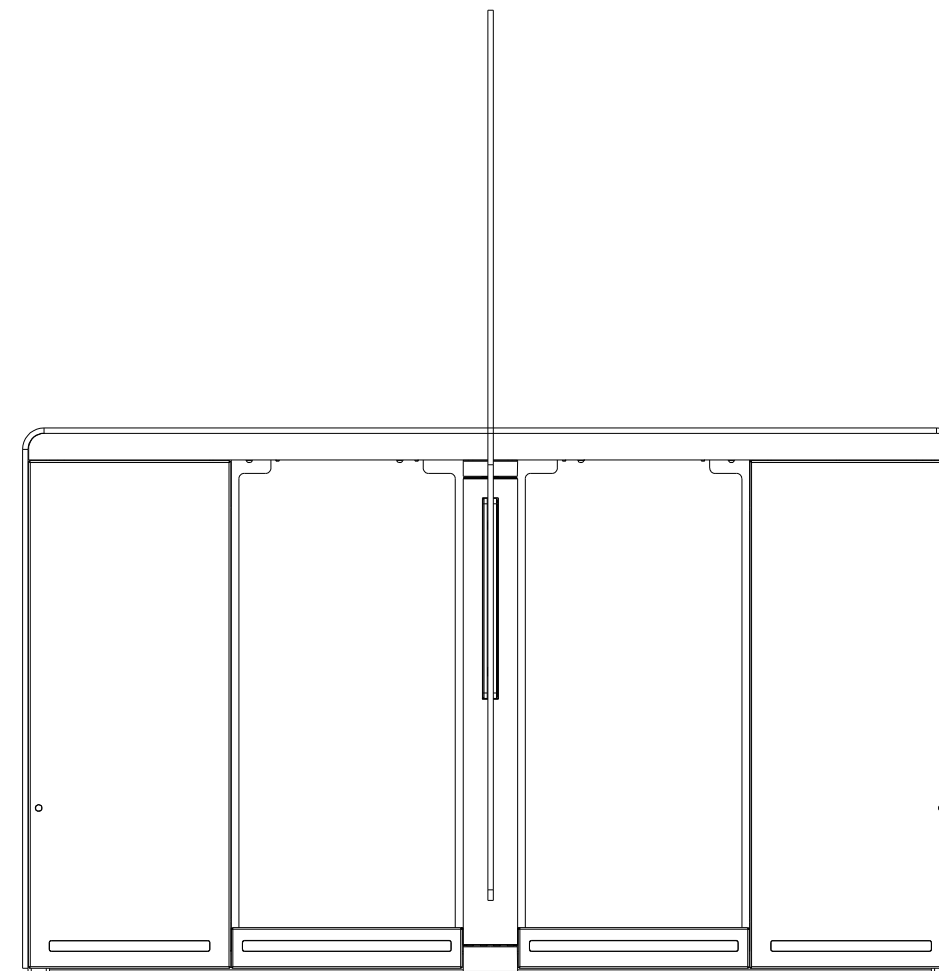
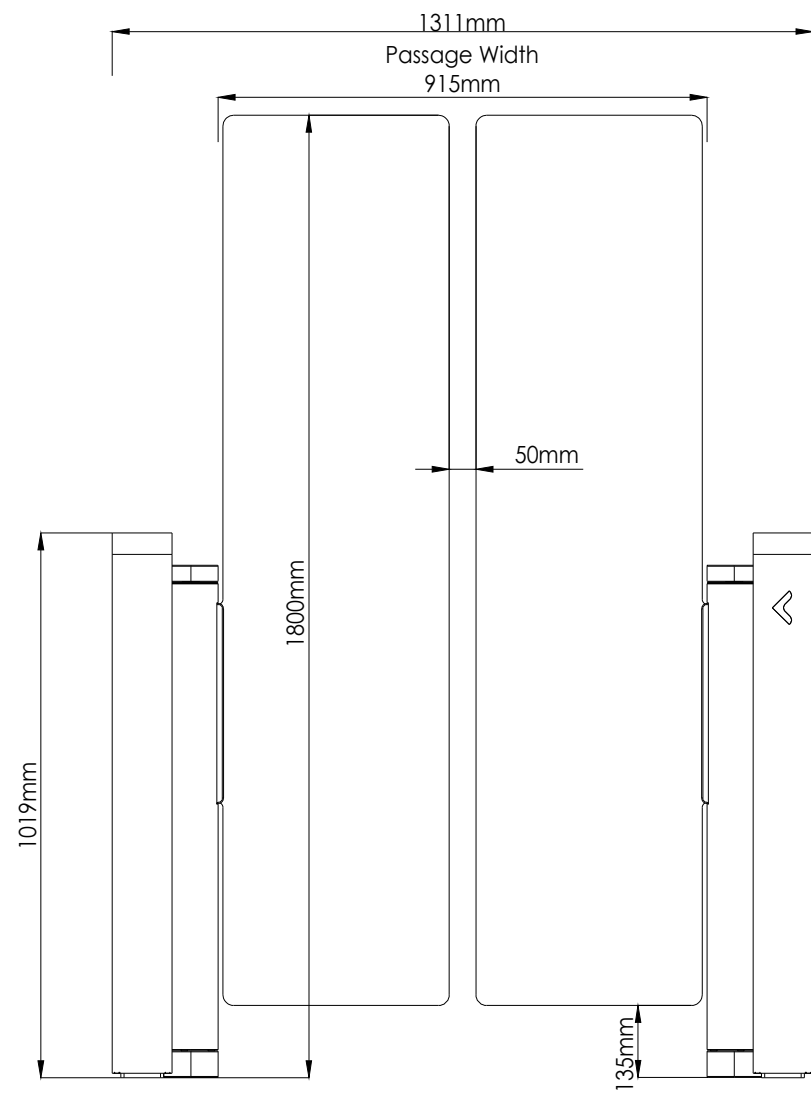

<b>ASSA ABLOY</b>			
DRAWING NAME: SG 400 CENTER GLASS 1750 / 915-1800			
DRAWING NUMBER: CD-1193-02			
DRAWN F.C	DATE 04.06.2026	SIZE A4	REV Rev-001
SCALE: 1:1		SHEET: 1 OF 1	

D

C

B

A

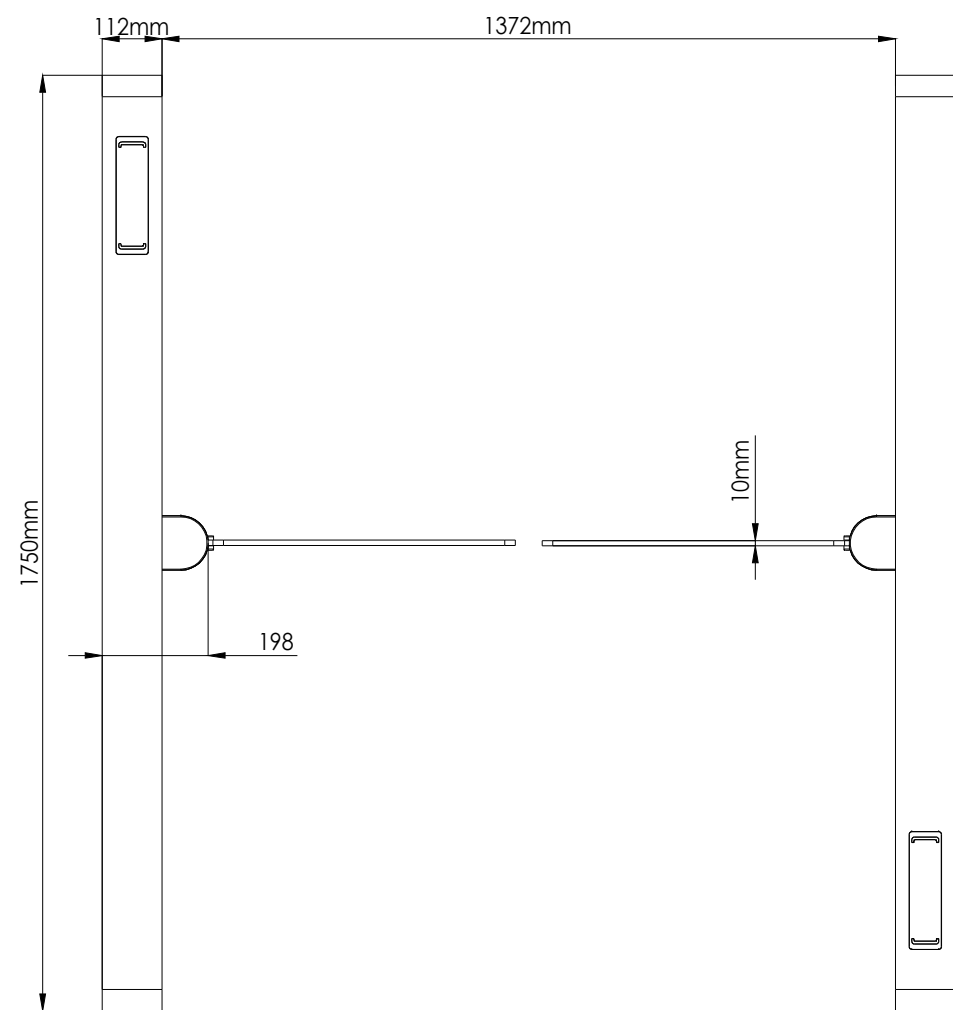
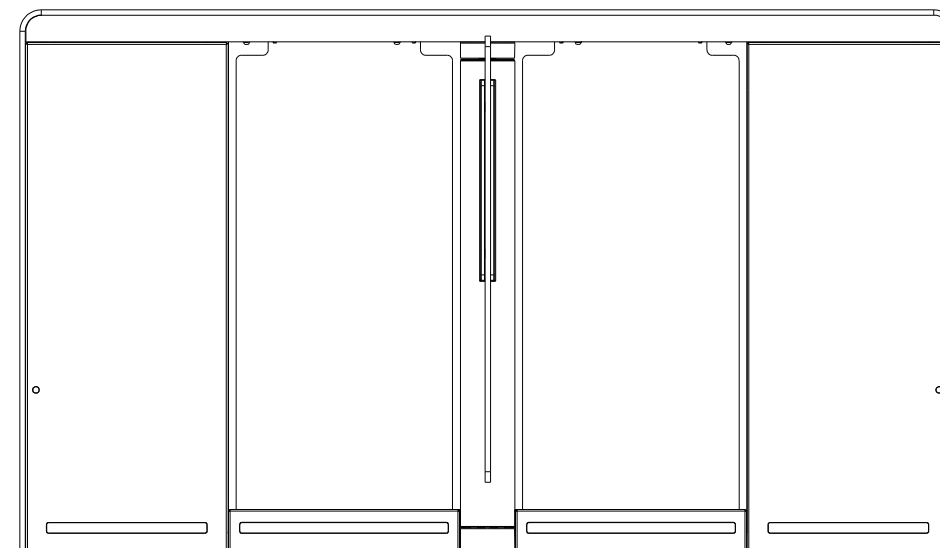
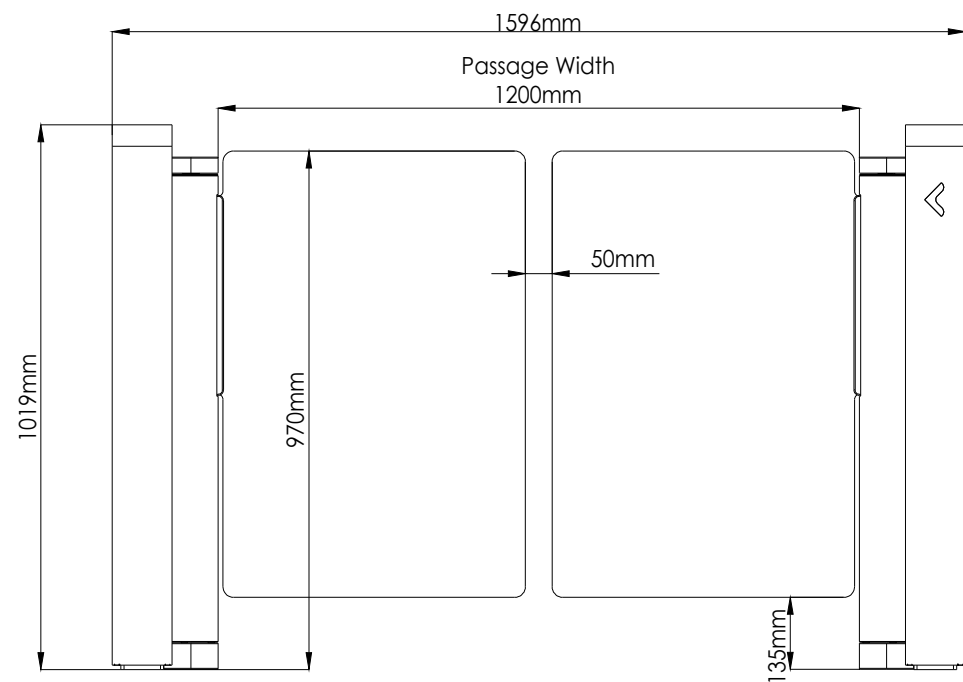

# ASSA ABLOY

DRAWING NAME:  
SG 400 CENTER GLASS 1750 / 1200-970

DRAWING NUMBER:  
CD-1194-02

DRAWN	DATE	SIZE	REV
F.C	04.06.2026	A4	Rev-001

D

C

B

A

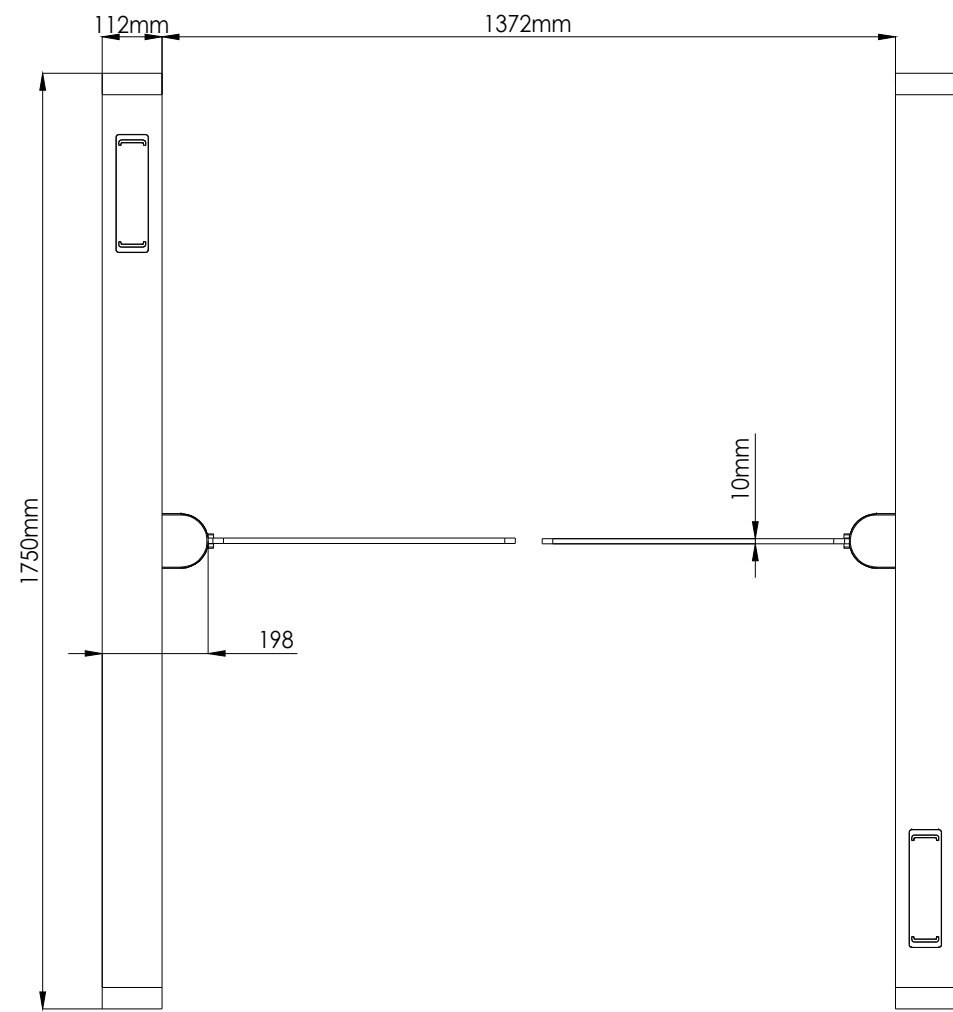
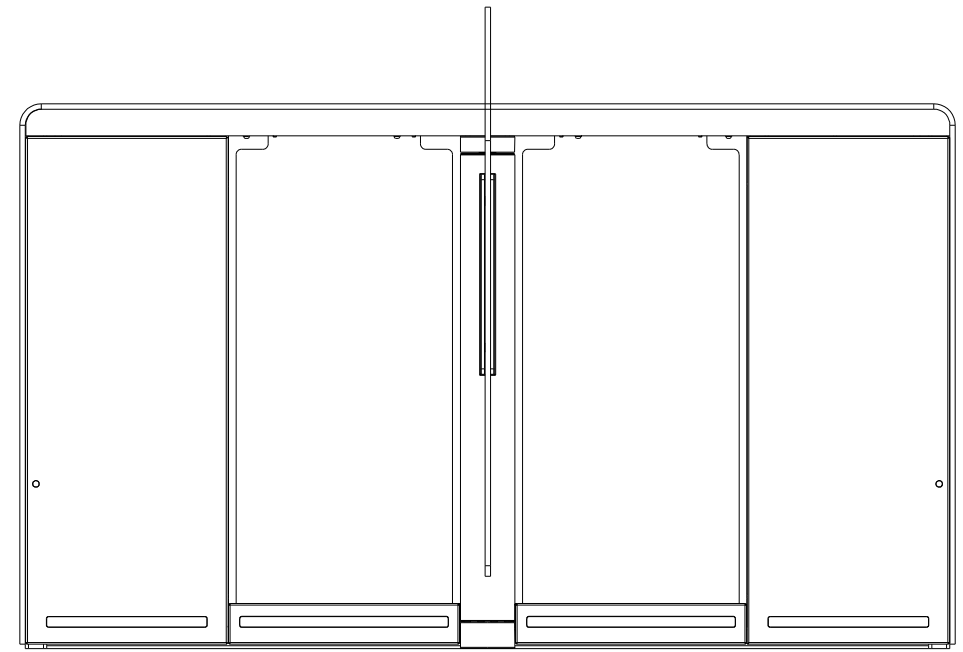
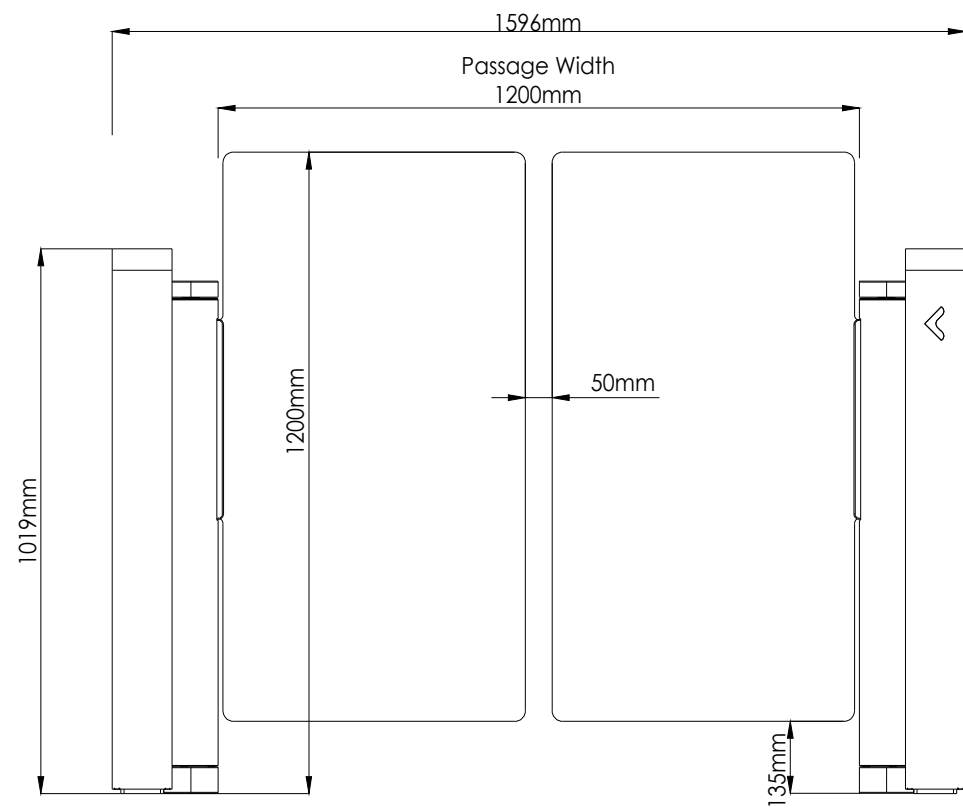

<b>ASSA ABLOY</b>			
DRAWING NAME: SG 400 CENTER GLASS 1750 / 1200-1200			
DRAWING NUMBER: CD-1195-02			
DRAWN F.C	DATE 04.06.2026	SIZE A4	REV Rev-001
SCALE: 1:1		SHEET: 1 OF 1	

4

3

2

1

D

C

B

A

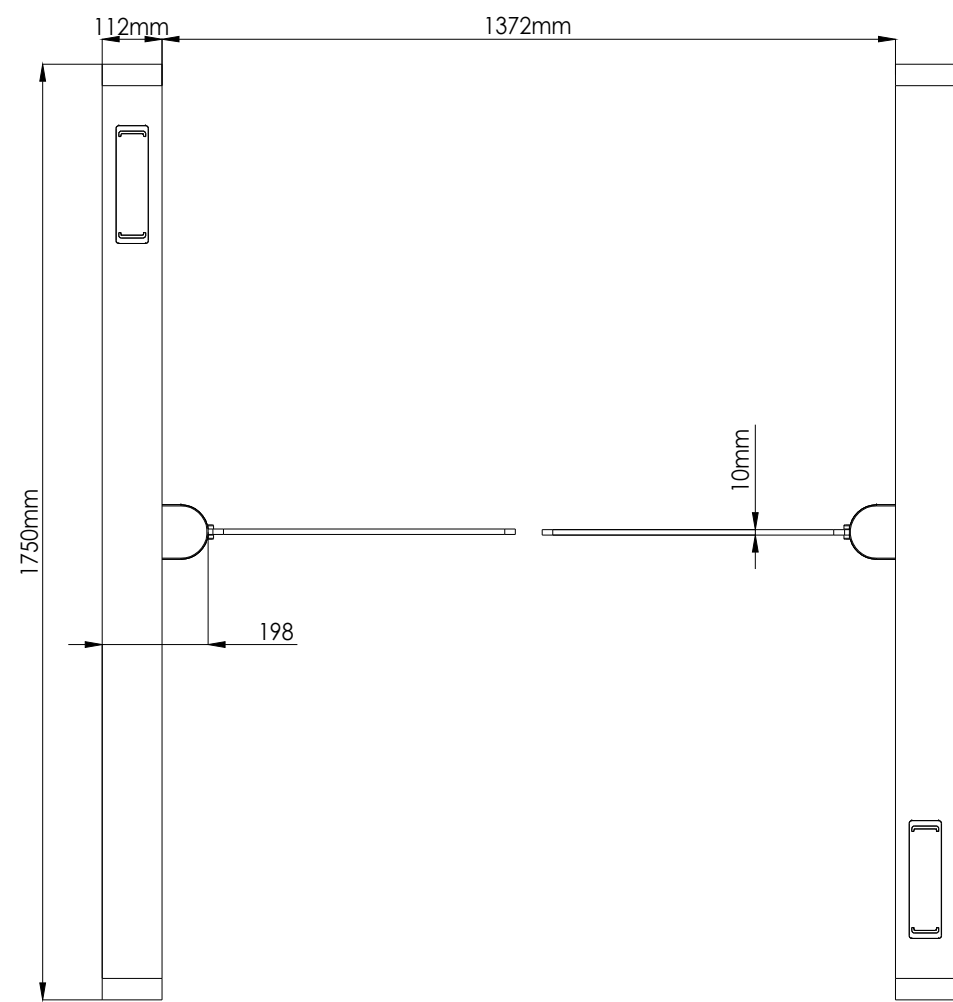
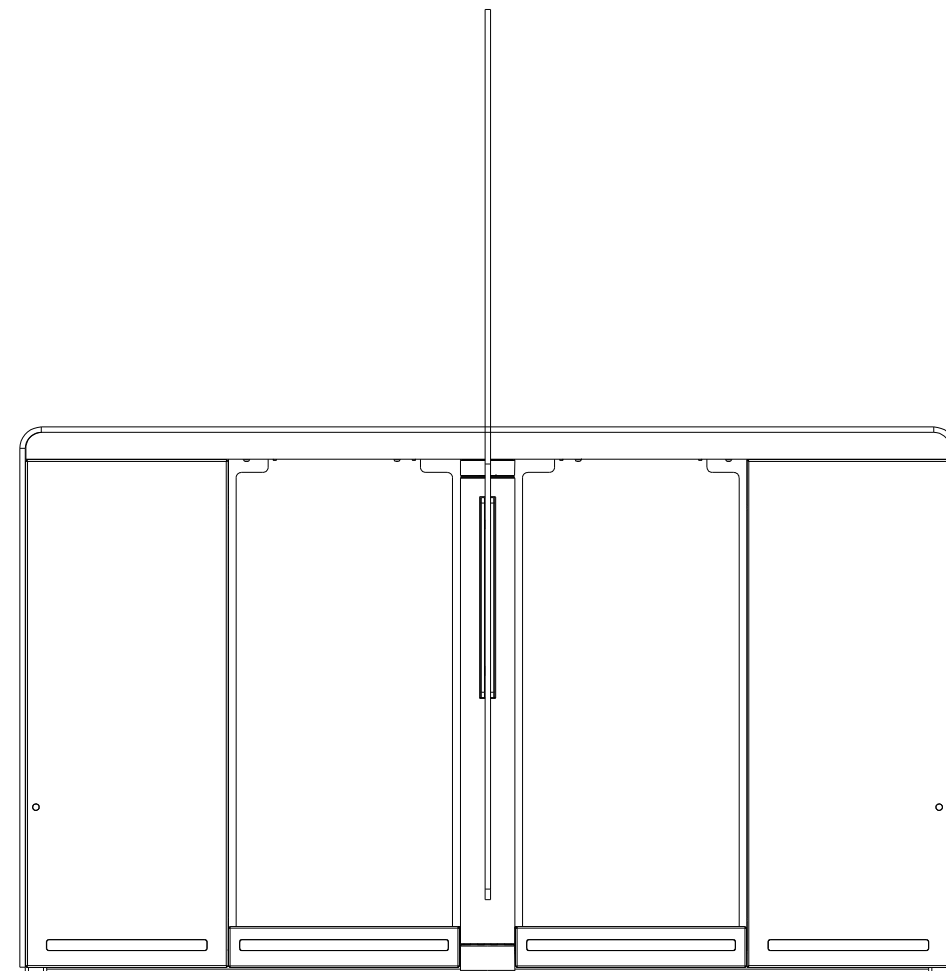
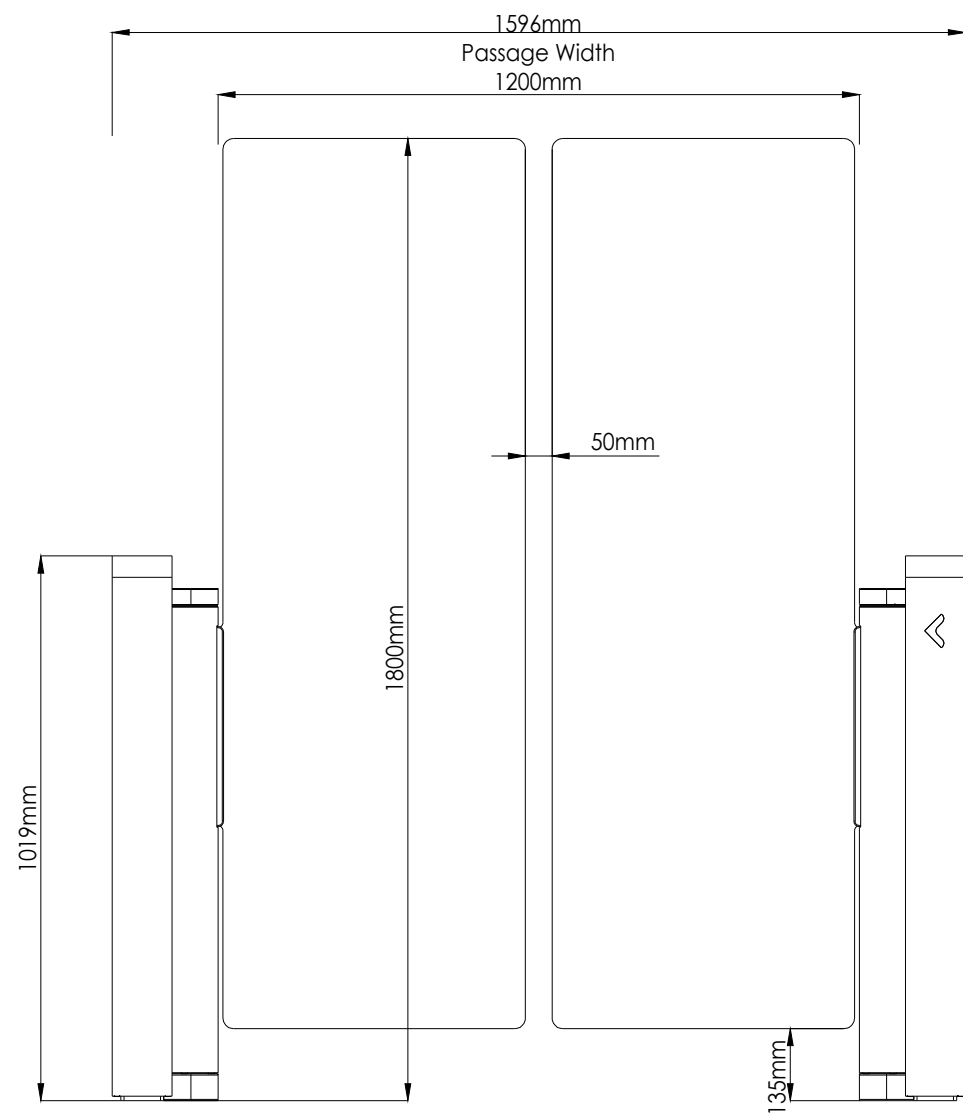

**ASSA ABLOY**

DRAWING NAME:  
SG 400 CENTER GLASS 1750 / 1200-1800

DRAWING NUMBER:  
CD-1196-02

DRAWN	DATE	SIZE	REV
F.C	04.06.2026	A4	Rev-001

SCALE: 1:1 SHEET: 1 OF 1

D

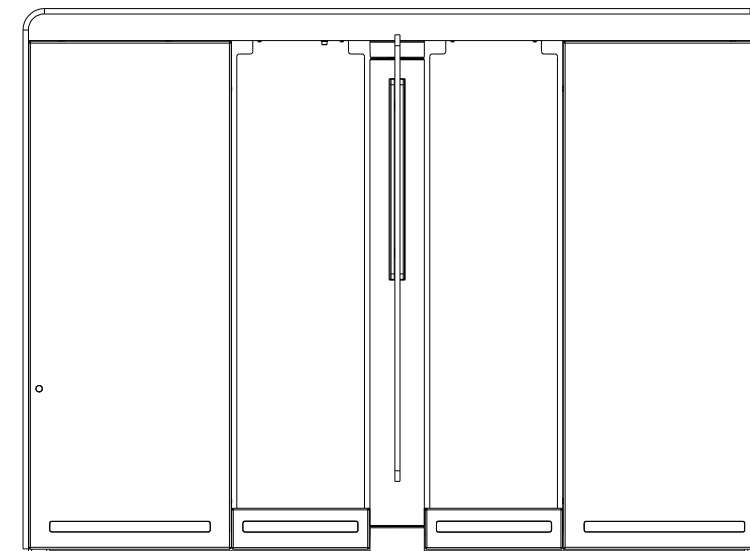
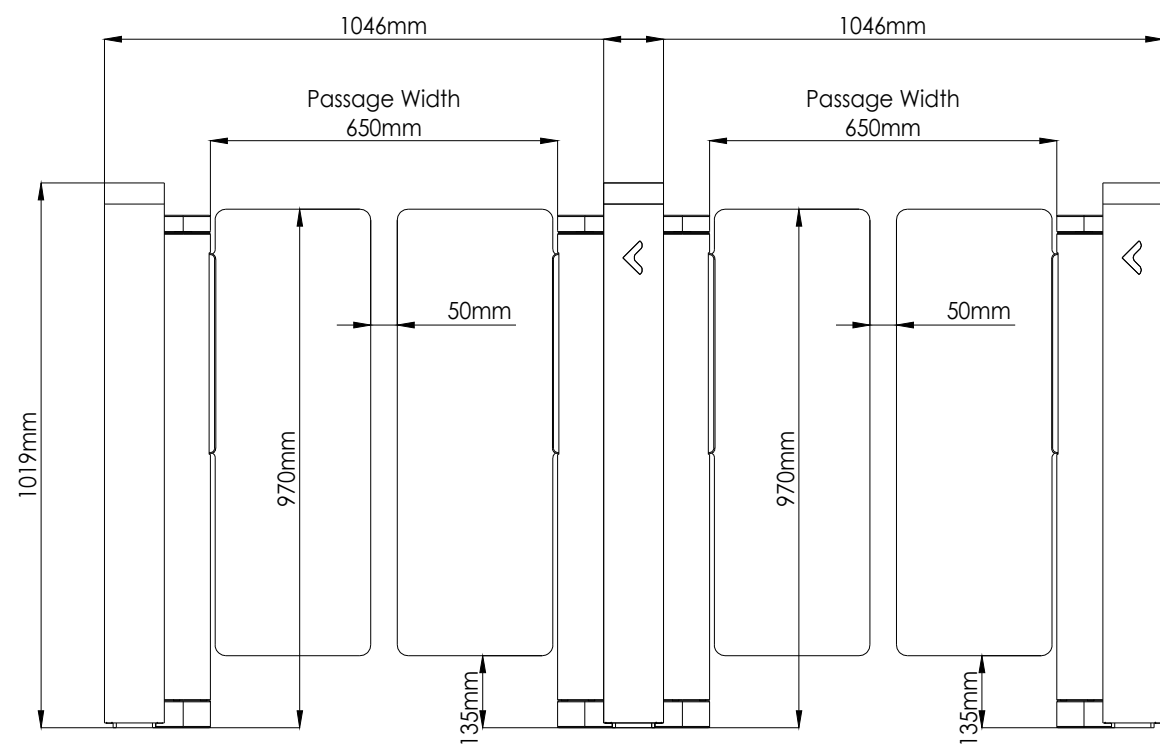

C

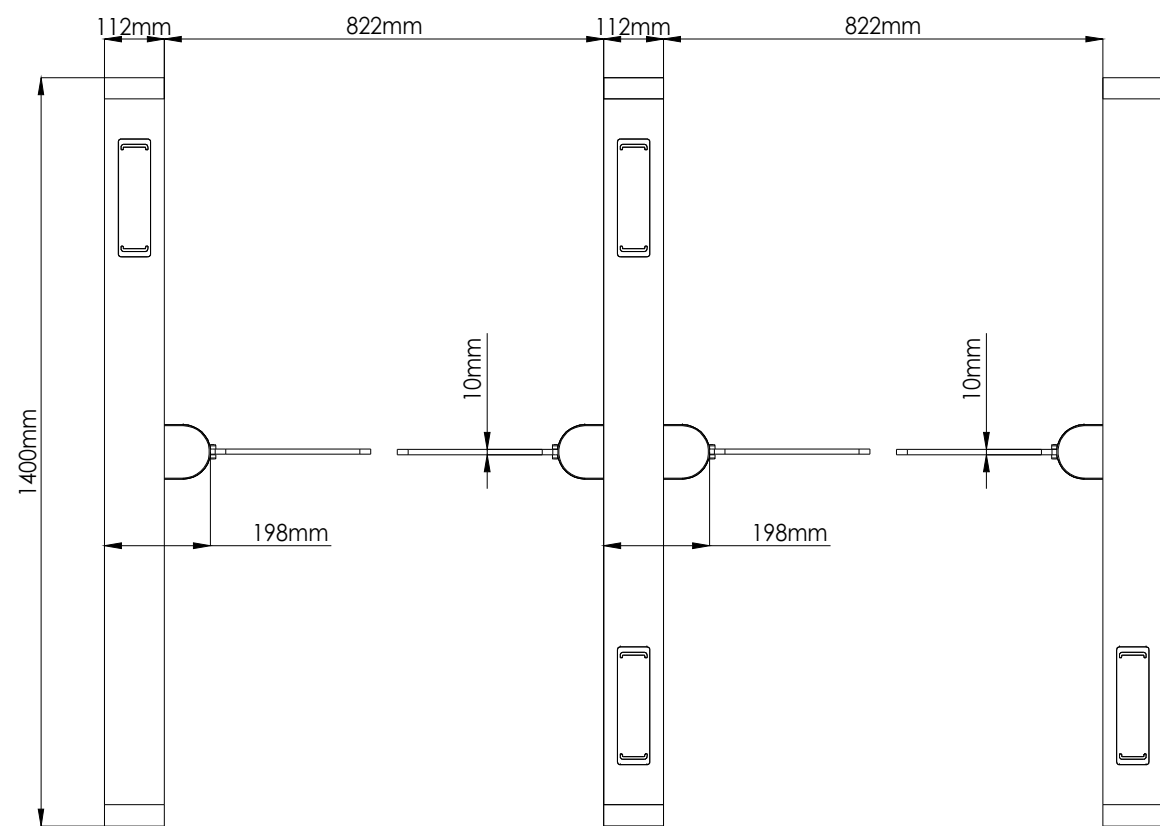

B

A

**ASSA ABLOY**

DRAWING NAME:  
SG 400 CENTER GLASS 1400 / 650-650-970

DRAWING NUMBER:  
CD-1197-02

DRAWN	DATE	SIZE	REV
F.C	04.06.2026	A4	Rev-001

SCALE: 1:1 SHEET: 1 OF 1

D

C

B

A

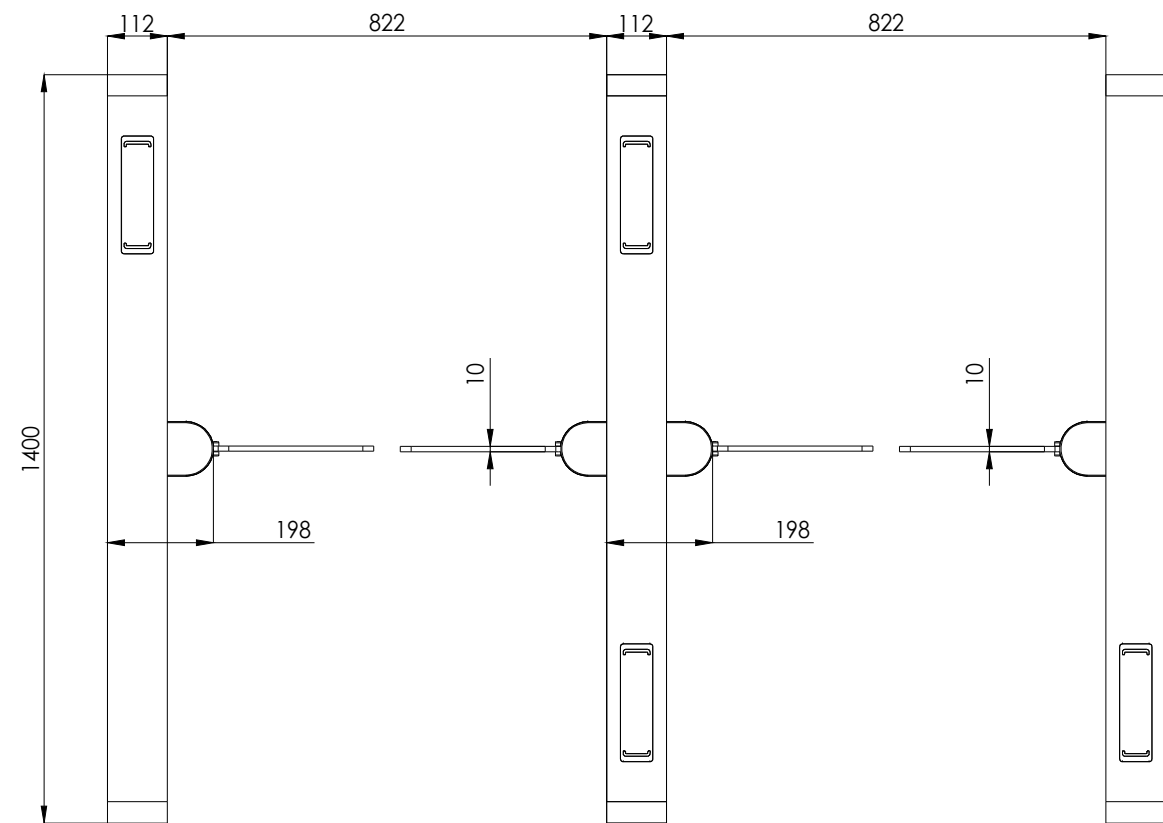
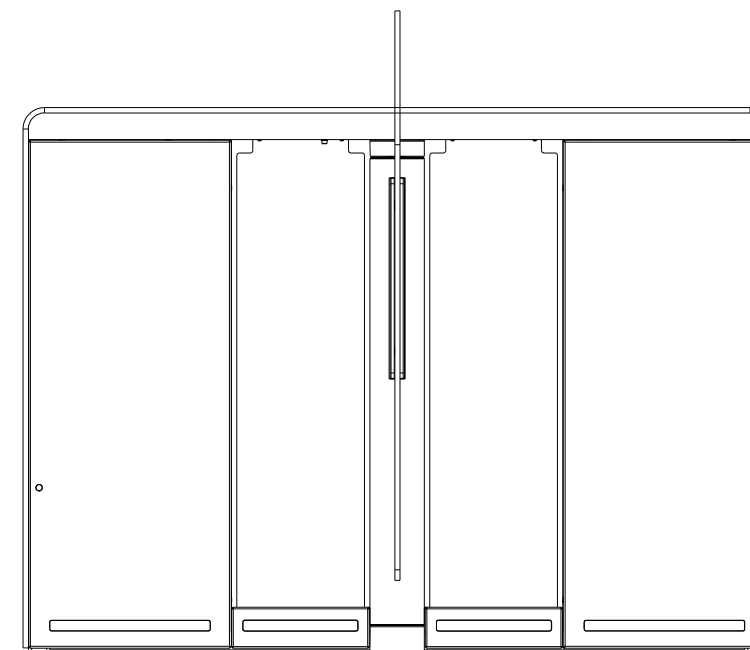
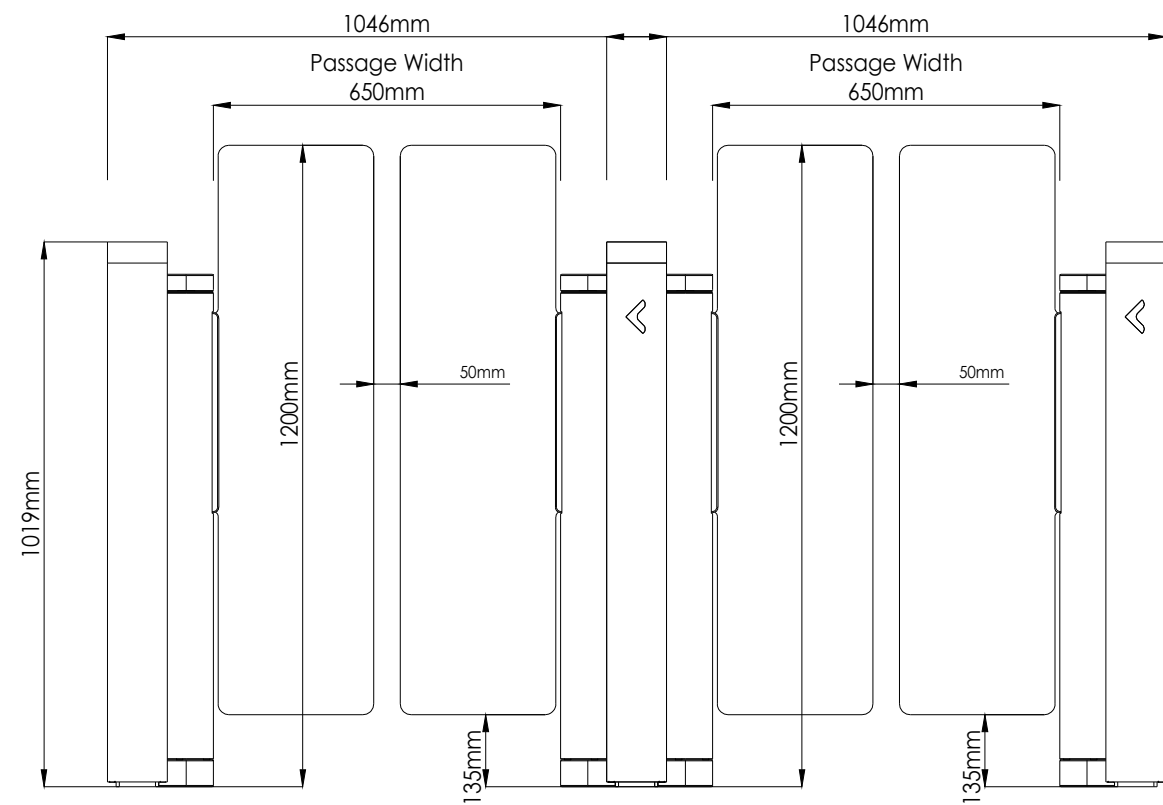

<b>ASSA ABLOY</b>			
DRAWING NAME: SG 400 CENTER GLASS 1400 / 650-650-1200			
DRAWING NUMBER: CD-1198-02			
DRAWN F.C	DATE 04.06.2026	SIZE A4	REV Rev-001
SCALE: 1:1		SHEET: 1 OF 1	

D

C

B

A

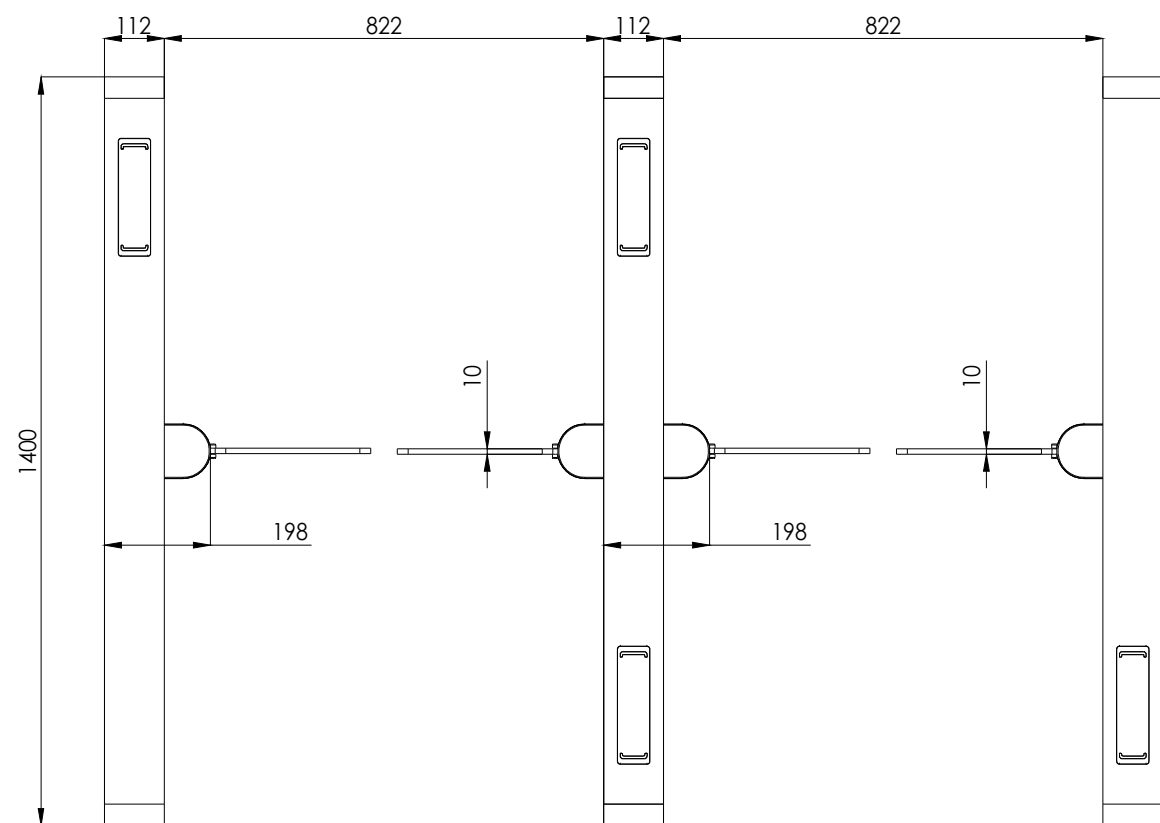
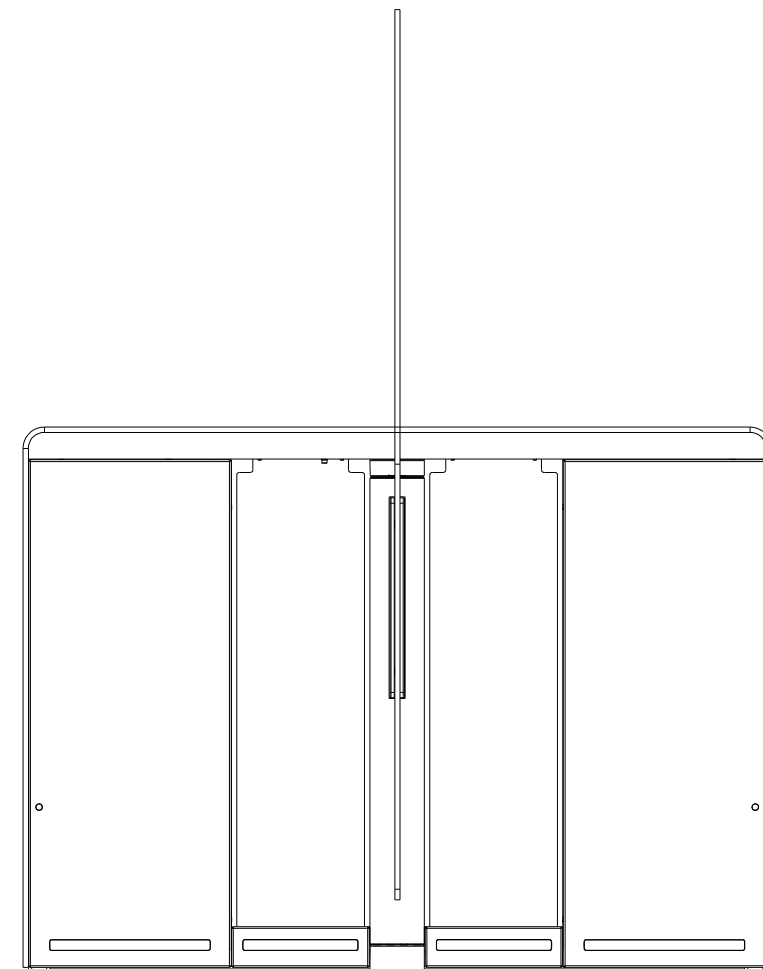
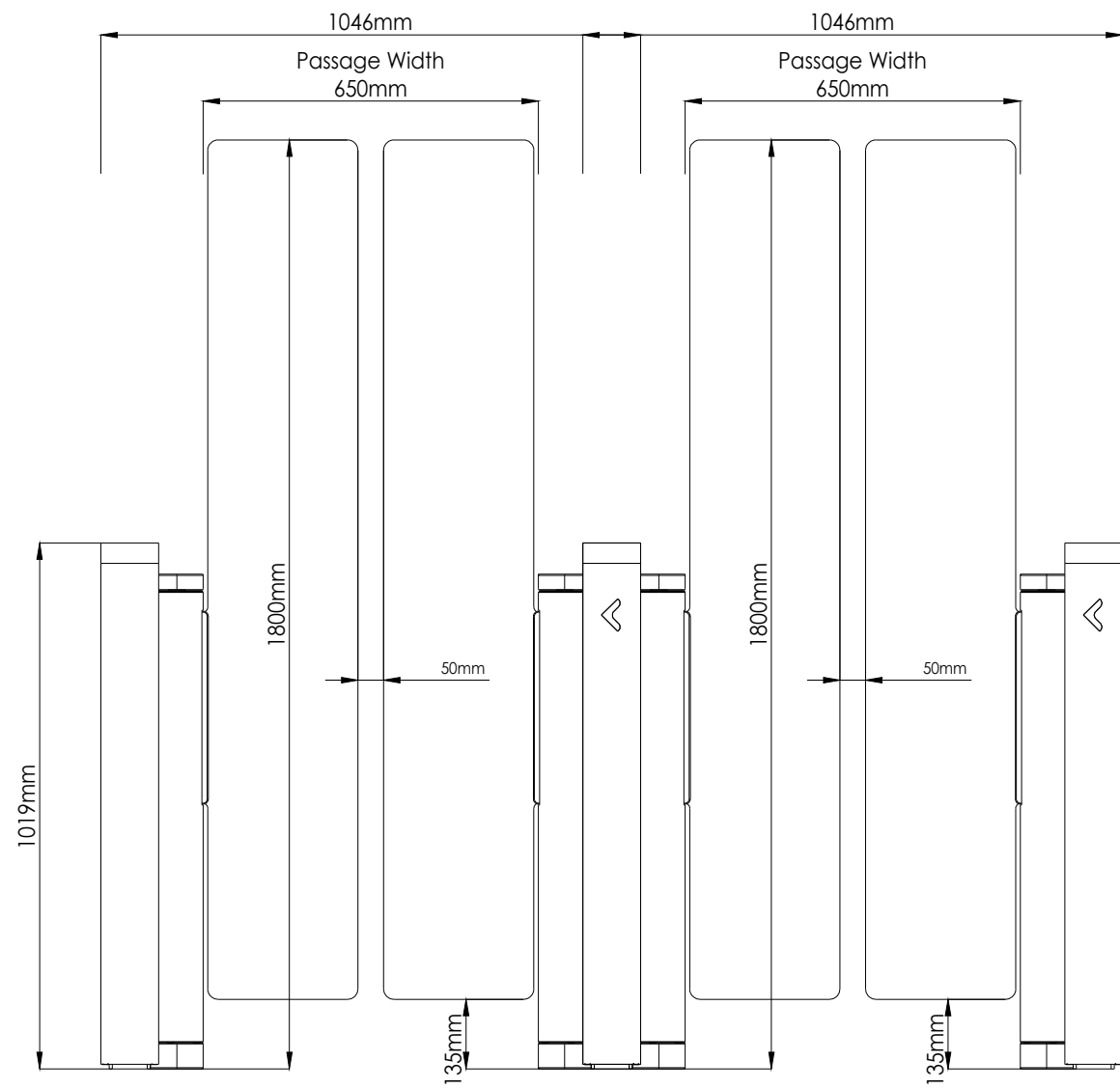

**ASSA ABLOY**

DRAWING NAME:  
SG 400 CENTER GLASS 1400 / 650-650-1800

DRAWING NUMBER:  
CD-1199-02

DRAWN F.C	DATE 04.06.2026	SIZE A4	REV Rev-001
--------------	--------------------	------------	----------------

SCALE: 1:1 SHEET: 1 OF 1

D

C

B

A

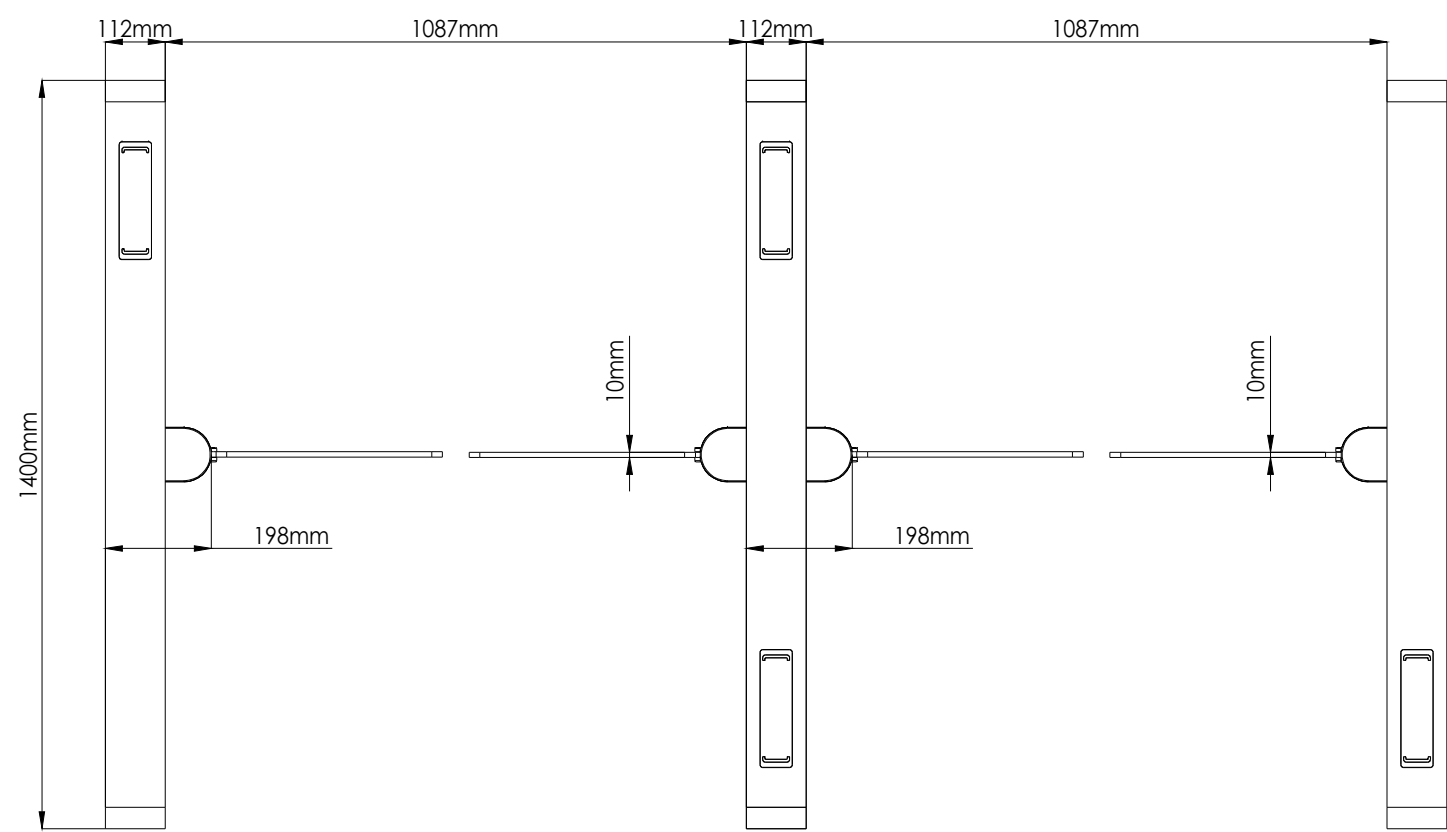
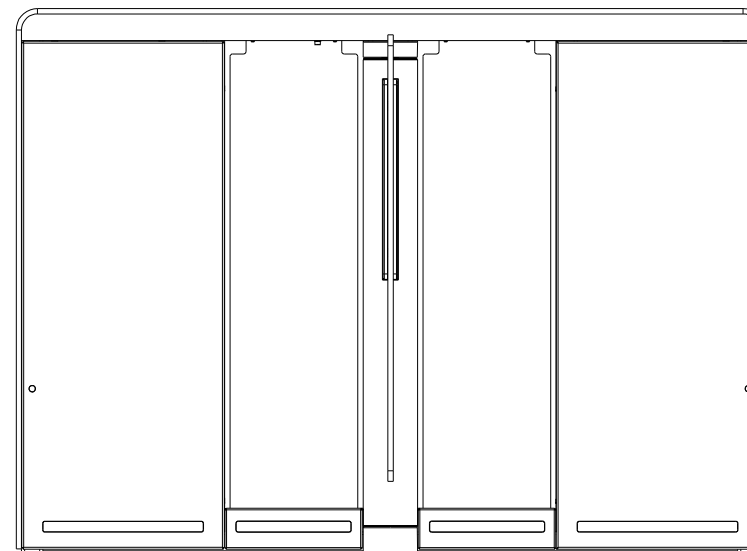
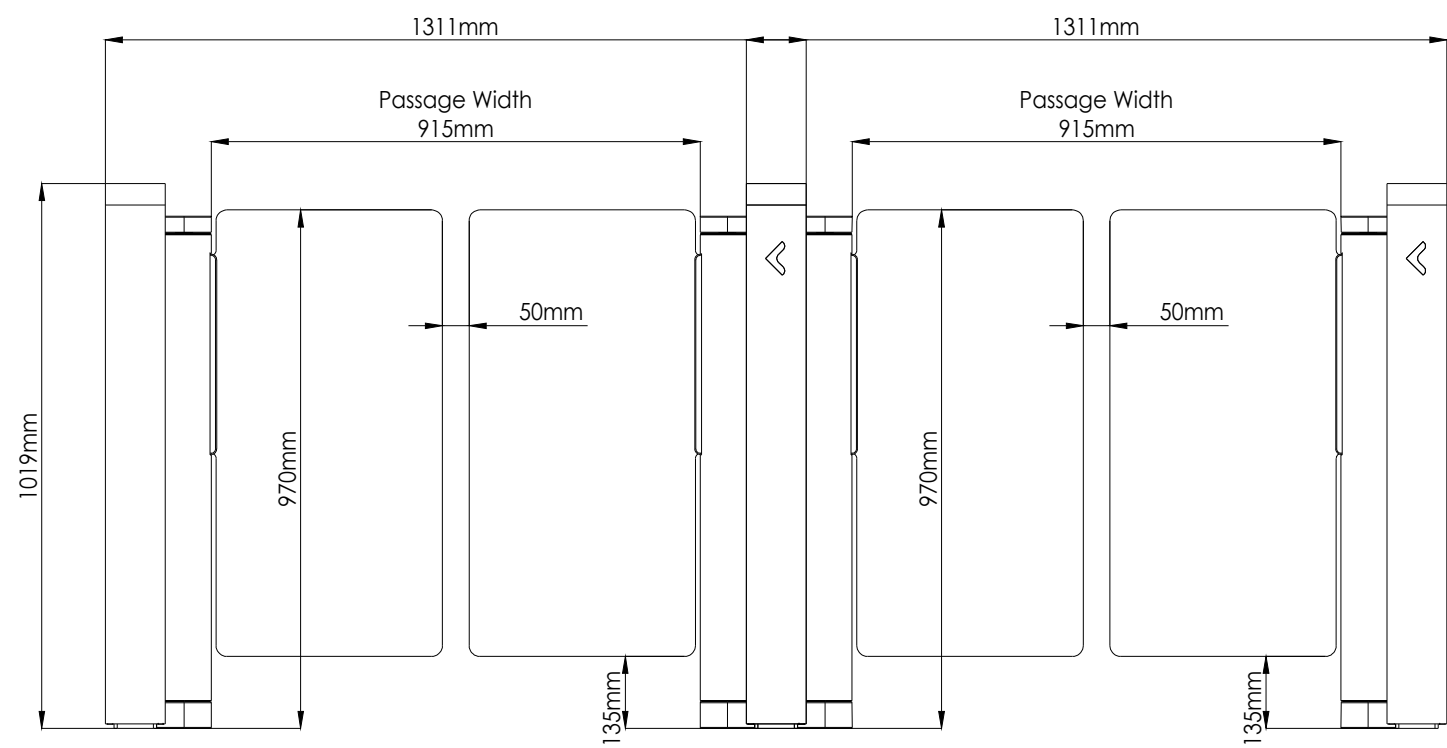

<b>ASSA ABLOY</b>			
DRAWING NAME: SG 400 CENTER GLASS 1400 / 915-915-970			
DRAWING NUMBER: CD-1200-02			
DRAWN F.C	DATE 04.06.2026	SIZE A4	REV Rev-001
SCALE: 1:1		SHEET: 1 OF 1	

D

C

B

A

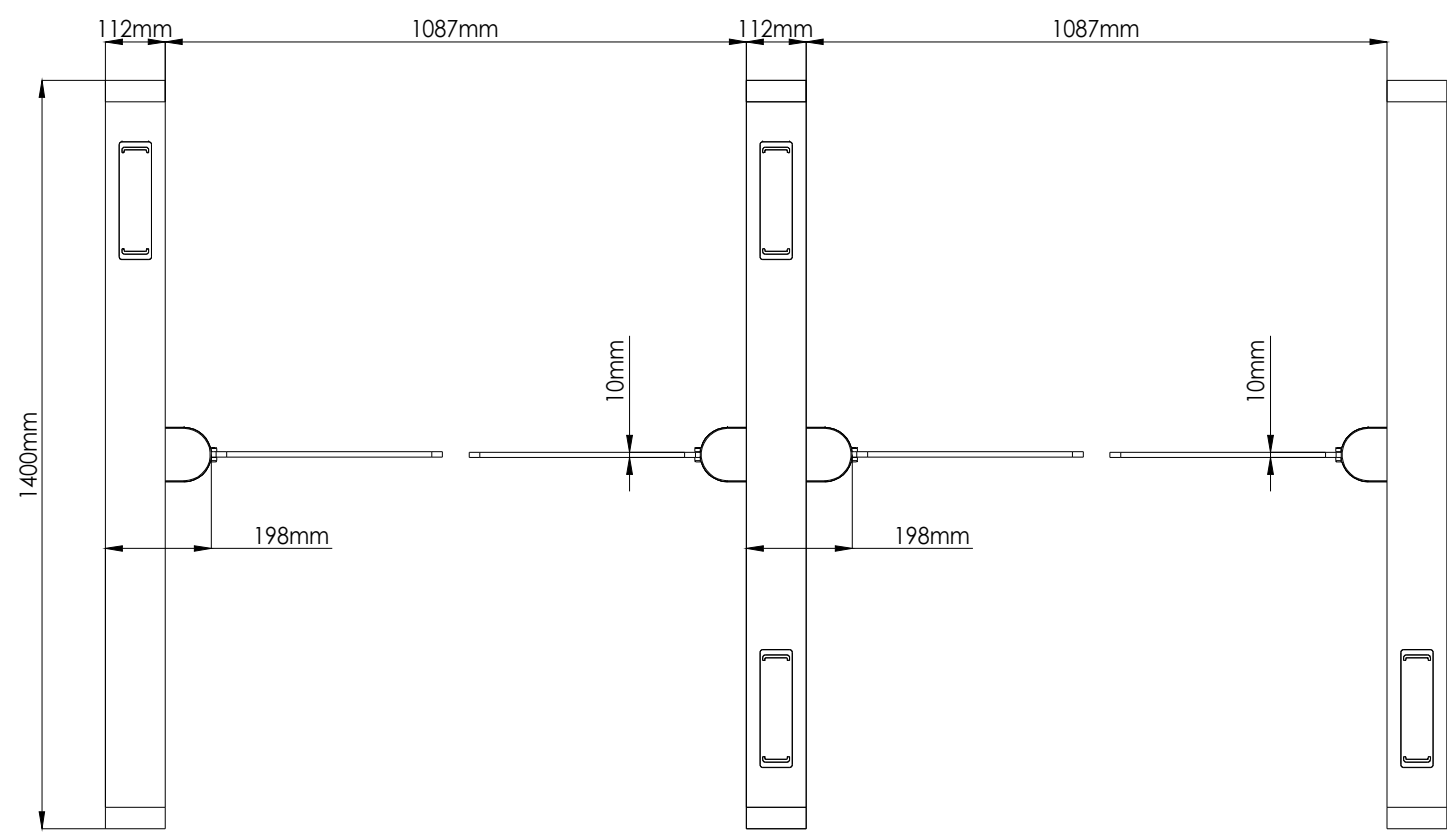
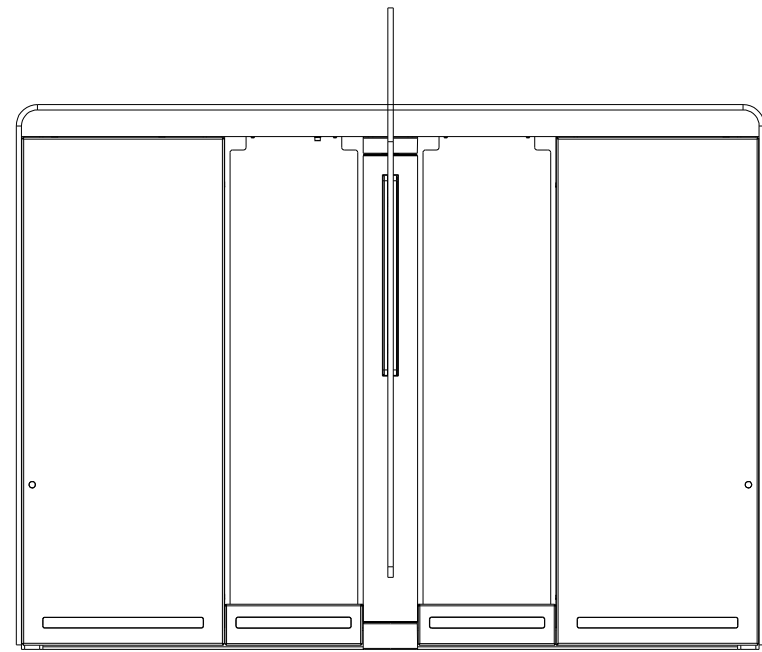
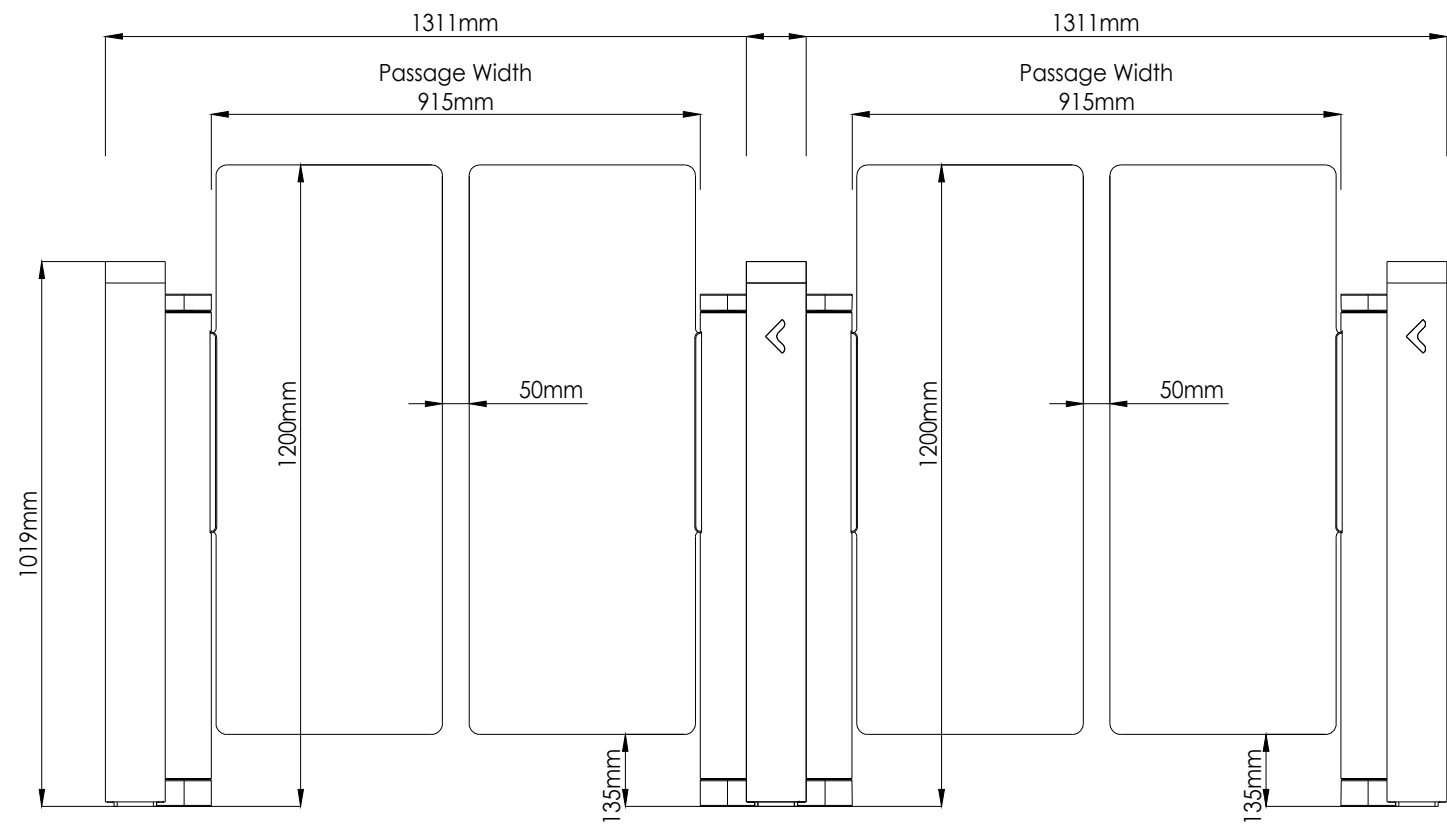

<b>ASSA ABLOY</b>			
DRAWING NAME: SG 400 CENTER GLASS 1400 / 915-915-1200			
DRAWING NUMBER: CD-1201-02			
DRAWN F.C	DATE 04.06.2026	SIZE A4	REV Rev-001
SCALE: 1:1		SHEET: 1 OF 1	

4

3

2

1

D

C

B

A

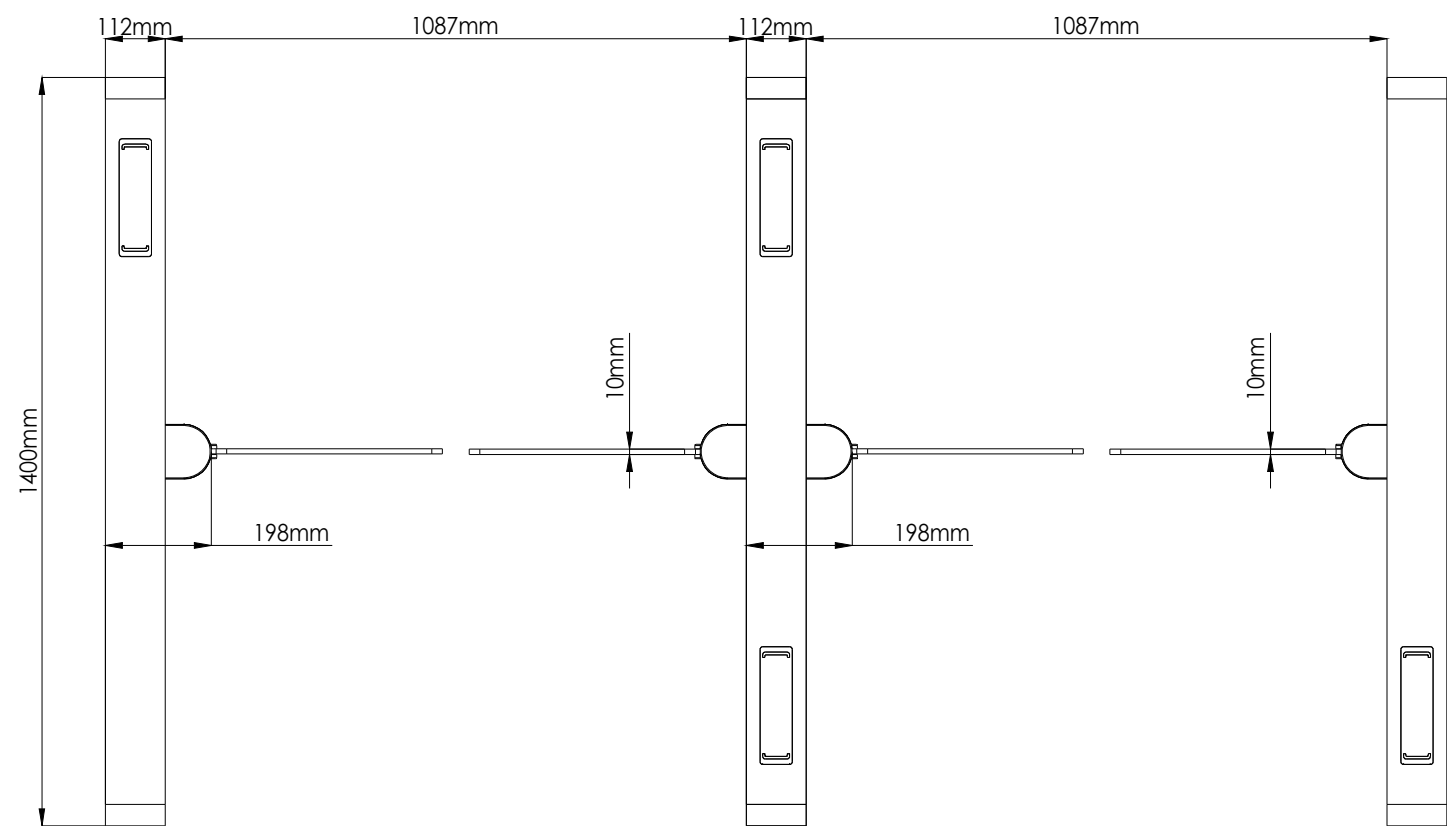
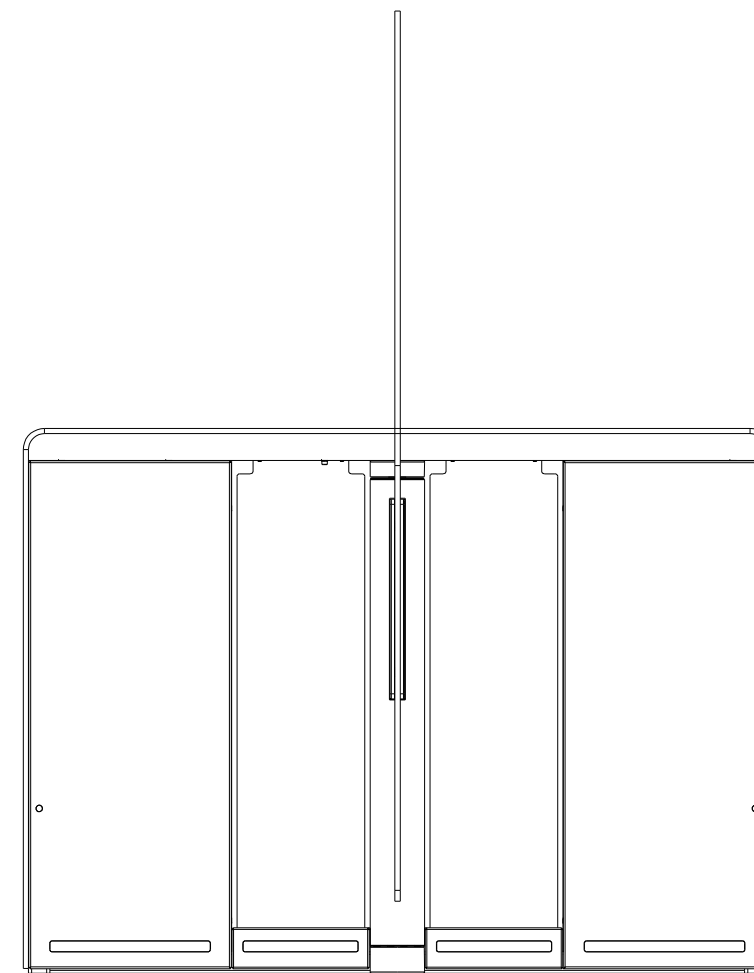
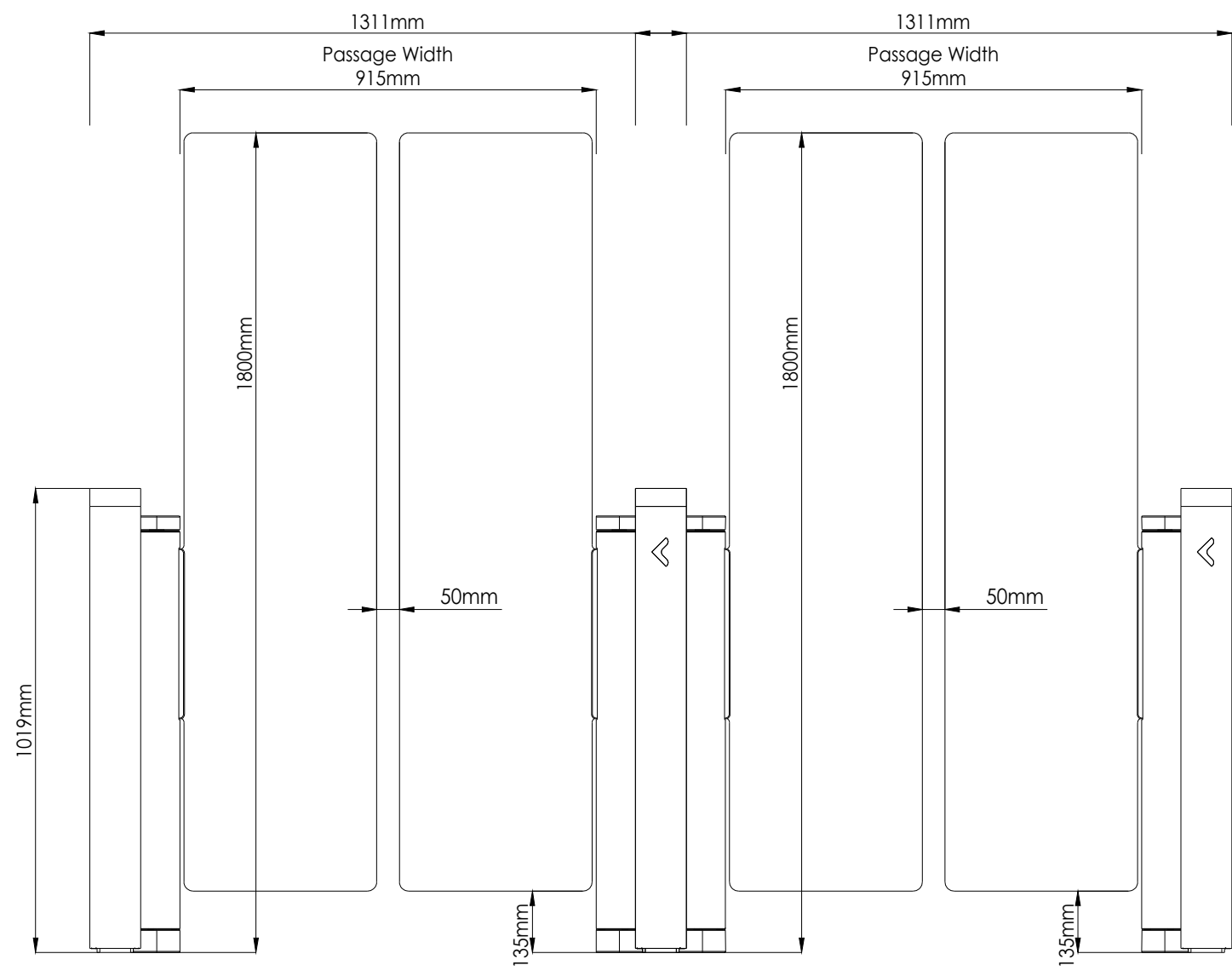

<b>ASSA ABLOY</b>			
DRAWING NAME: SG 400 CENTER GLASS 1400 / 915-915-1800			
DRAWING NUMBER: CD-1202-02			
DRAWN F.C	DATE 04.06.2026	SIZE A4	REV Rev-001
SCALE: 1:1		SHEET: 1 OF 1	

D

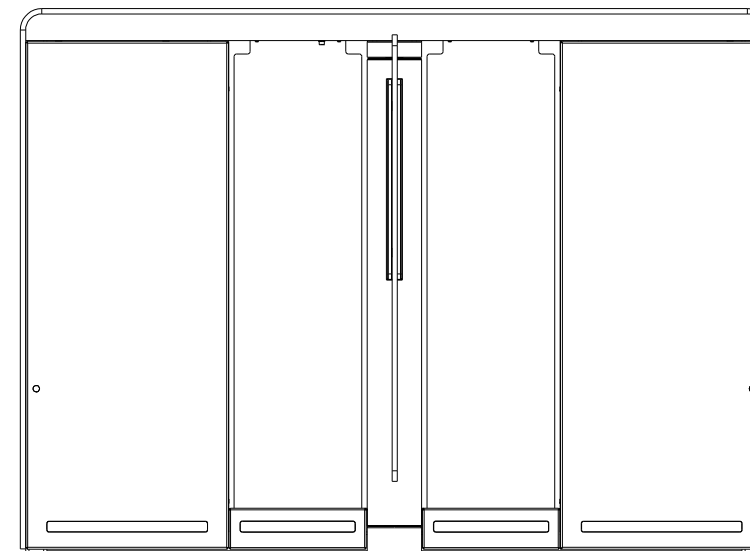
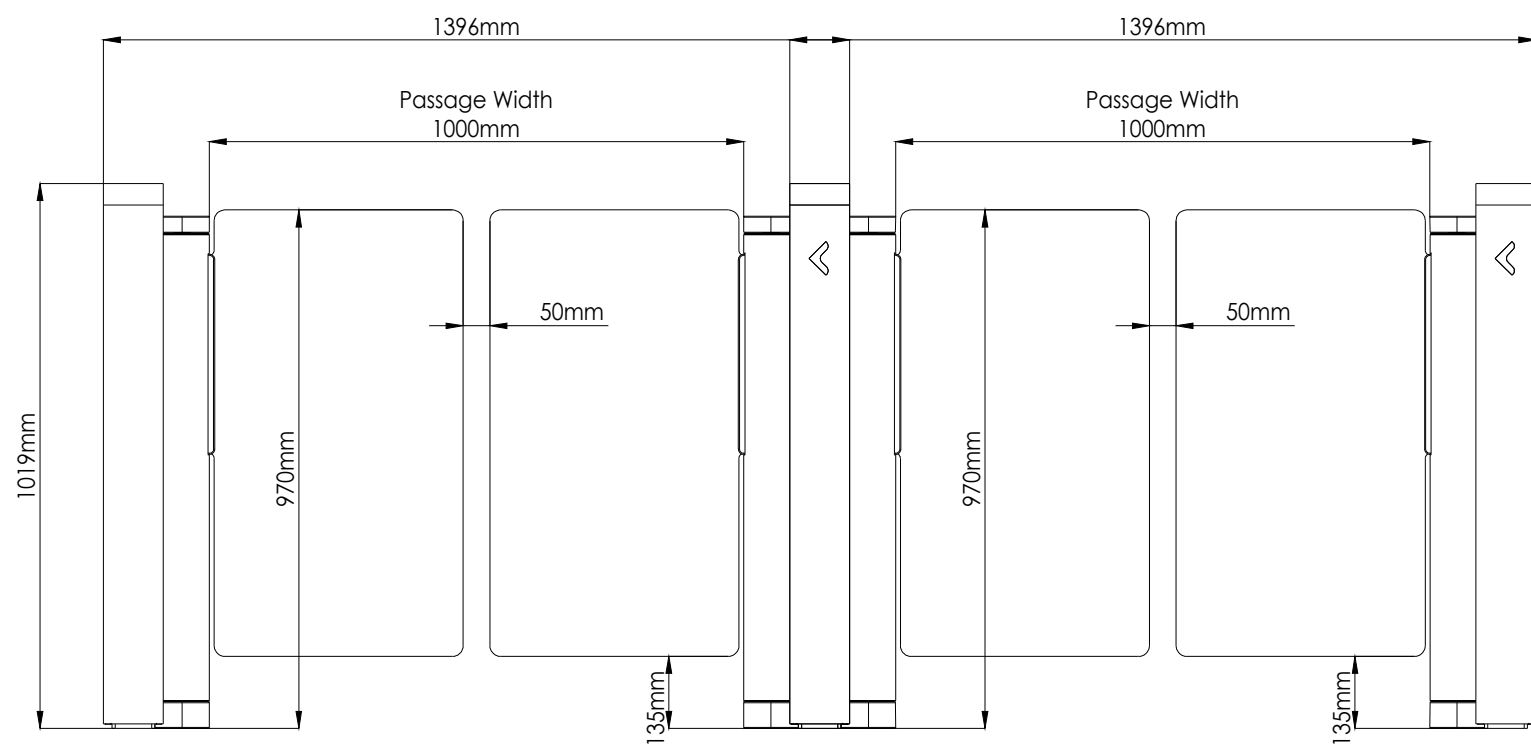

C

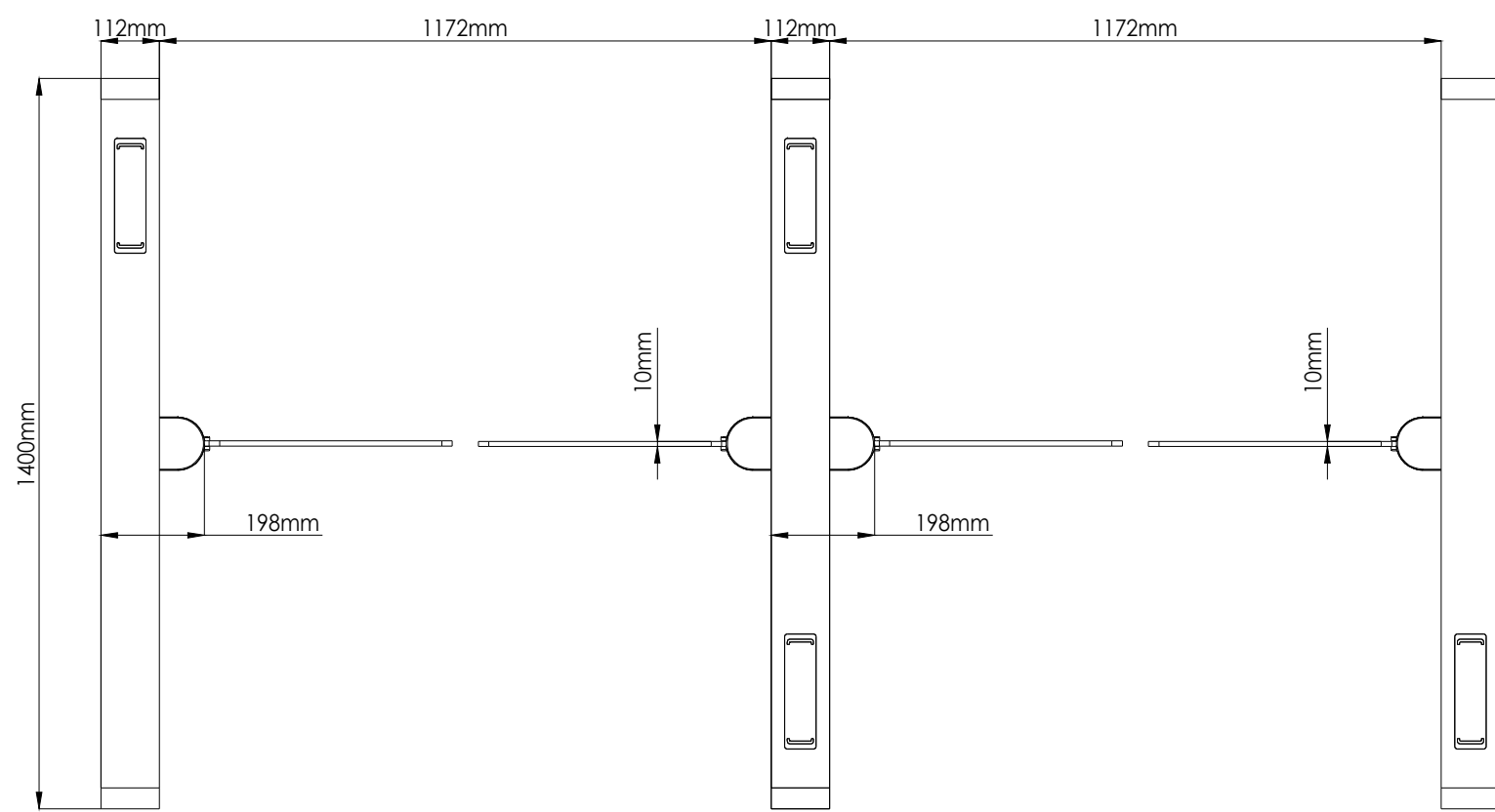

B

A

<b>ASSA ABLOY</b>			
DRAWING NAME: SG 400 CENTER GLASS 1400 / 1000-1000-970			
DRAWING NUMBER: CD-1203-02			
DRAWN F.C	DATE 04.06.2026	SIZE A4	REV Rev-001
SCALE: 1:1		SHEET: 1 OF 1	

D

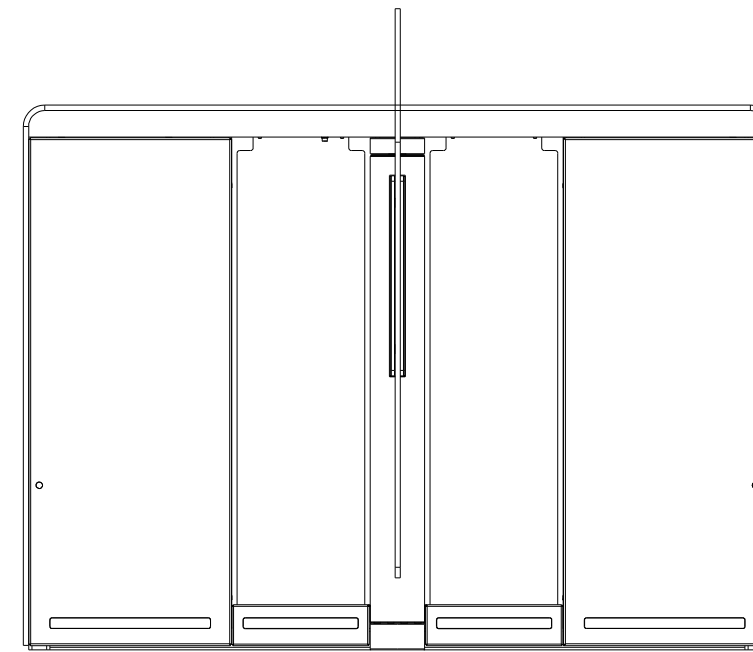
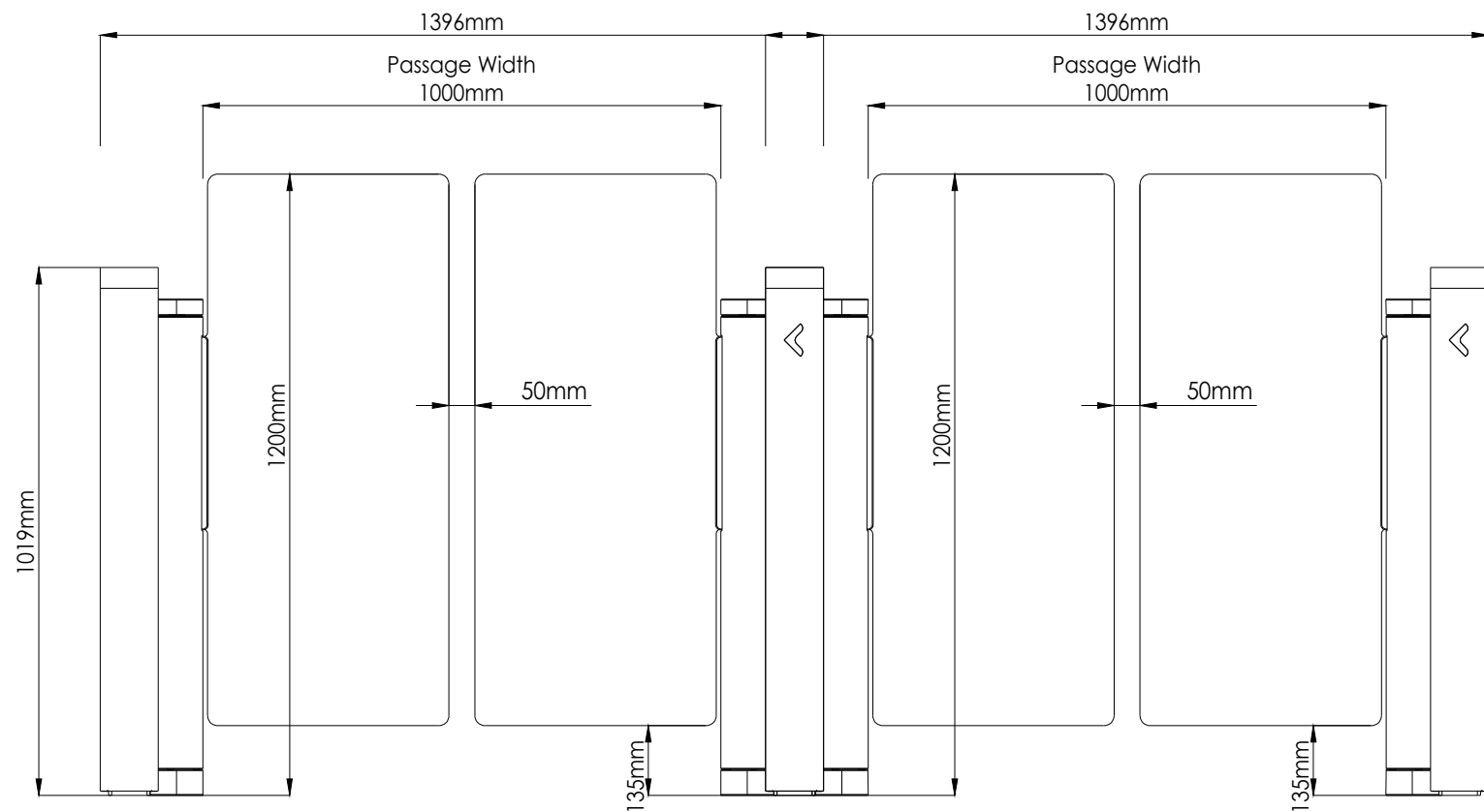

C

B

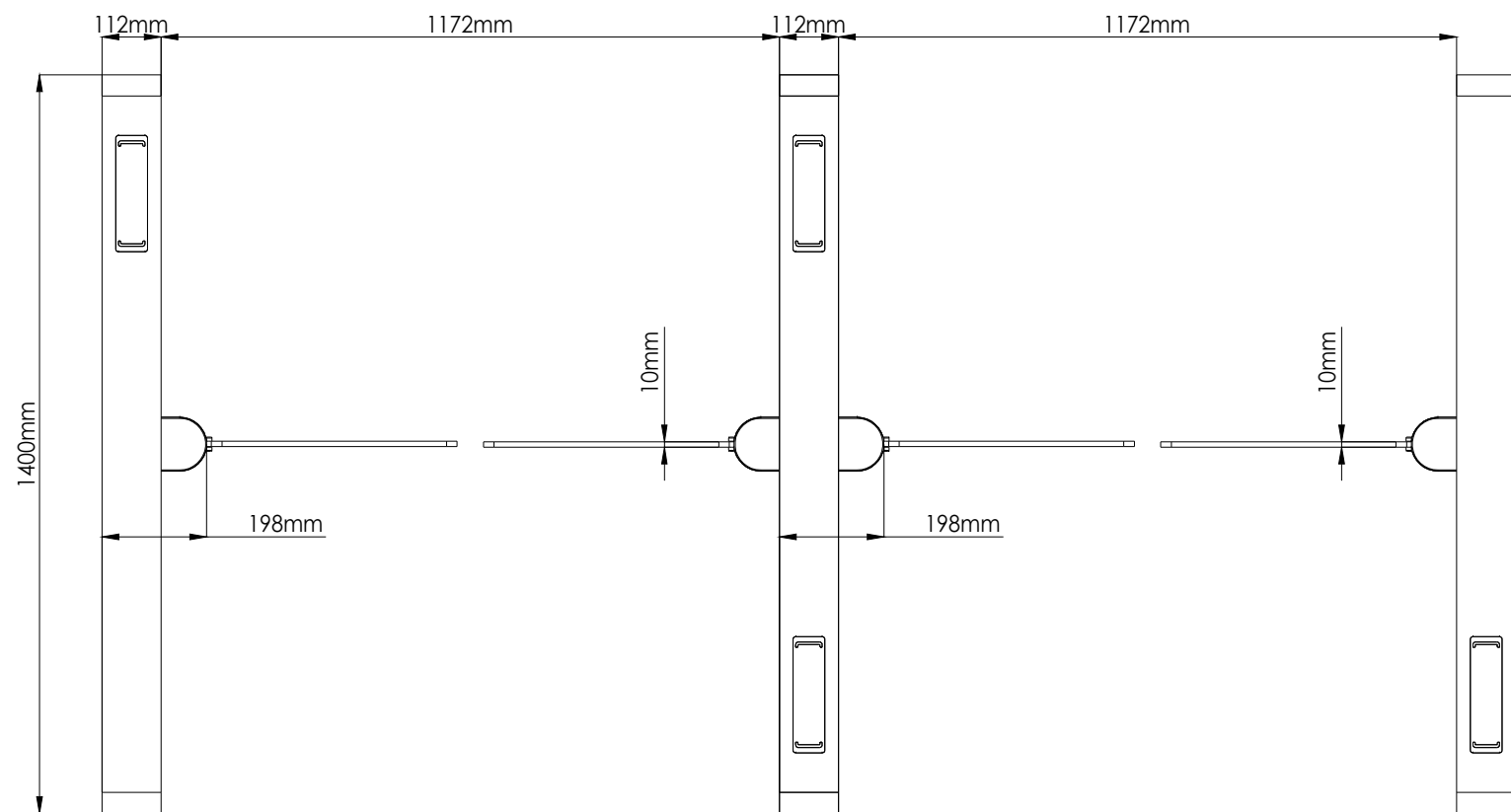

A

<b>ASSA ABLOY</b>			
DRAWING NAME: SG 400 CENTER GLASS 1400 / 1000-1000-1200			
DRAWING NUMBER: CD-1204-02			
DRAWN F.C	DATE 04.06.2026	SIZE A4	REV Rev-001
SCALE: 1:1		SHEET: 1 OF 1	

4

3

2

1

D

C

B

A

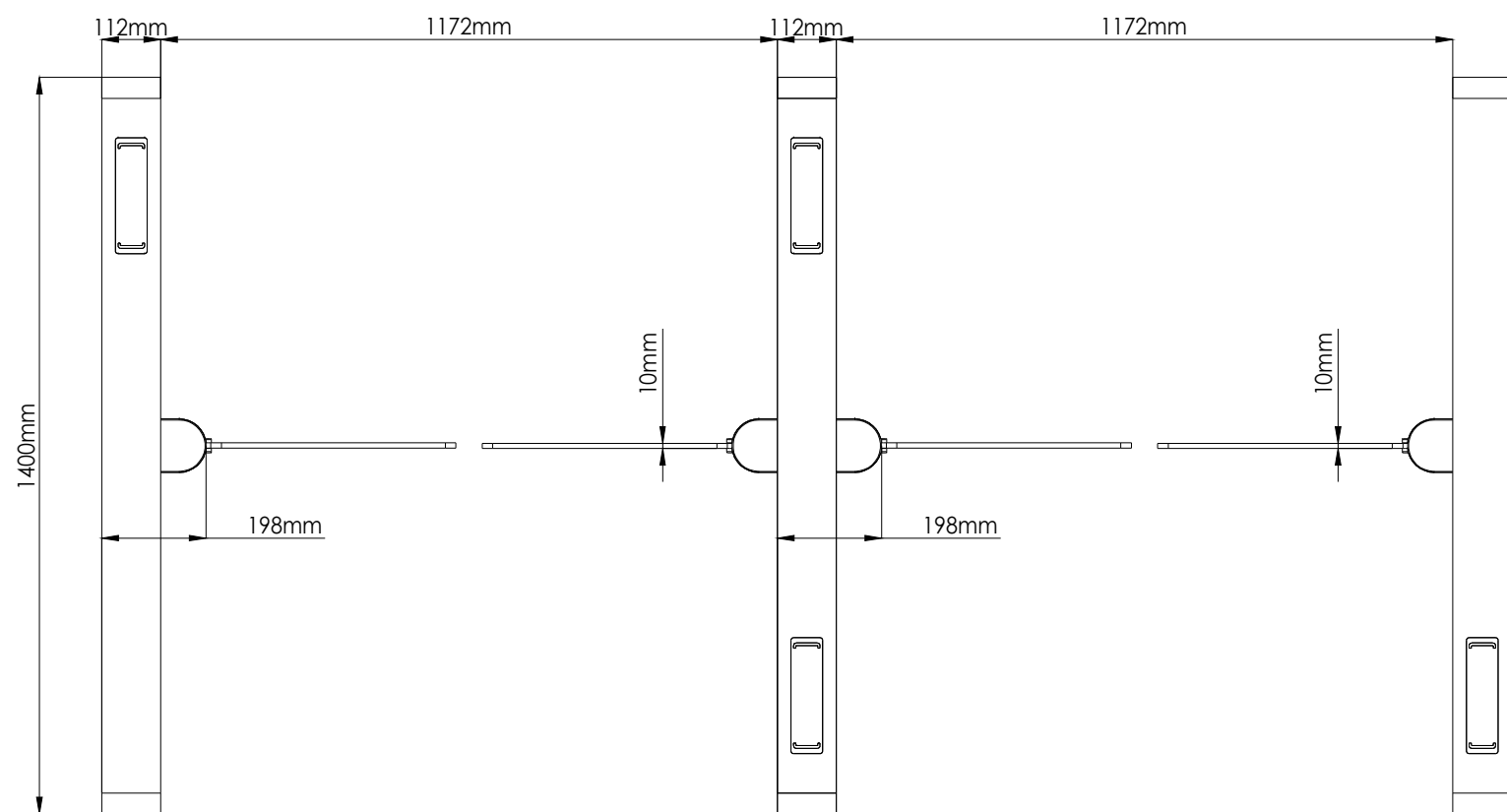
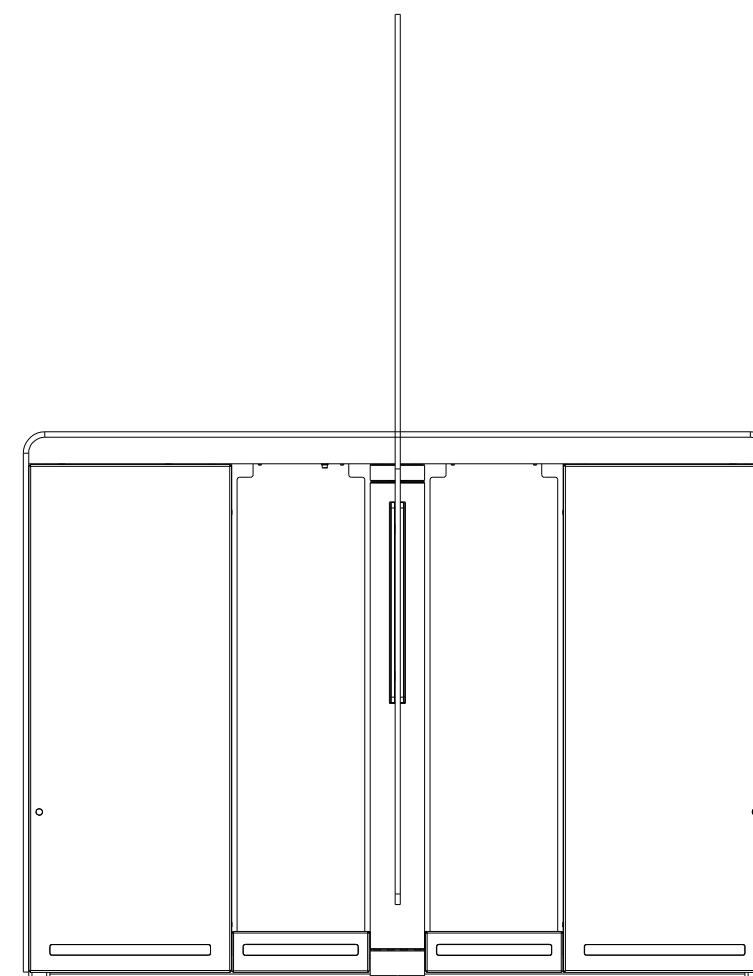
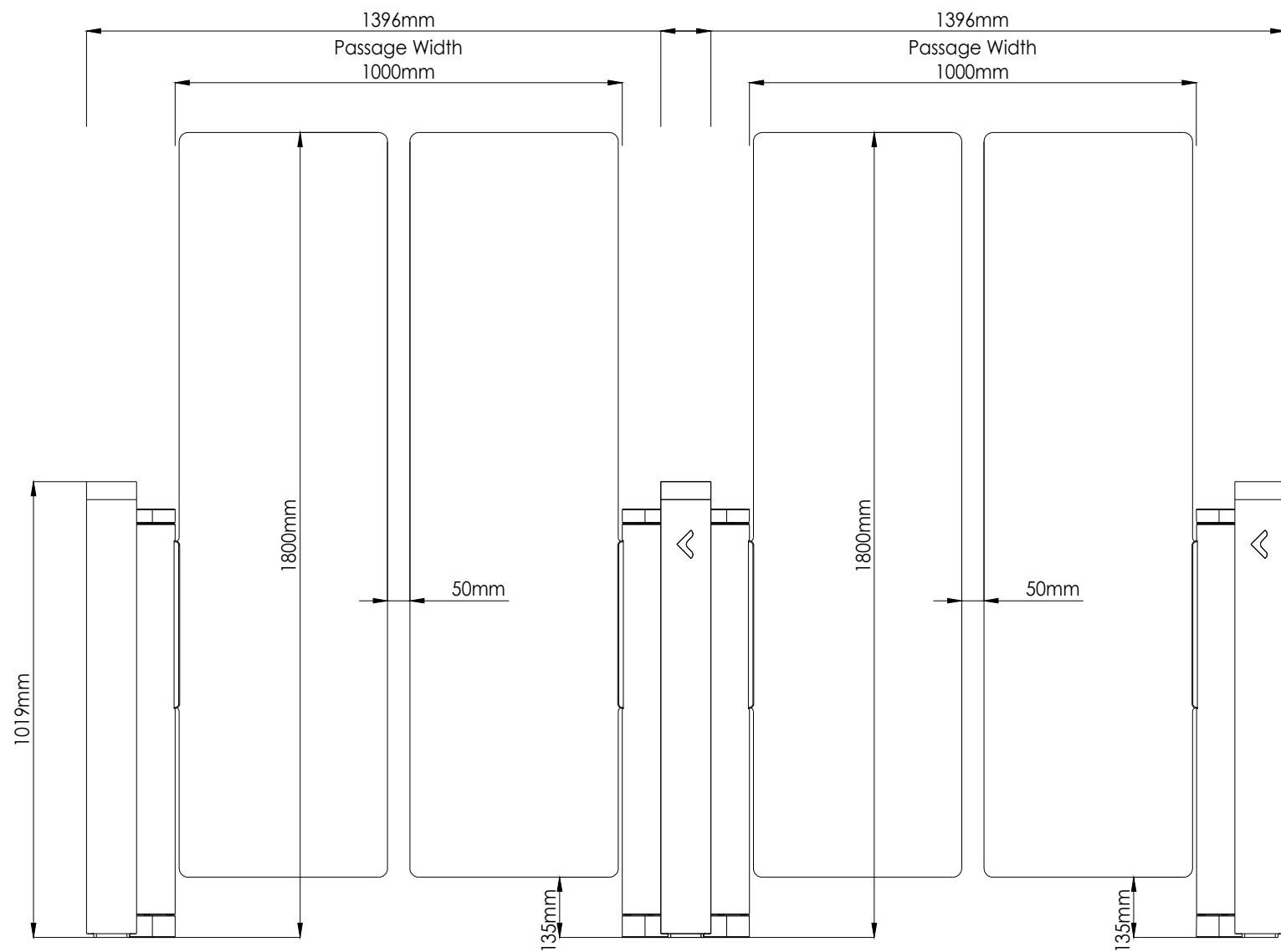

**ASSA ABLOY**

DRAWING NAME:

SG 400 CENTER GLASS 1400 / 1000-1000-1800

DRAWING NUMBER:

CD-1205-02

DRAWN	DATE	SIZE	REV
F.C	04.06.2026	A4	Rev-001

SCALE: 1:1

SHEET: 1 OF 1

D

C

B

A

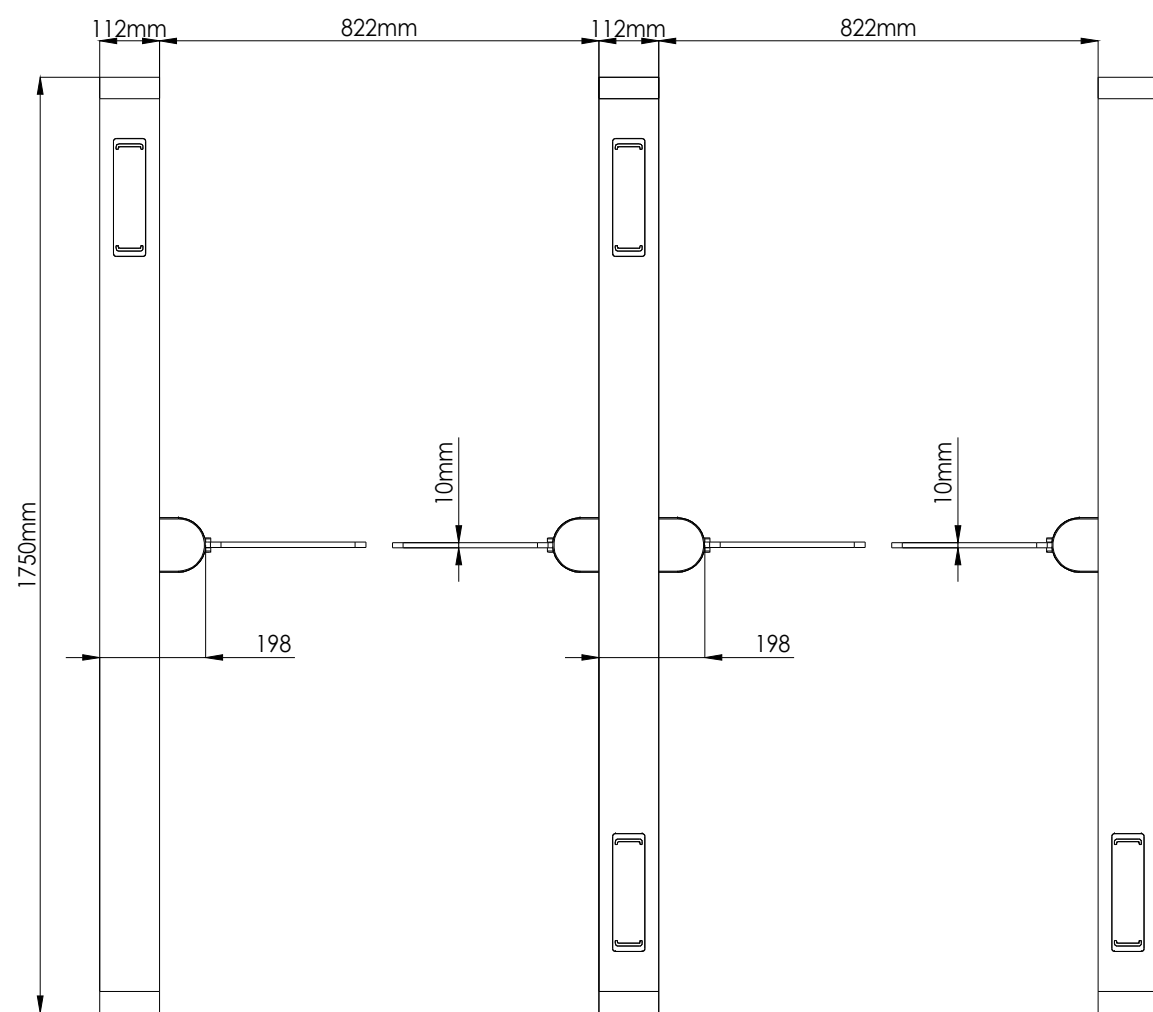
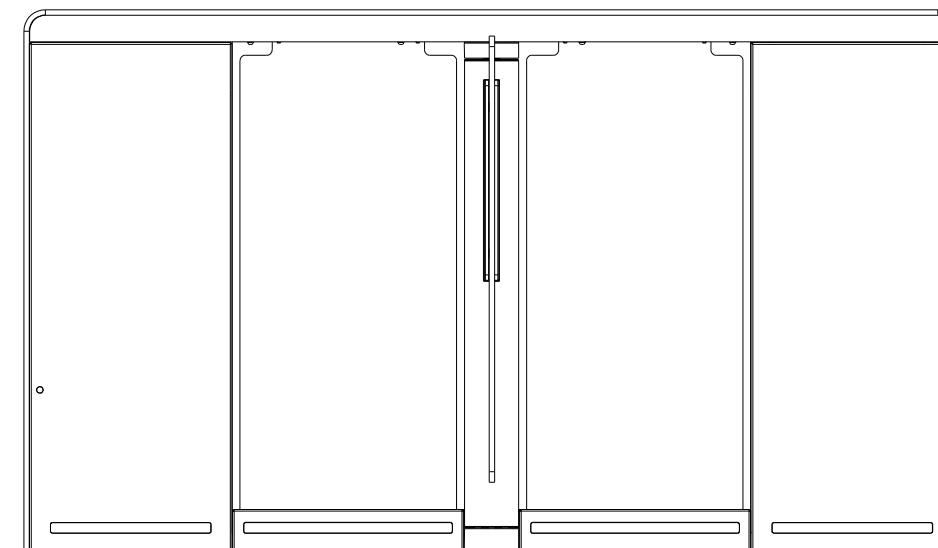
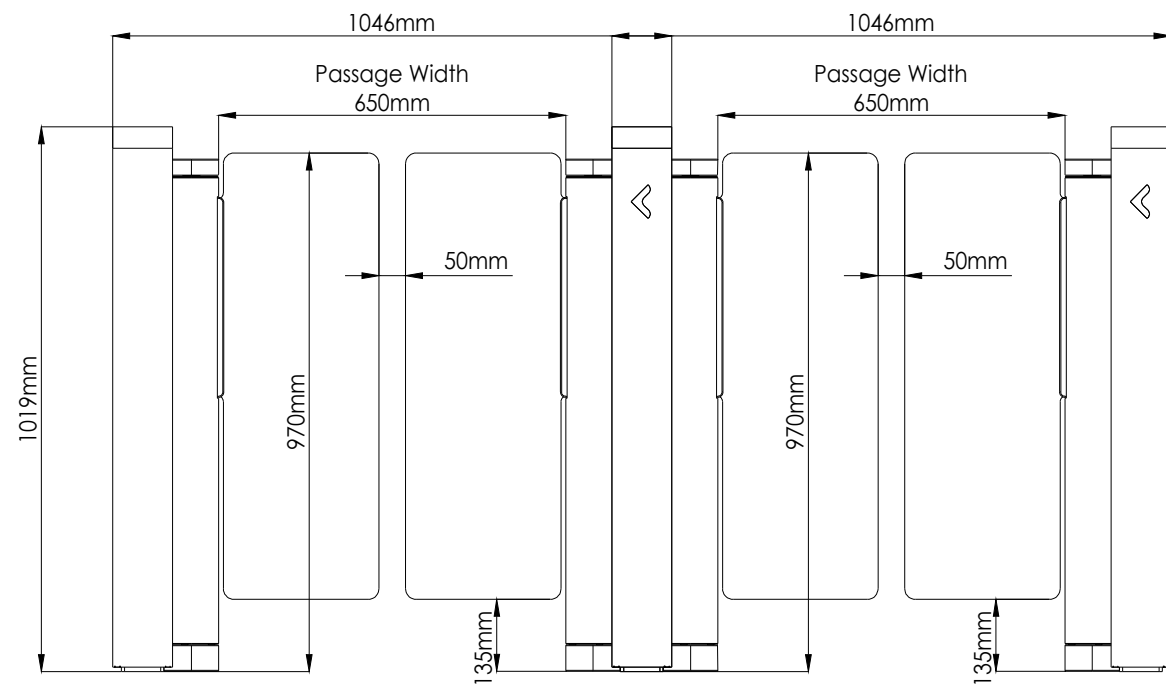

# ASSA ABLOY

DRAWING NAME:  
SG 400 CENTER GLASS 1750 / 650-650-970

DRAWING NUMBER:  
CD-1206-02

DRAWN	DATE	SIZE	REV
F.C	04.06.2026	A4	Rev-001

SCALE: 1:1

SHEET: 1 OF 1

4

3

2

1

D

C

B

A

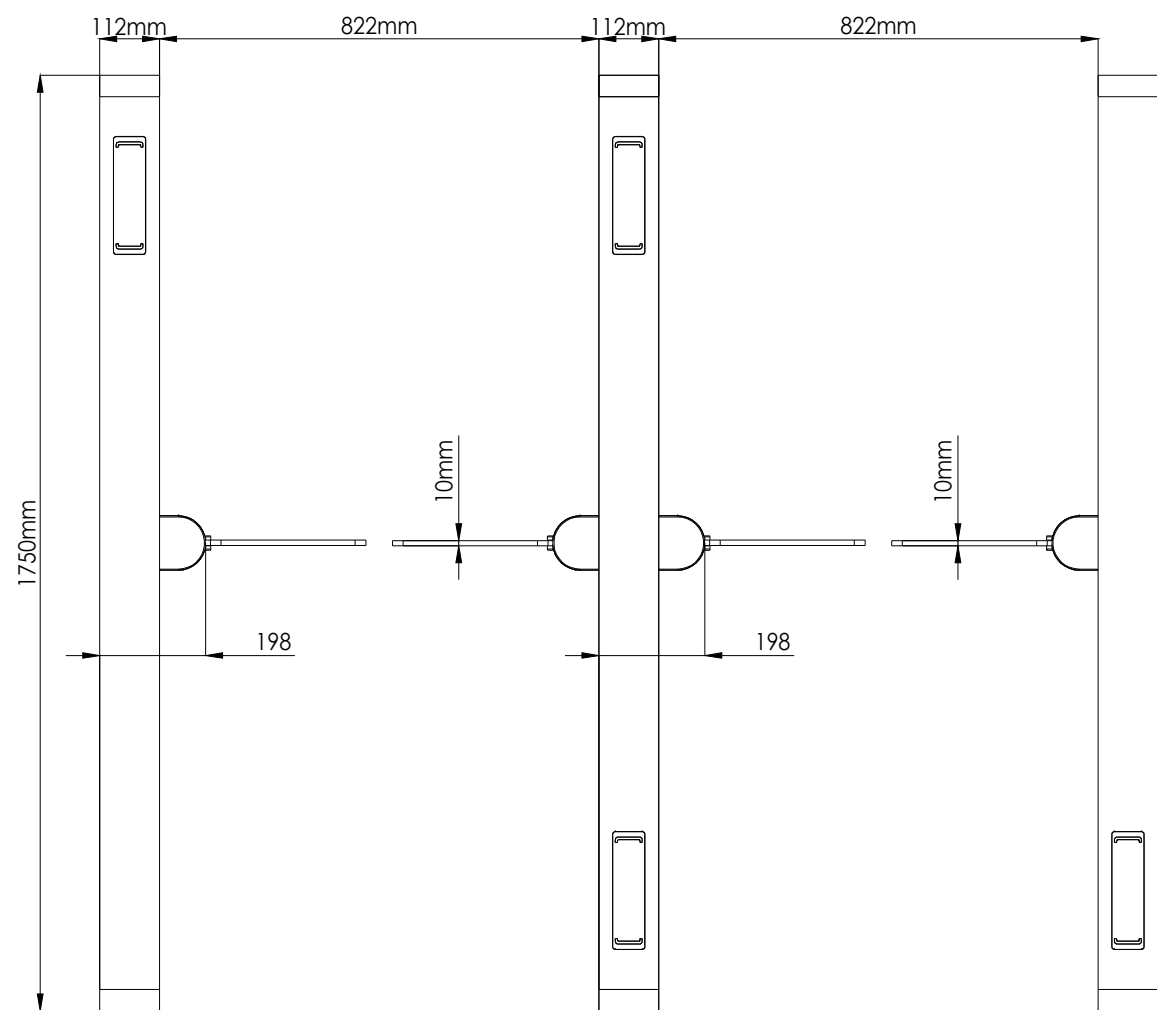
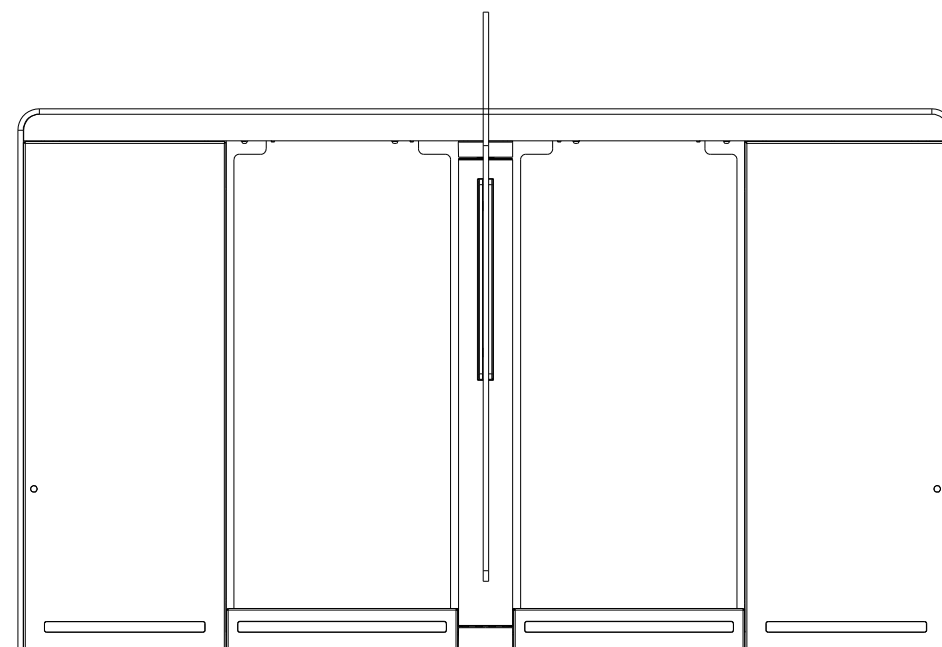
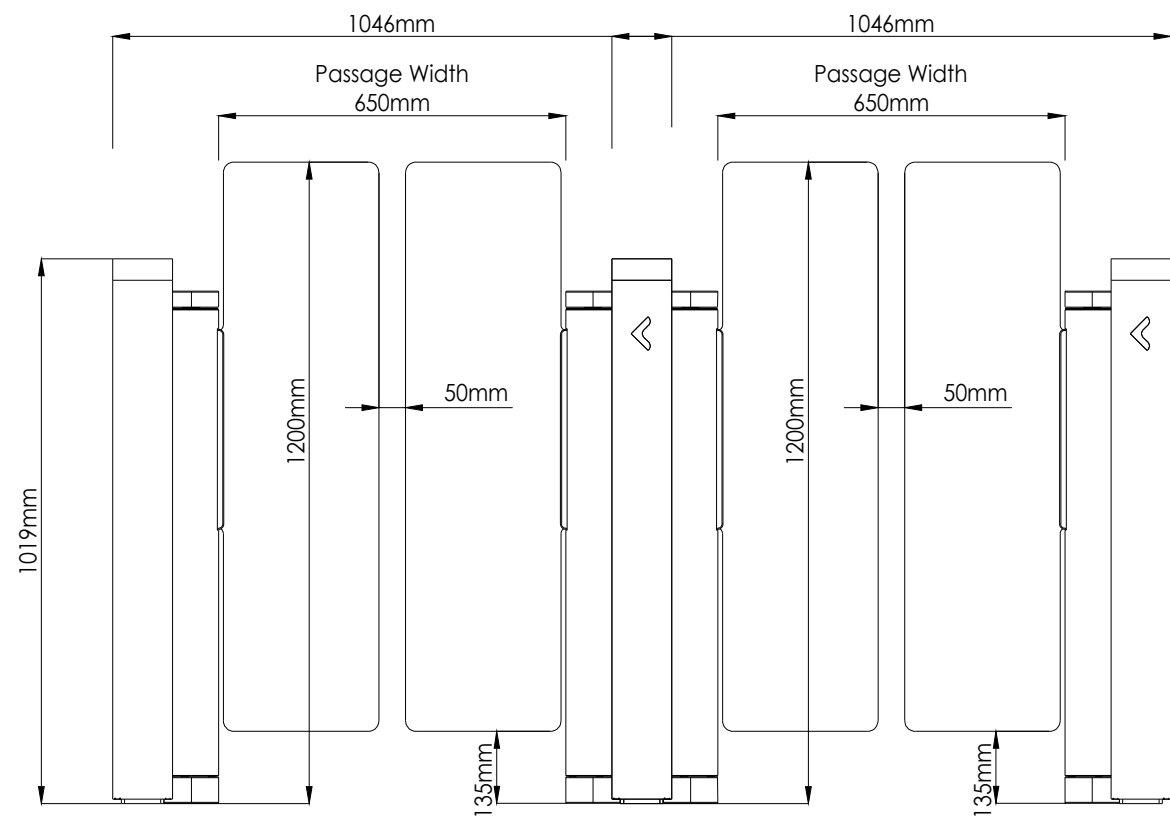

**ASSA ABLOY**

DRAWING NAME:  
SG 400 CENTER GLASS 1750 / 650-650-1200

DRAWING NUMBER:  
CD-1207-02

DRAWN	DATE	SIZE	REV
F.C	04.06.2026	A4	Rev-001

SCALE: 1:1 SHEET: 1 OF 1

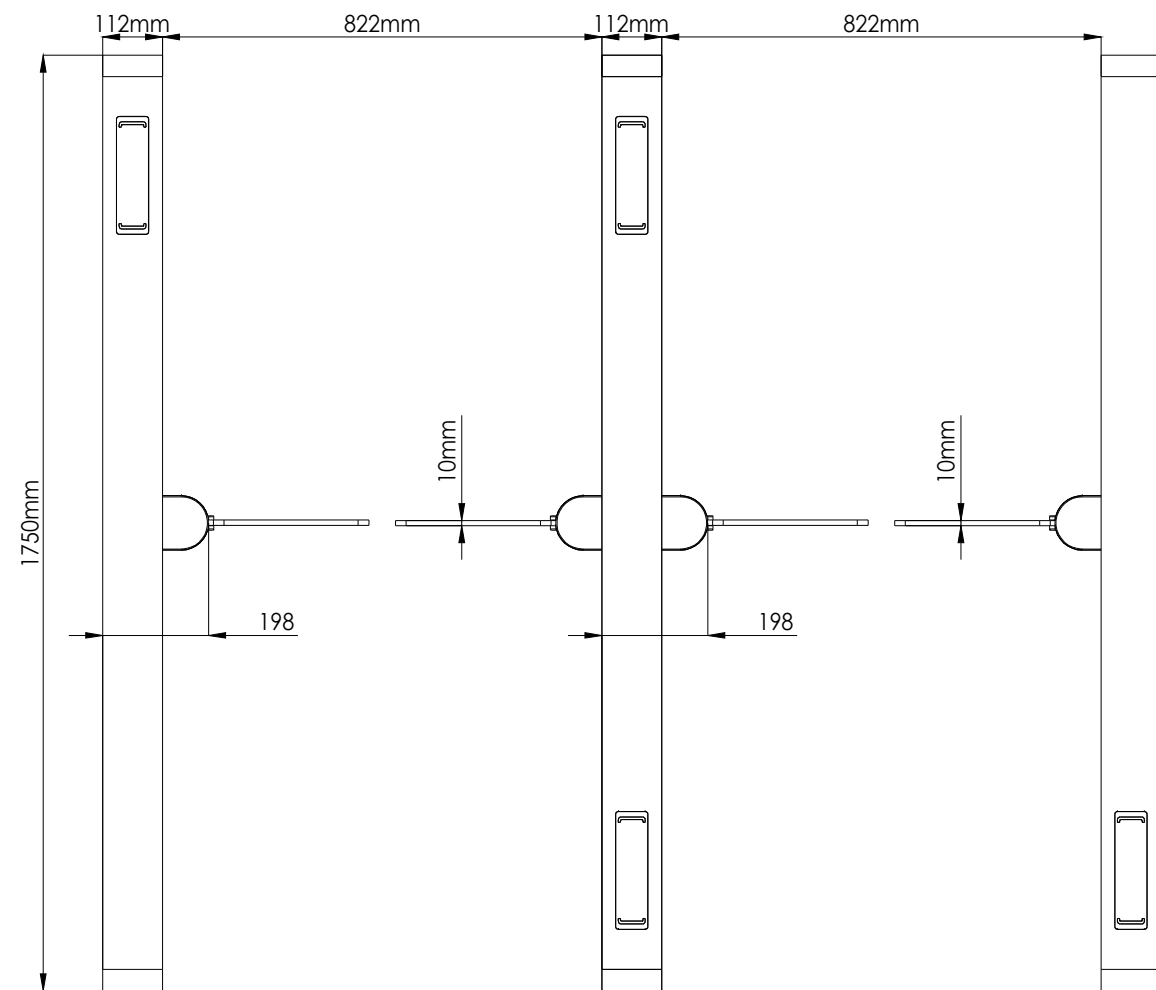
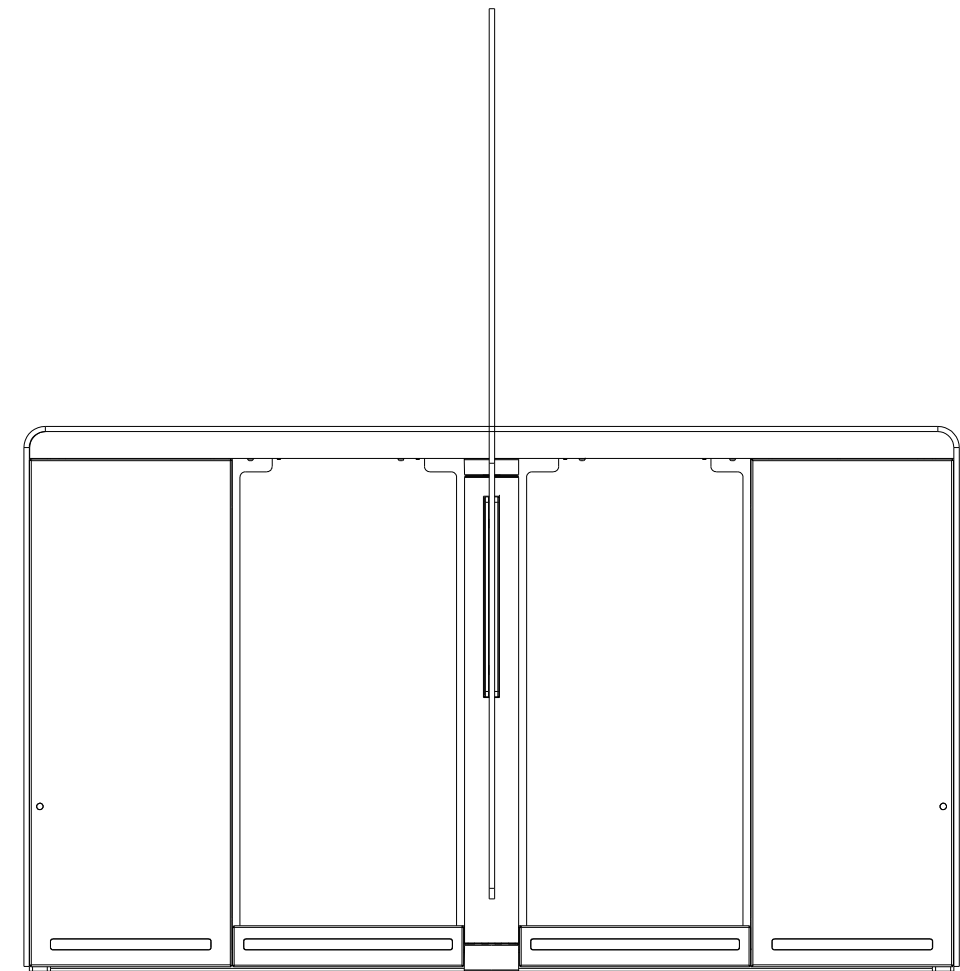
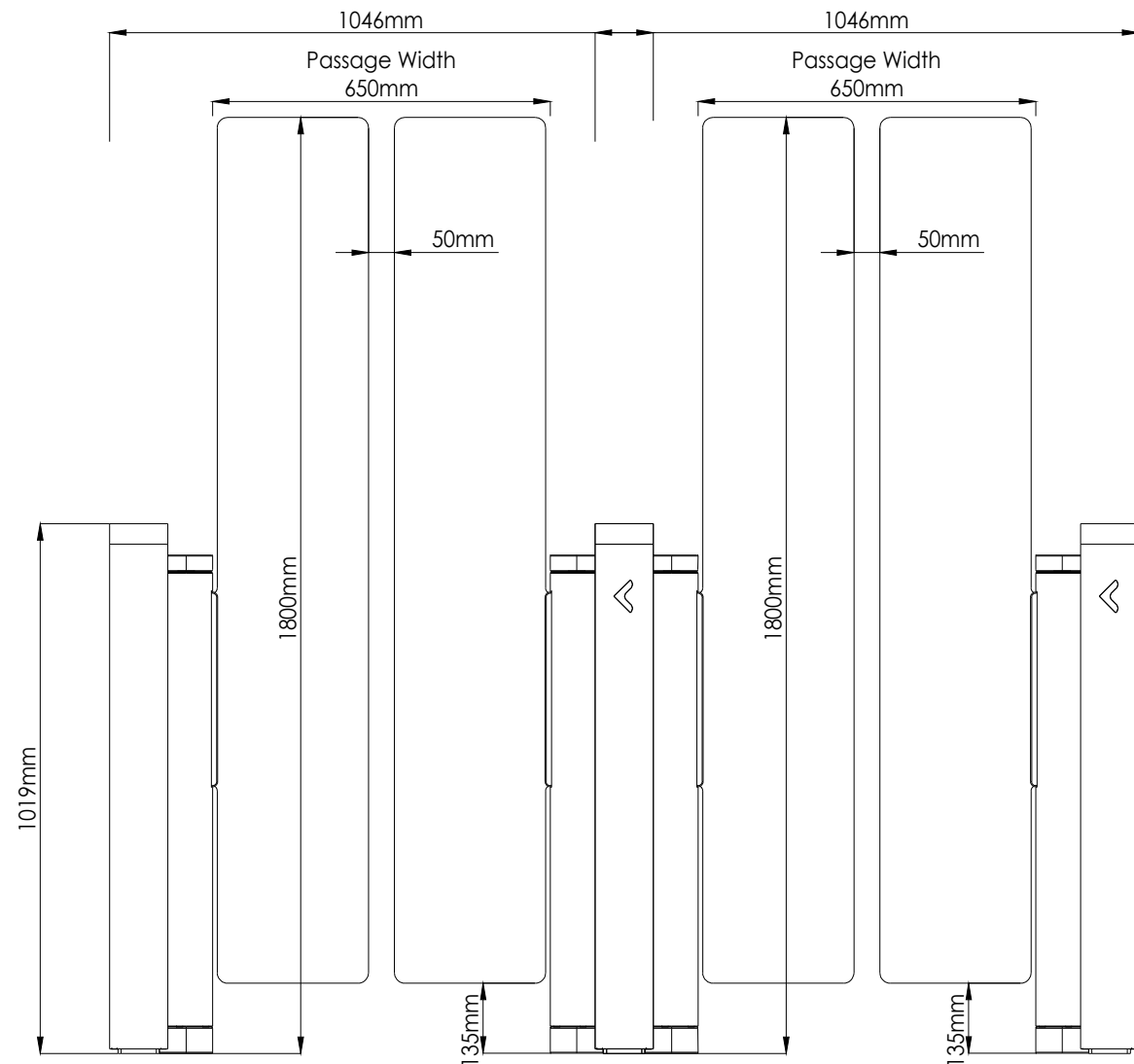

**ASSA ABLOY**

DRAWING NAME:  
SG 400 CENTER GLASS 1750 / 650-650-1800

DRAWING NUMBER:  
CD-1208-02

DRAWN	DATE	SIZE	REV
F.C	04.06.2026	A4	Rev-001

SCALE: 1:1 SHEET: 1 OF 1

4

3

2

1

D

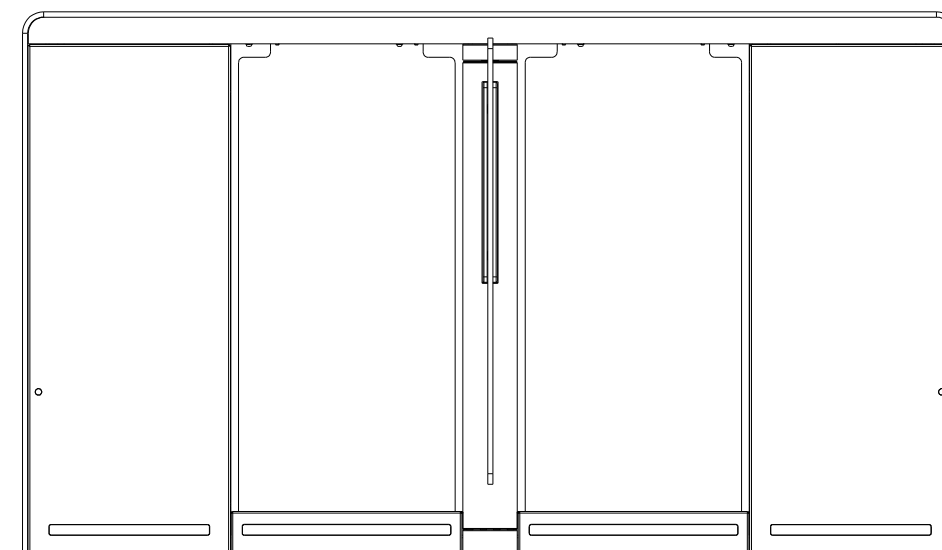
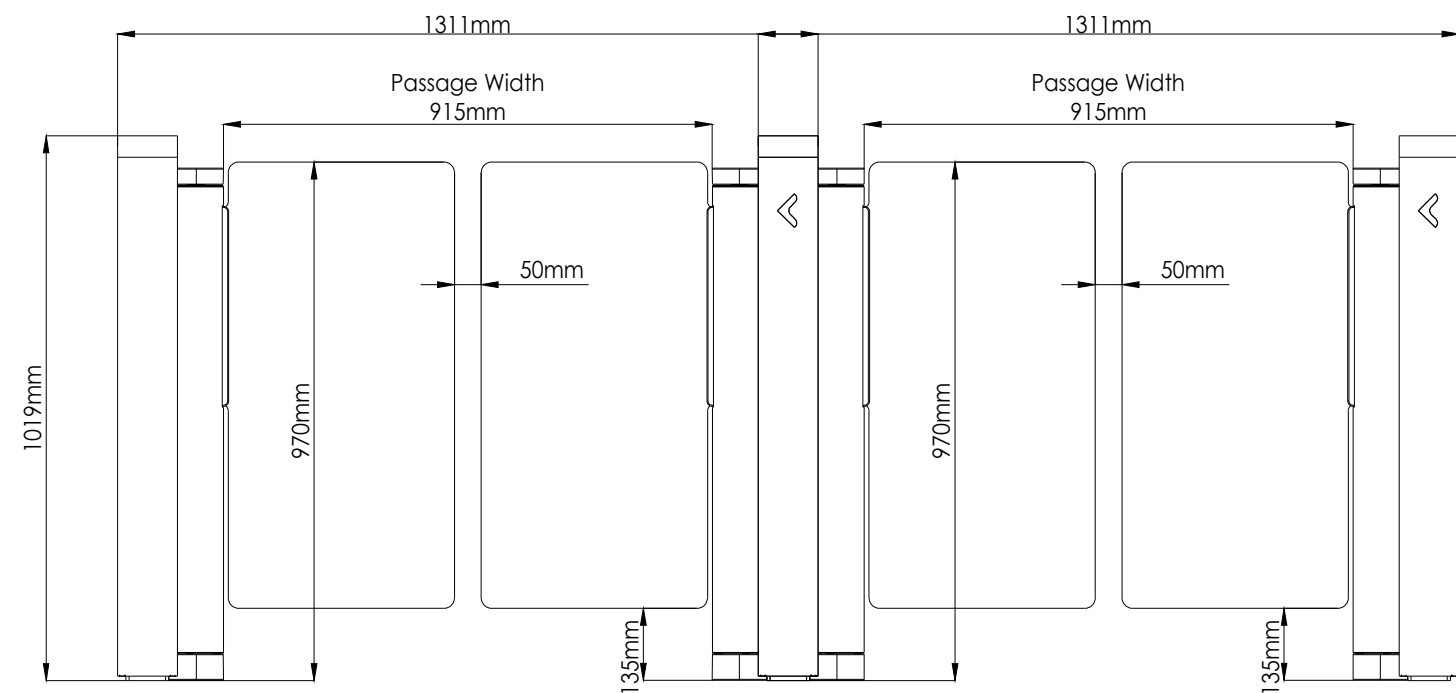

C

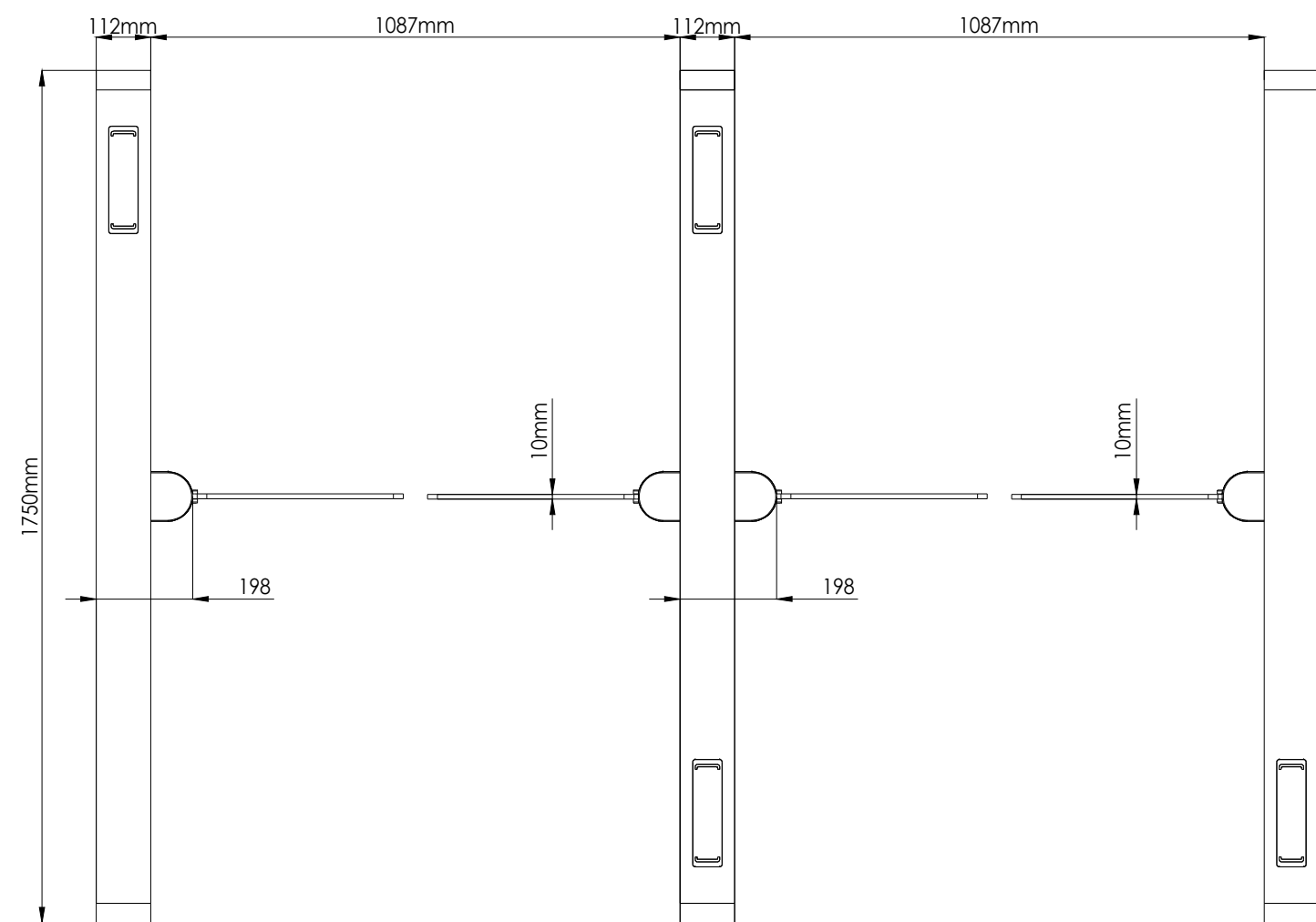

B

A

**ASSA ABLOY**

DRAWING NAME:  
SG 400 CENTER GLASS 1750 / 915-915-970

DRAWING NUMBER:  
CD-1209-02

DRAWN F.C	DATE 04.06.2026	SIZE A4	REV Rev-001
--------------	--------------------	------------	----------------

SCALE: 1:1

SHEET: 1 OF 1

4

3

2

1

D

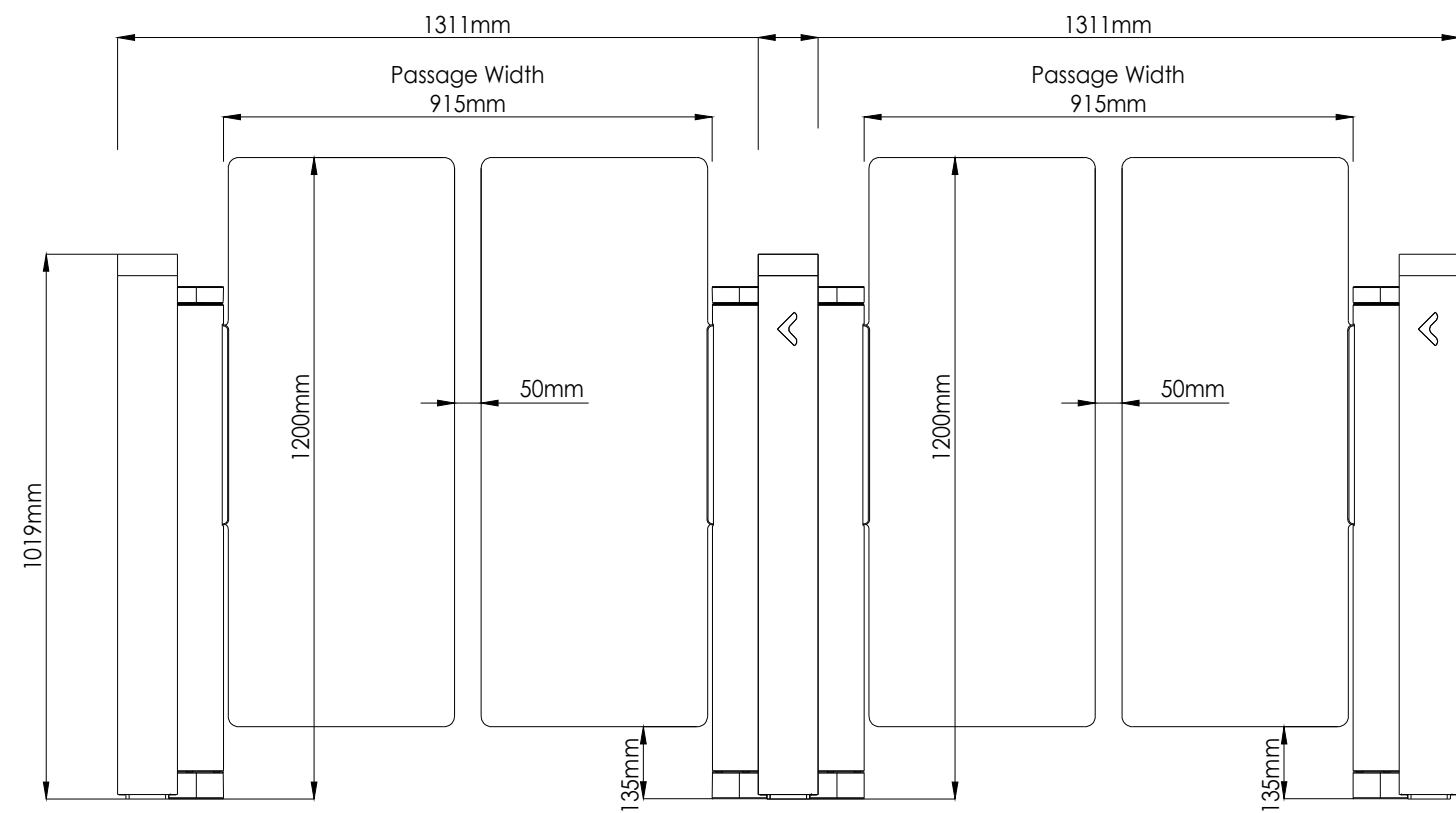

C

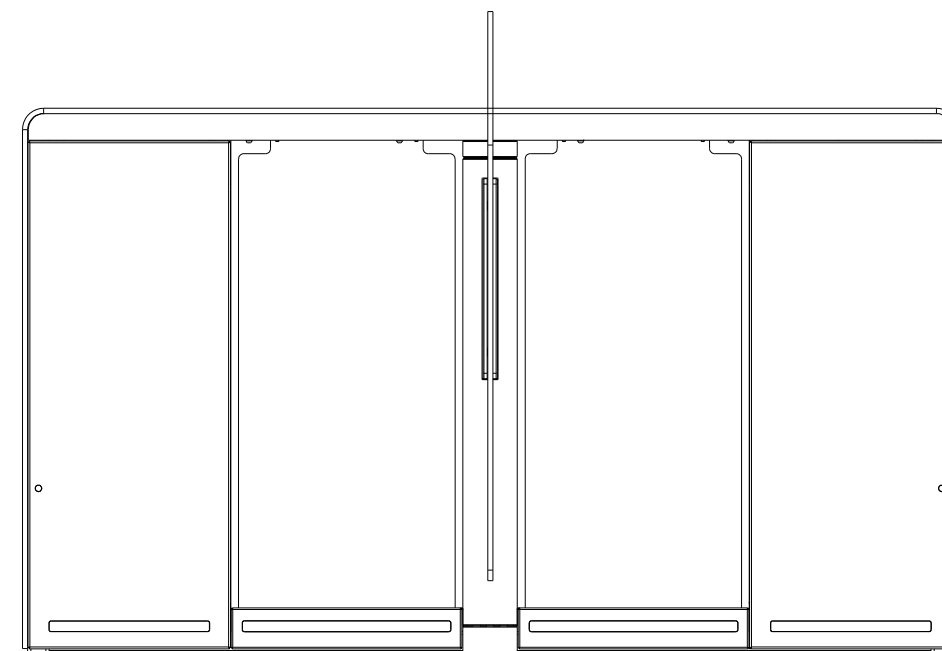

B

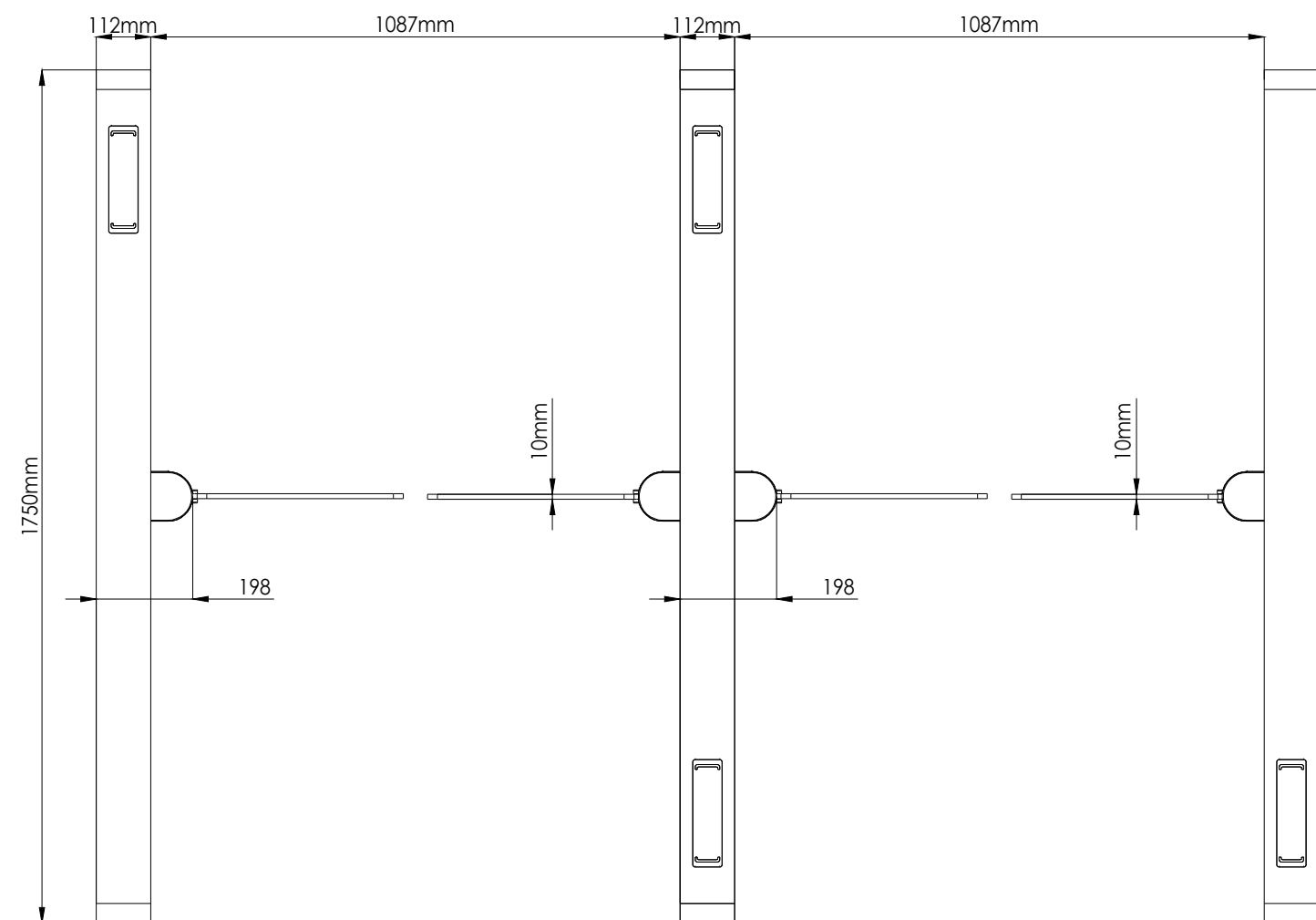

A

<b>ASSA ABLOY</b>			
DRAWING NAME: SG 400 CENTER GLASS 1750 / 915-915-1200			
DRAWING NUMBER: CD-1210-02			
DRAWN F.C	DATE 04.06.2026	SIZE A4	REV Rev-001
SCALE: 1:1		SHEET: 1 OF 1	

4

3

2

1

D

C

B

A

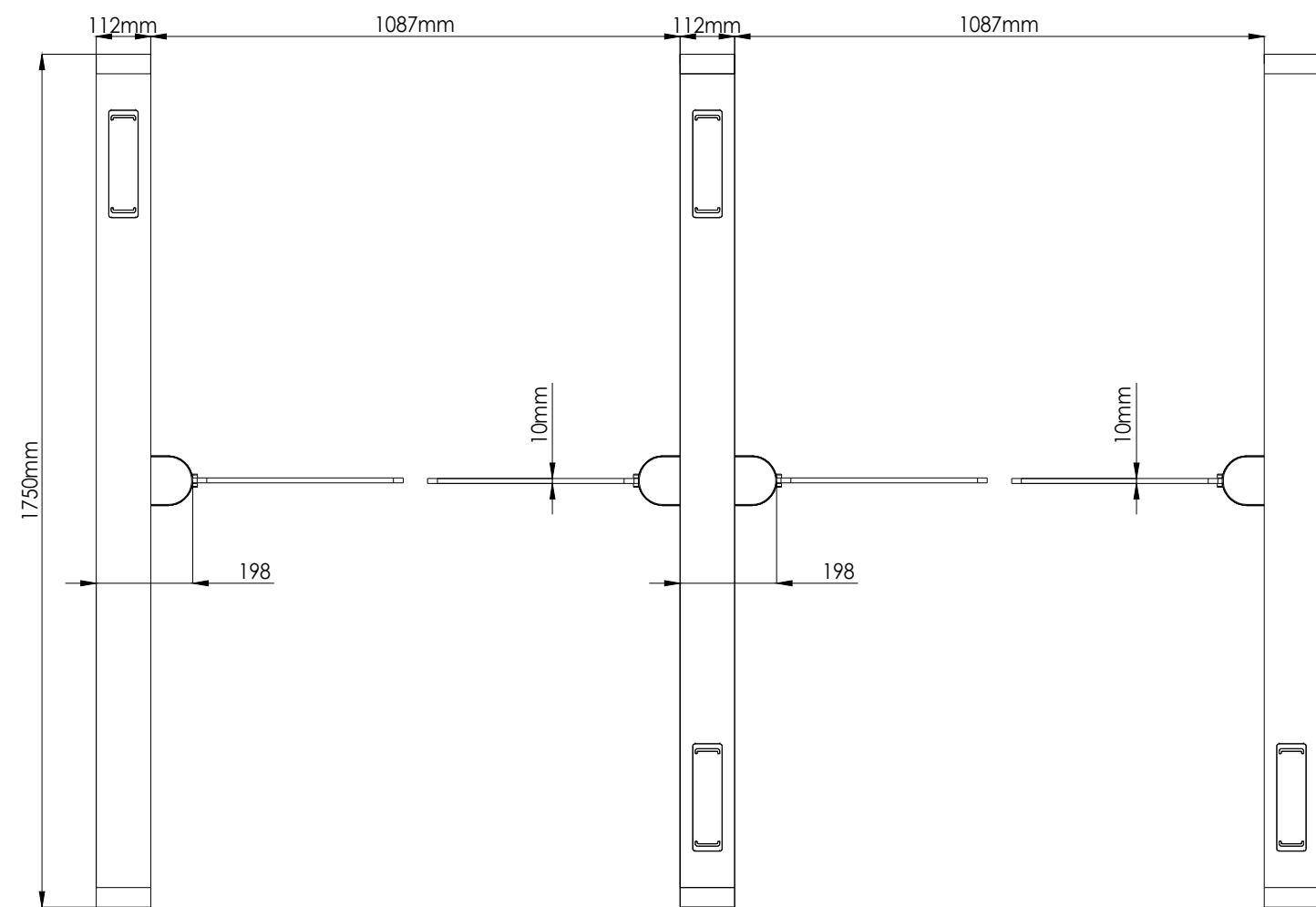
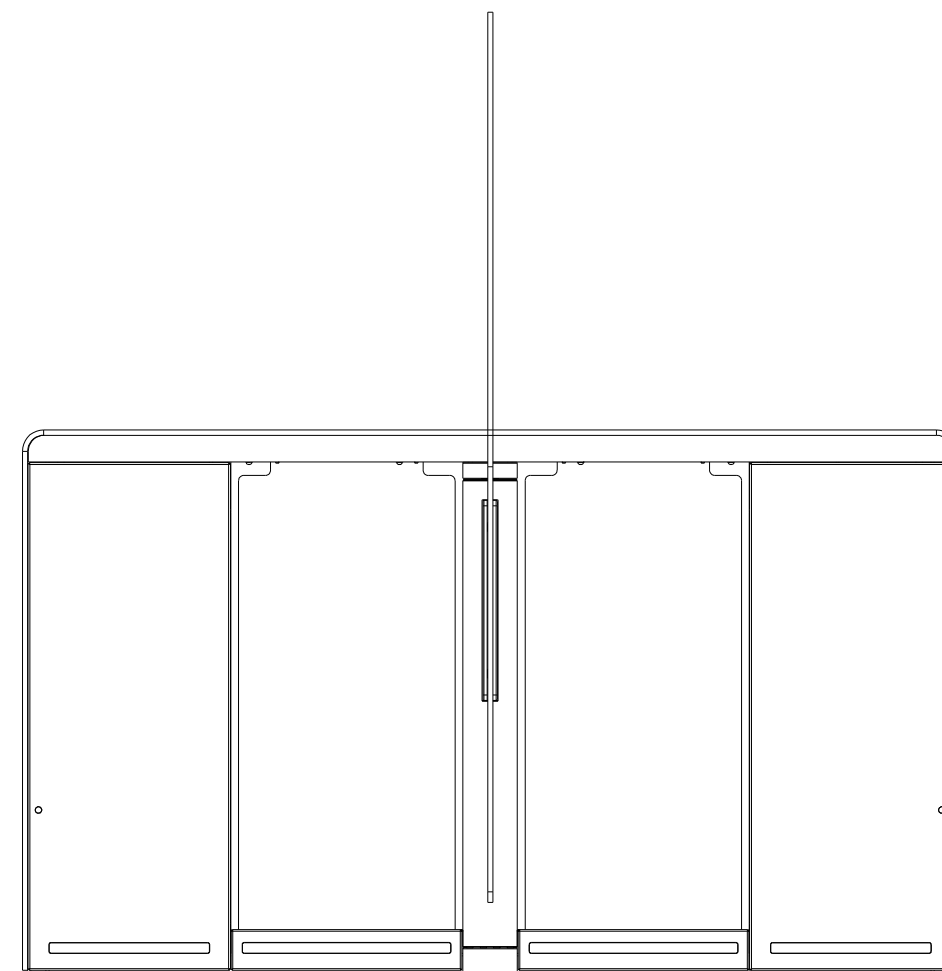
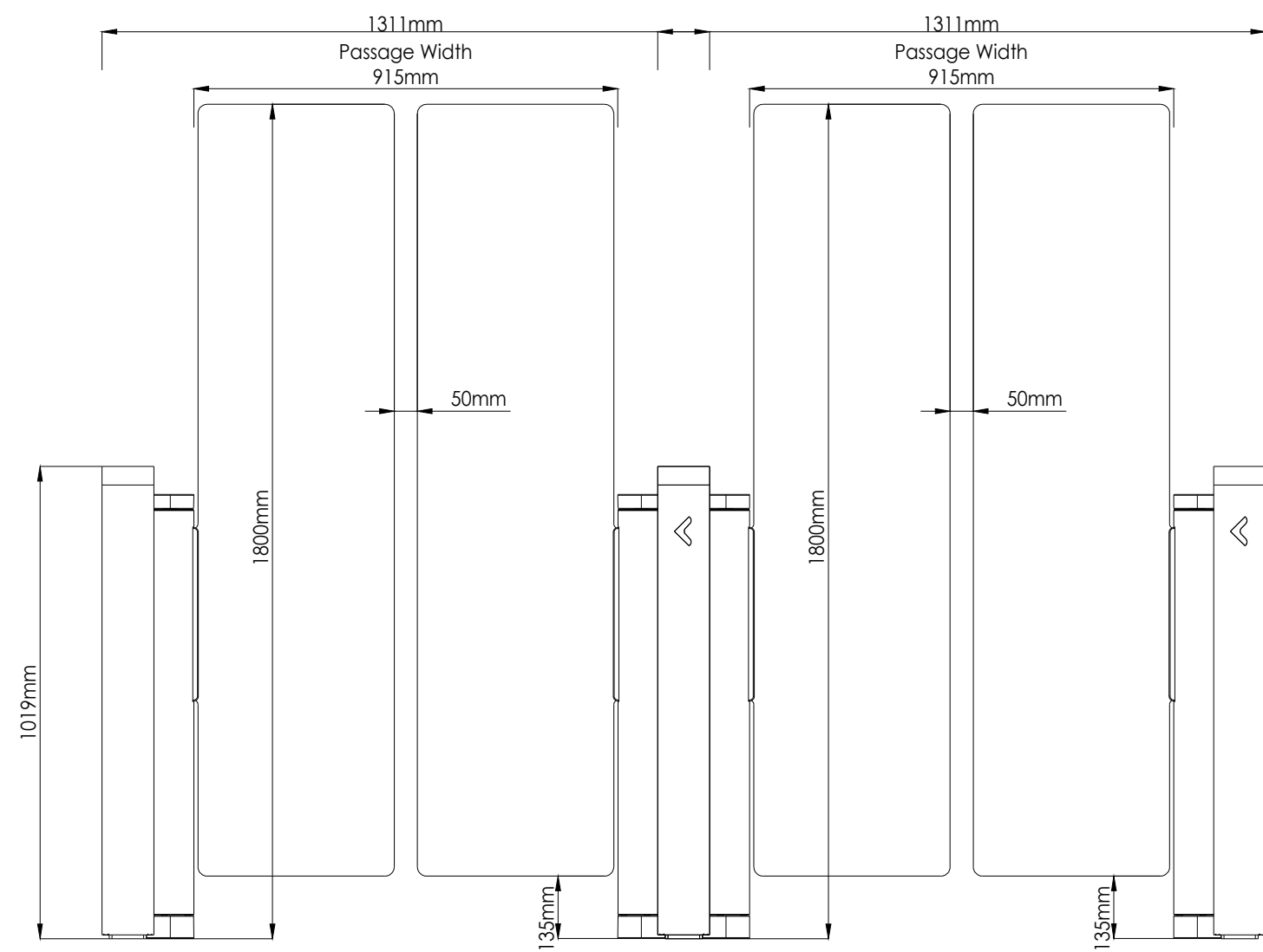

**ASSA ABLOY**

DRAWING NAME:  
SG 400 CENTER GLASS 1750 / 915-915-1800

DRAWING NUMBER:  
CD-1211-02

DRAWN F.C	DATE 04.06.2026	SIZE A4	REV Rev-001
--------------	--------------------	------------	----------------

SCALE: 1:1 SHEET: 1 OF 1

D

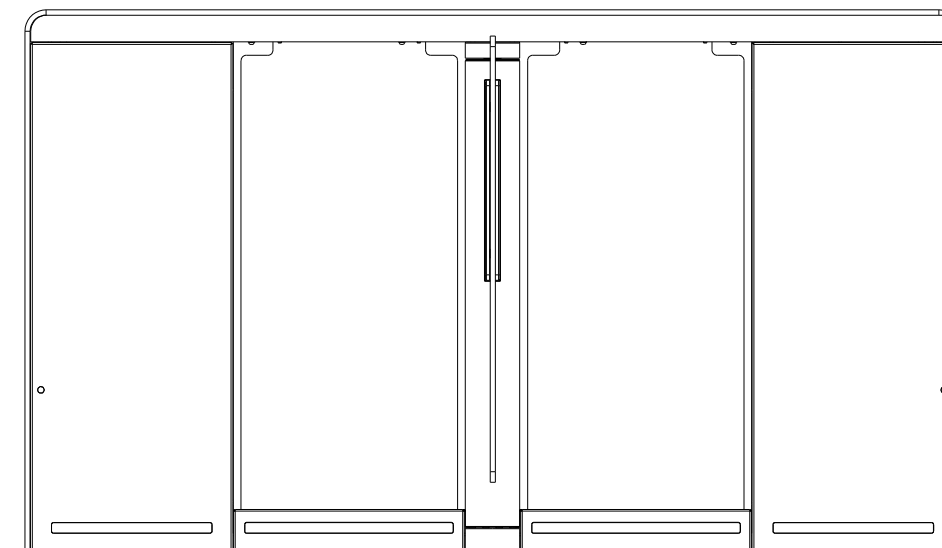
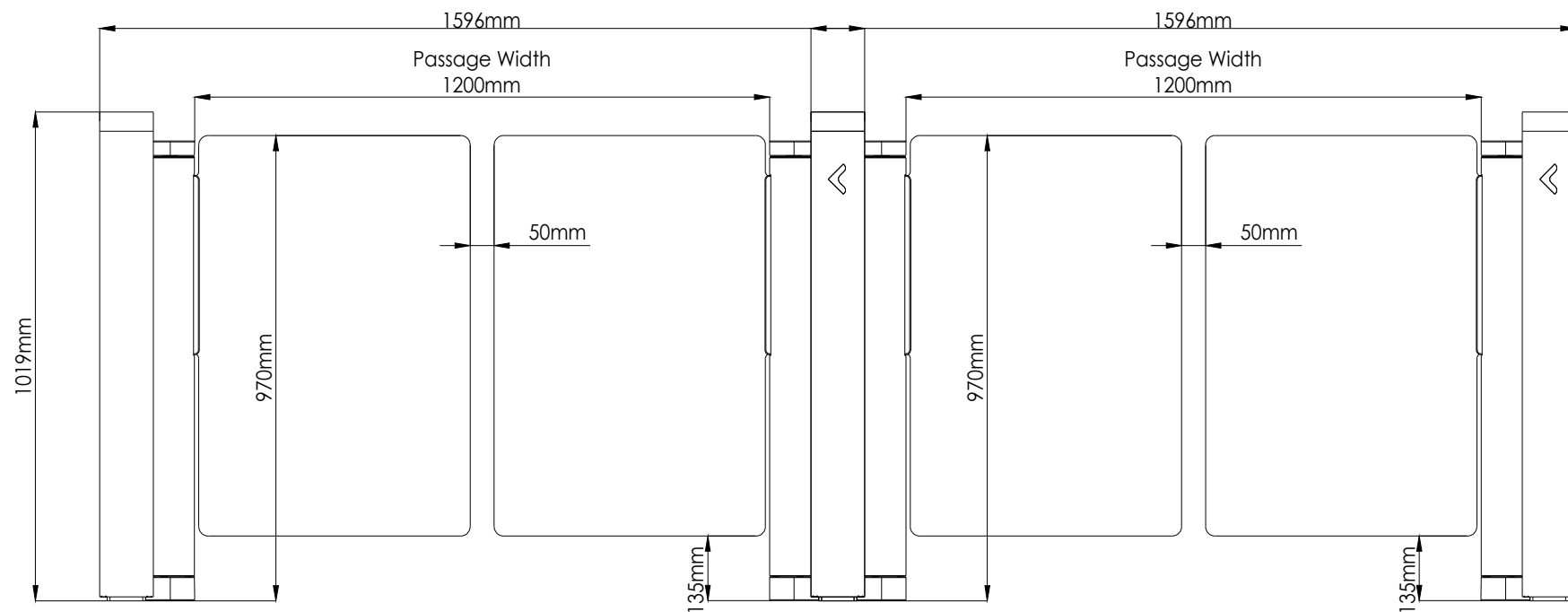

C

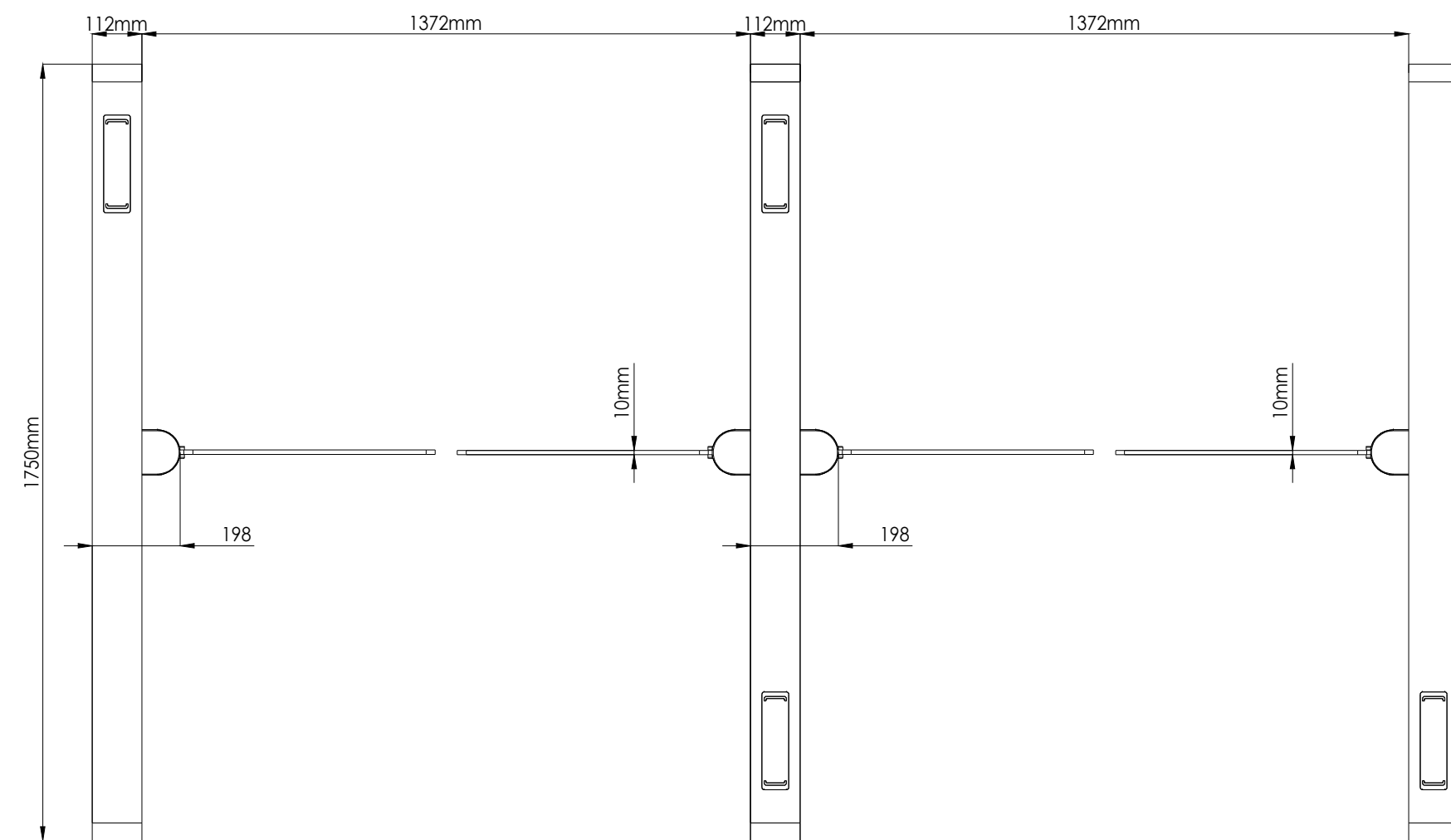

B

A

<b>ASSA ABLOY</b>			
DRAWING NAME: SG 400 CENTER GLASS 1750 / 1200-1200-970			
DRAWING NUMBER: CD-1212-02			
DRAWN F.C	DATE 04.06.2026	SIZE A4	REV Rev-001
SCALE: 1:1		SHEET: 1 OF 1	

4

3

2

1

D

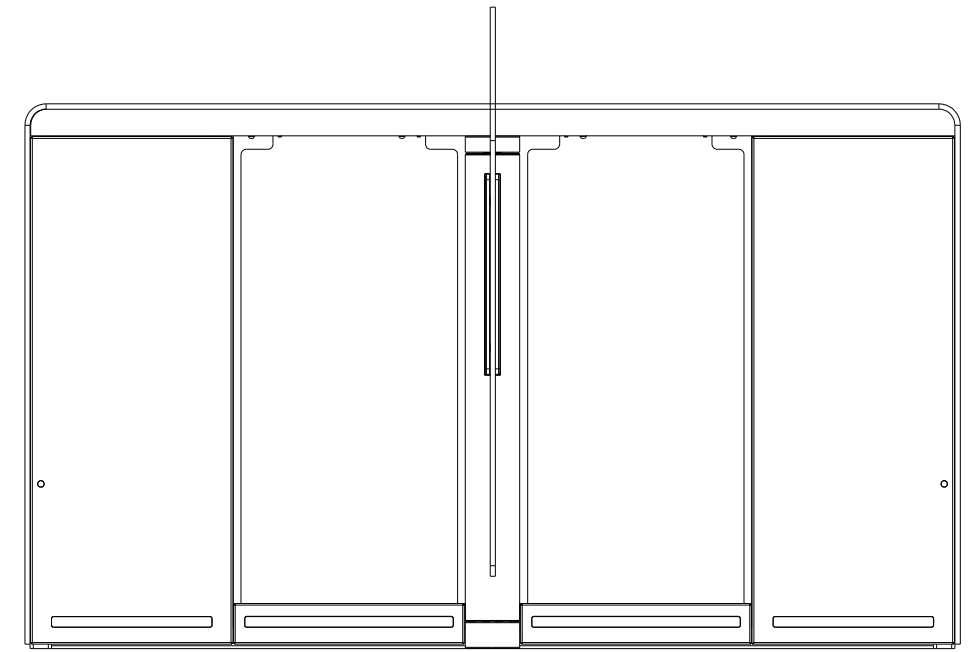
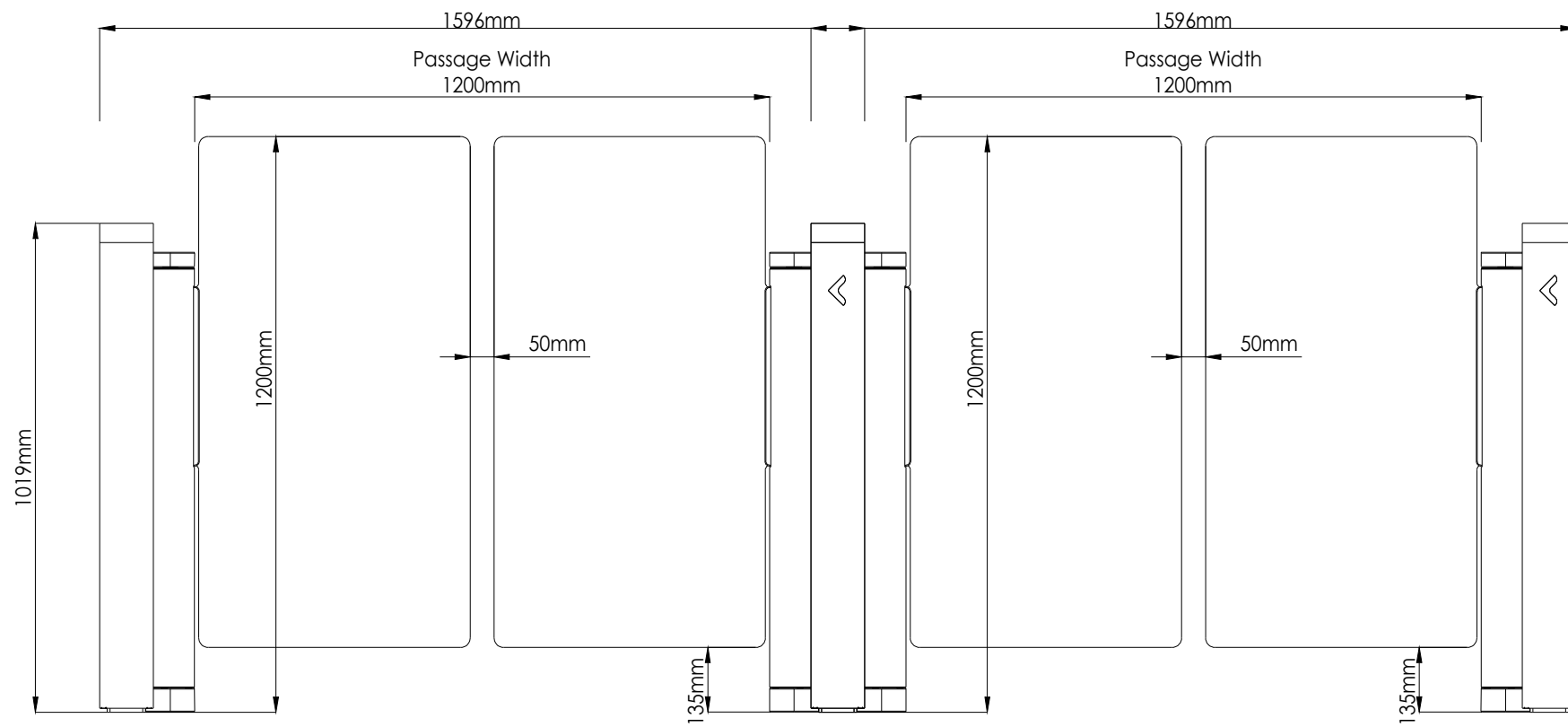

C

B

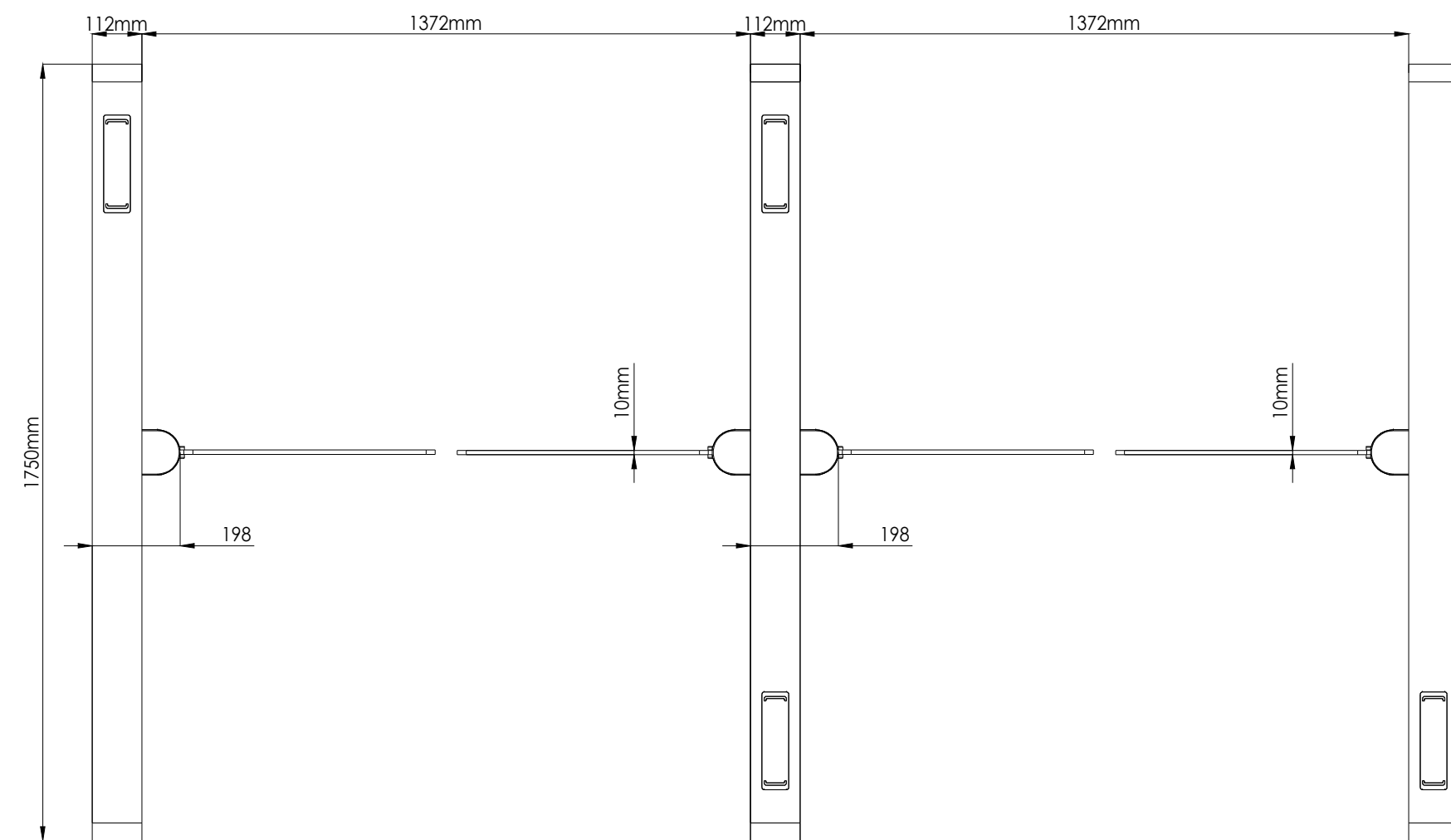

A

**ASSA ABLOY**

DRAWING NAME:  
SG 400 1750 / 1200-1200-1200

DRAWING NUMBER:  
CD-1213-02

DRAWN F.C	DATE 04.06.2026	SIZE A4	REV Rev-001
--------------	--------------------	------------	----------------

SCALE: 1:1 SHEET: 1 OF 1

4

3

2

1

D

C

B

A

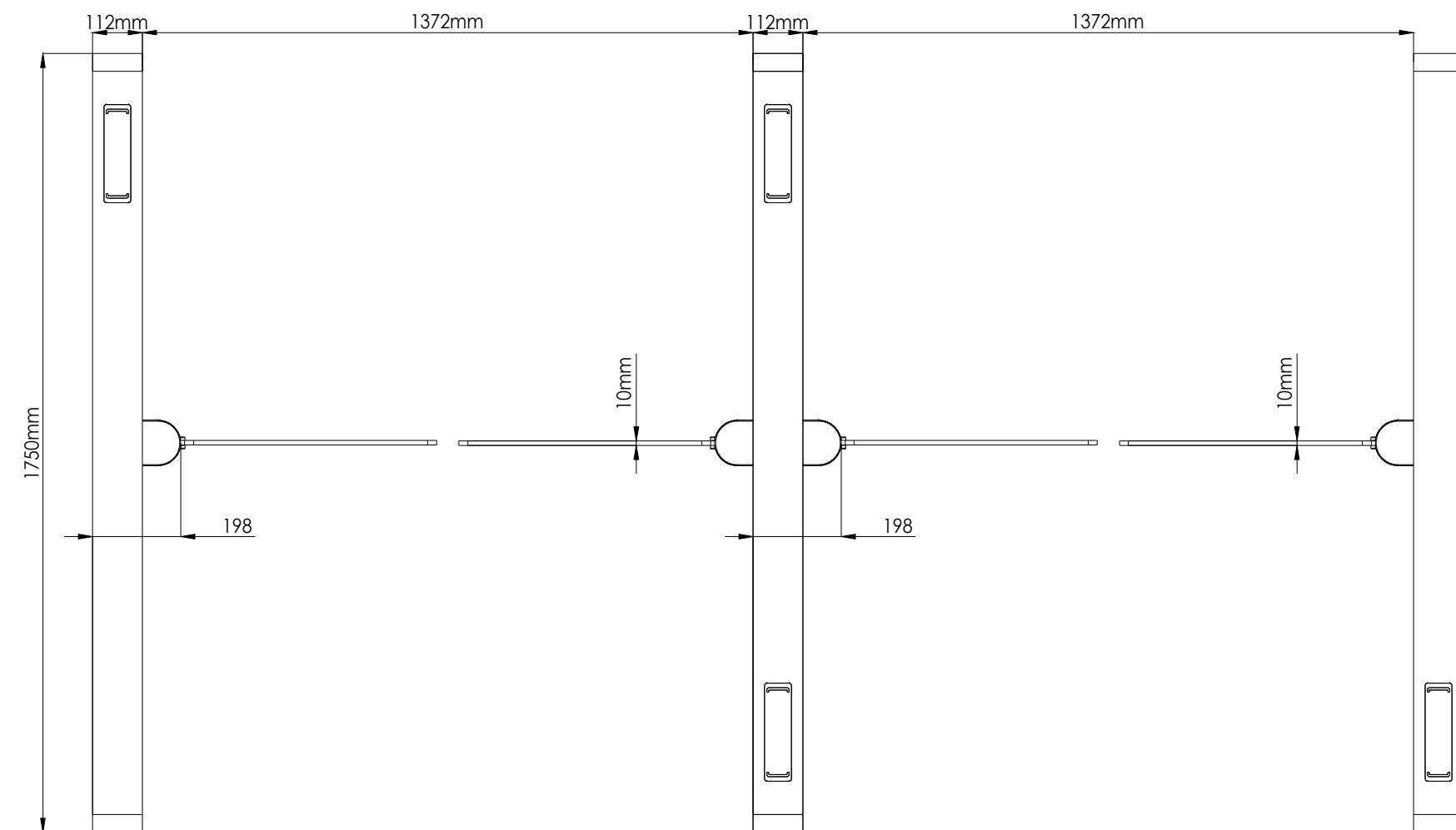
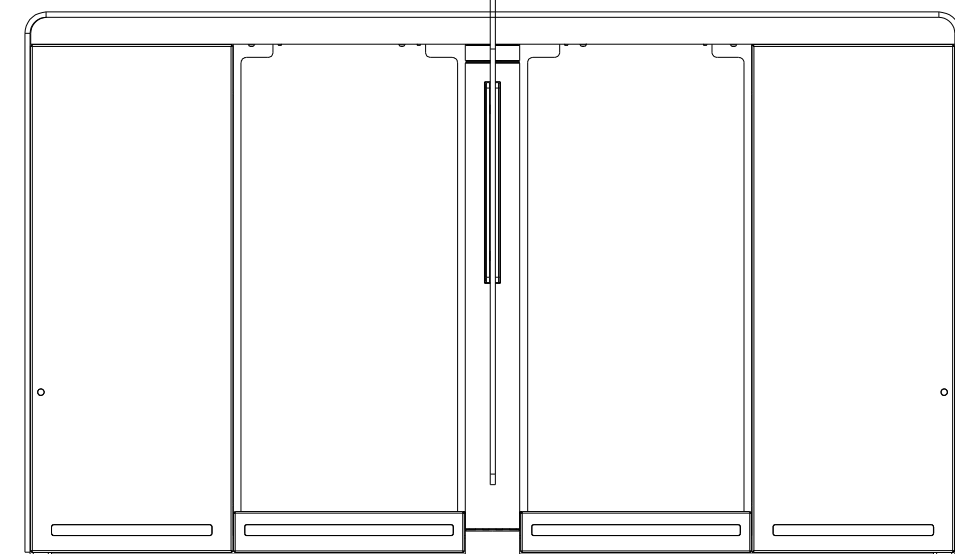
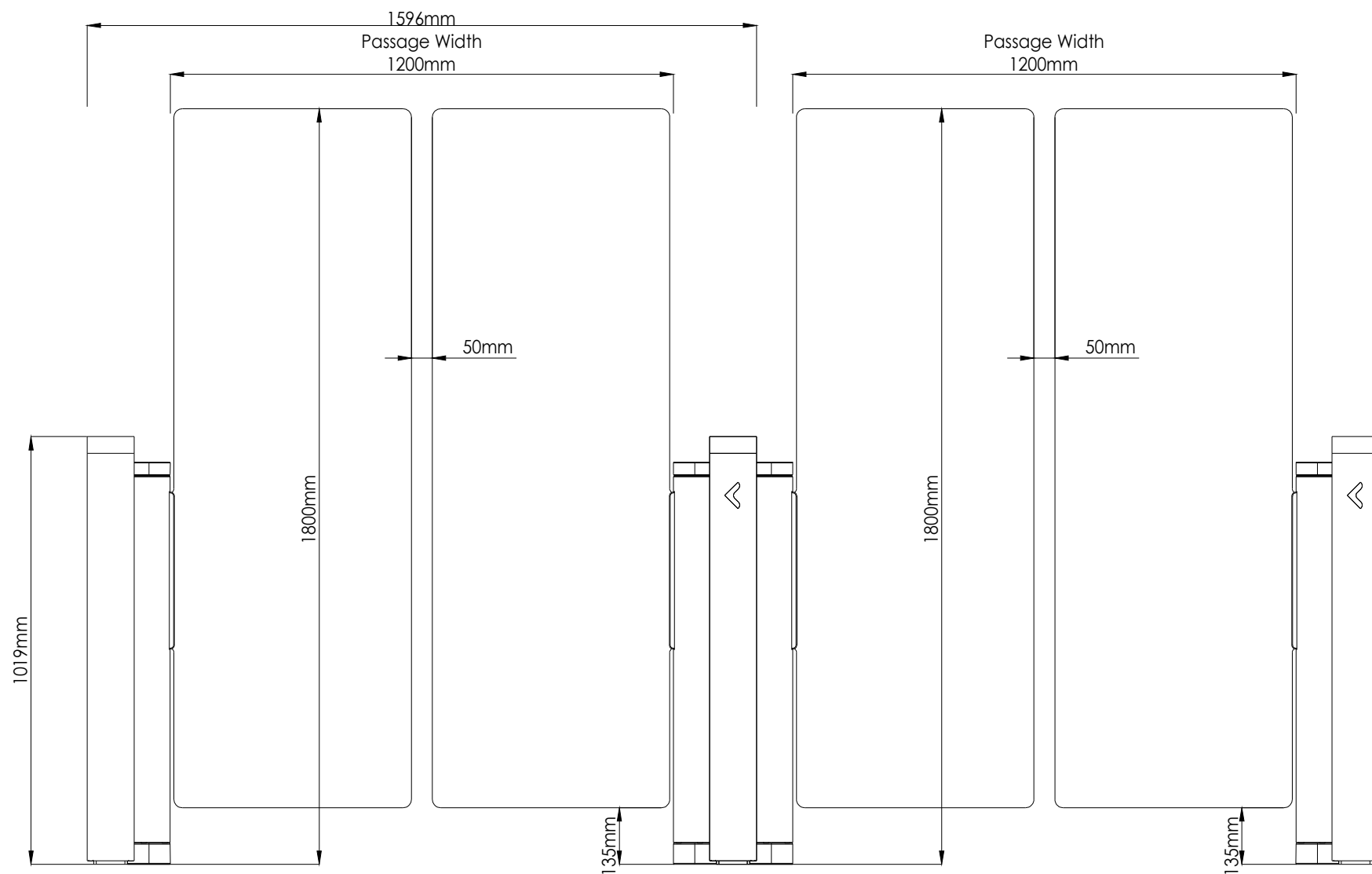

**ASSA ABLOY**

DRAWING NAME:  
SG 400 CENTER GLASS 1750 / 1200-1200-1800

DRAWING NUMBER:  
CD-1214-02

DRAWN	DATE	SIZE	REV
F.C	04.06.2026	A4	Rev-001

SCALE: 1:1 SHEET: 1 OF 1