

D

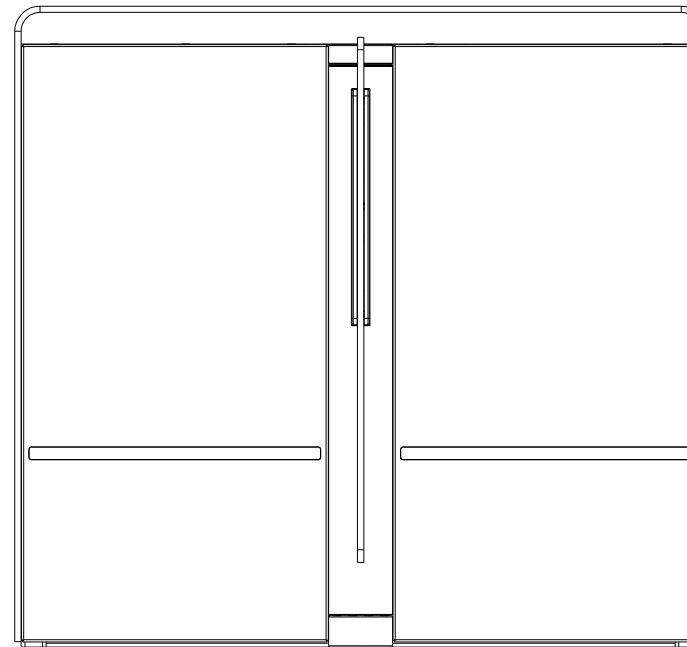

C

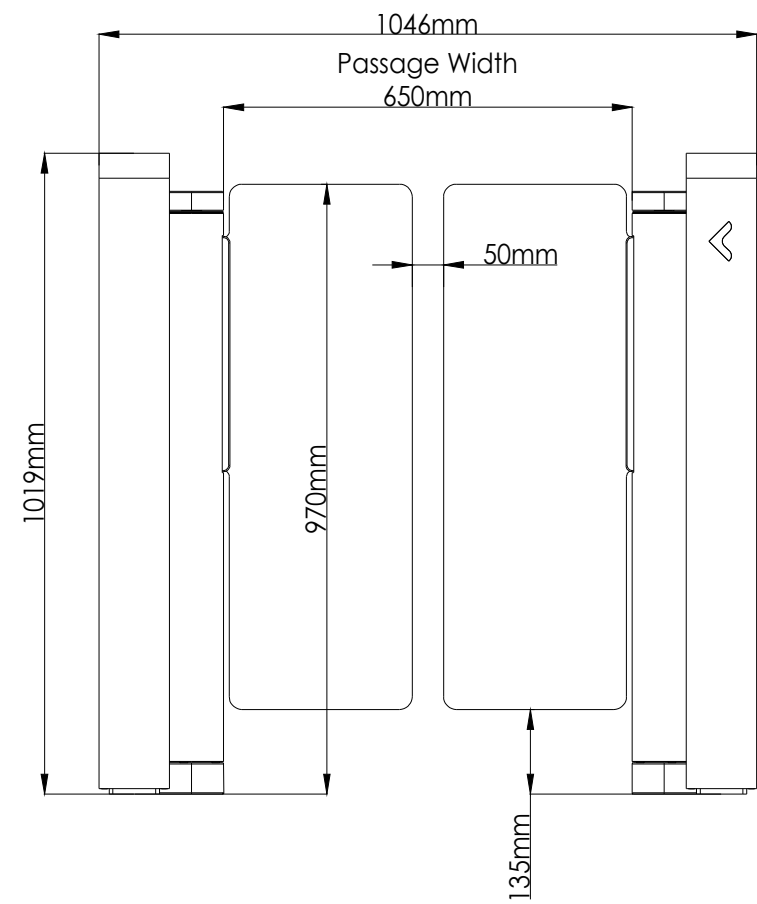
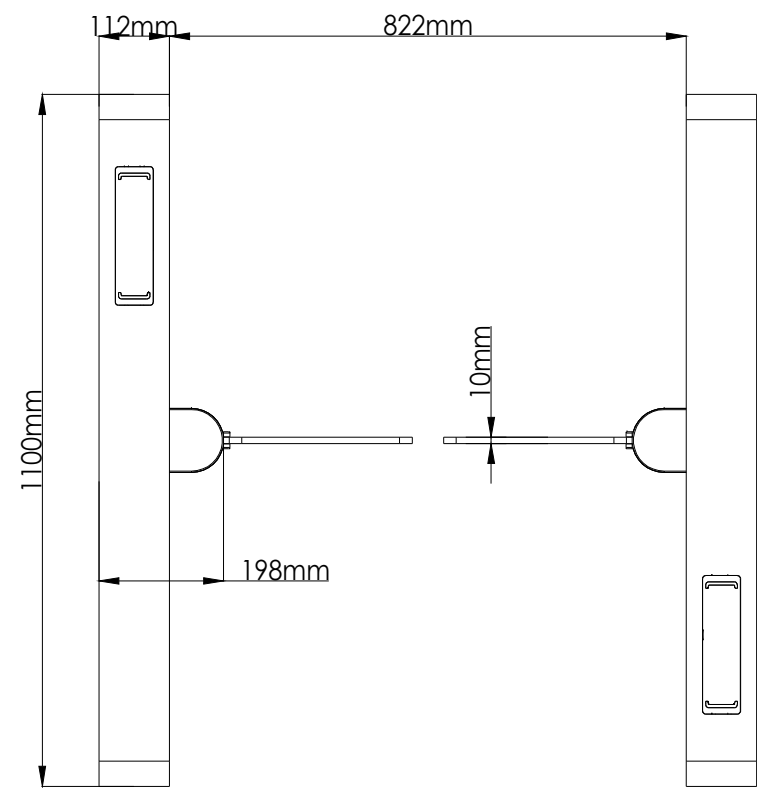

B

A

ASSA ABLOY

DRAWING NAME:
SG 400 BOXED 1100/ 650-970

DRAWING NUMBER:
CD-1131-02

DRAWN	DATE	SIZE	REV
F.C	4.06.2026	A4	Rev.002

D

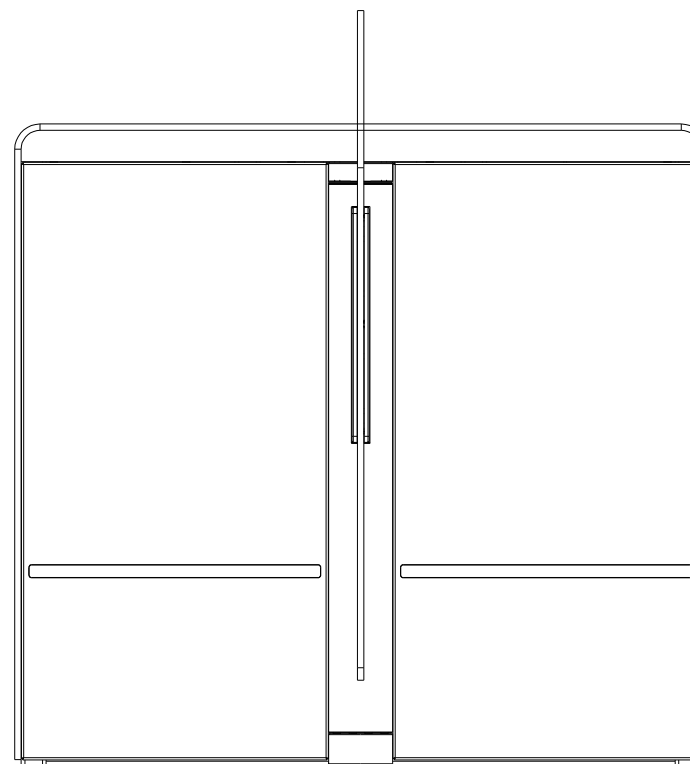
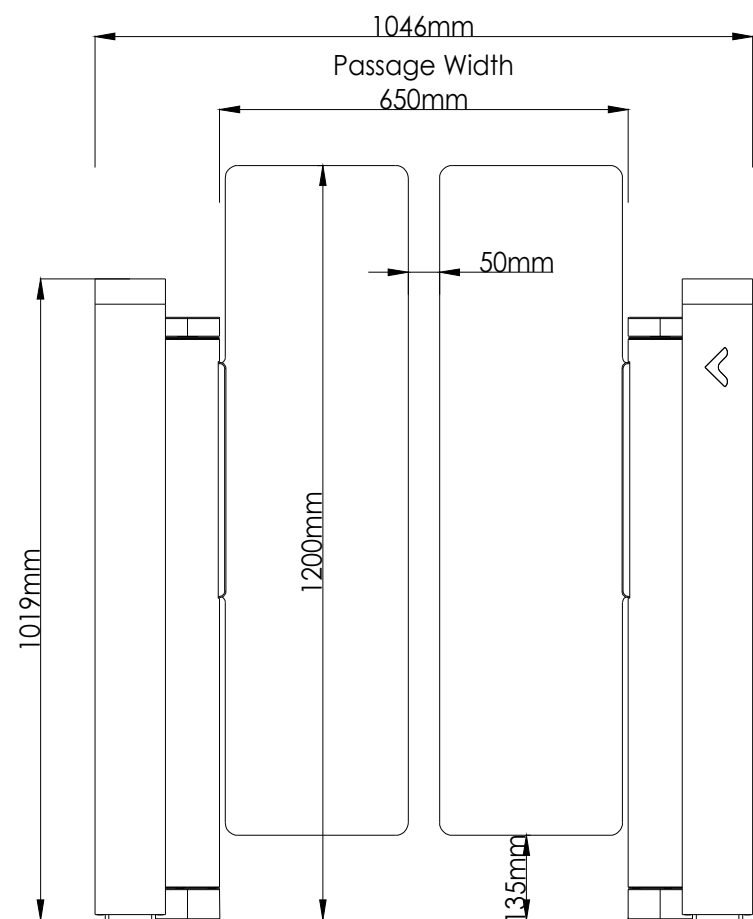

C

B

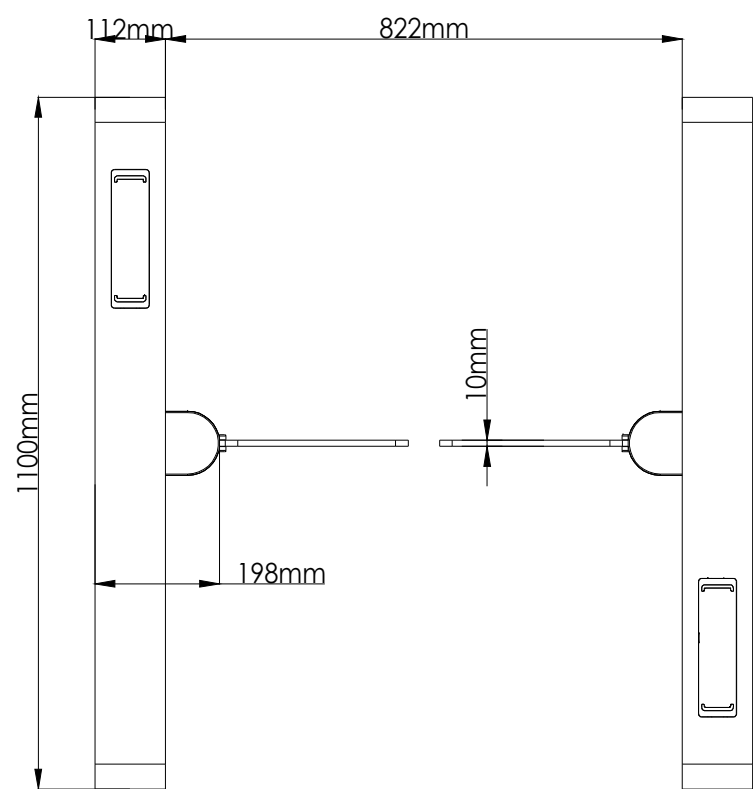

A

ASSA ABLOY

DRAWING NAME:
SG 400 BOXED 1100/ 650-1200

DRAWING NUMBER:
CD-1132-02

DRAWN	DATE	SIZE	REV
F.C	4.06.2026	A4	Rev.002

4

3

2

1

D

C

B

A

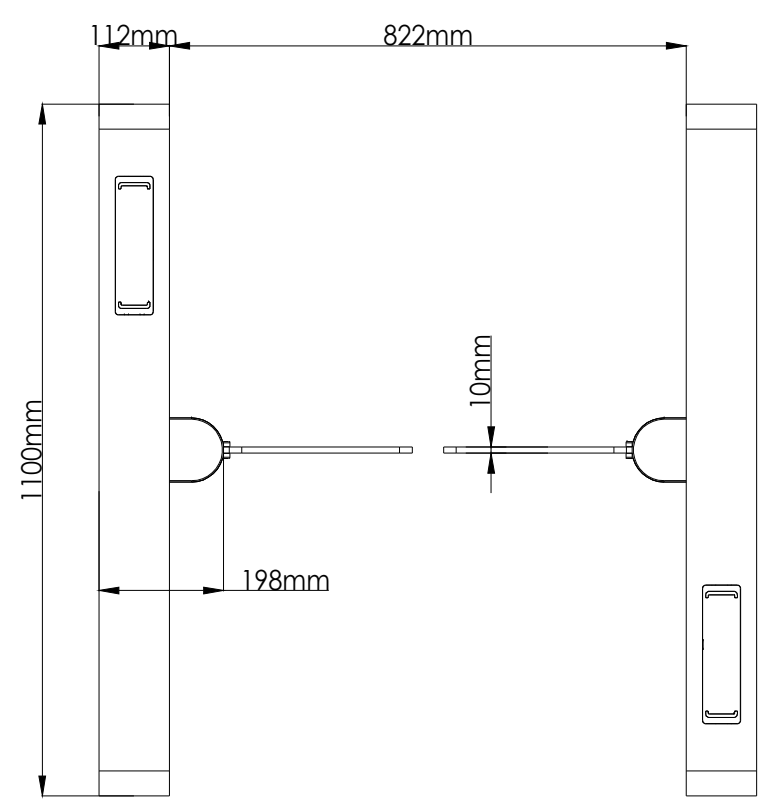
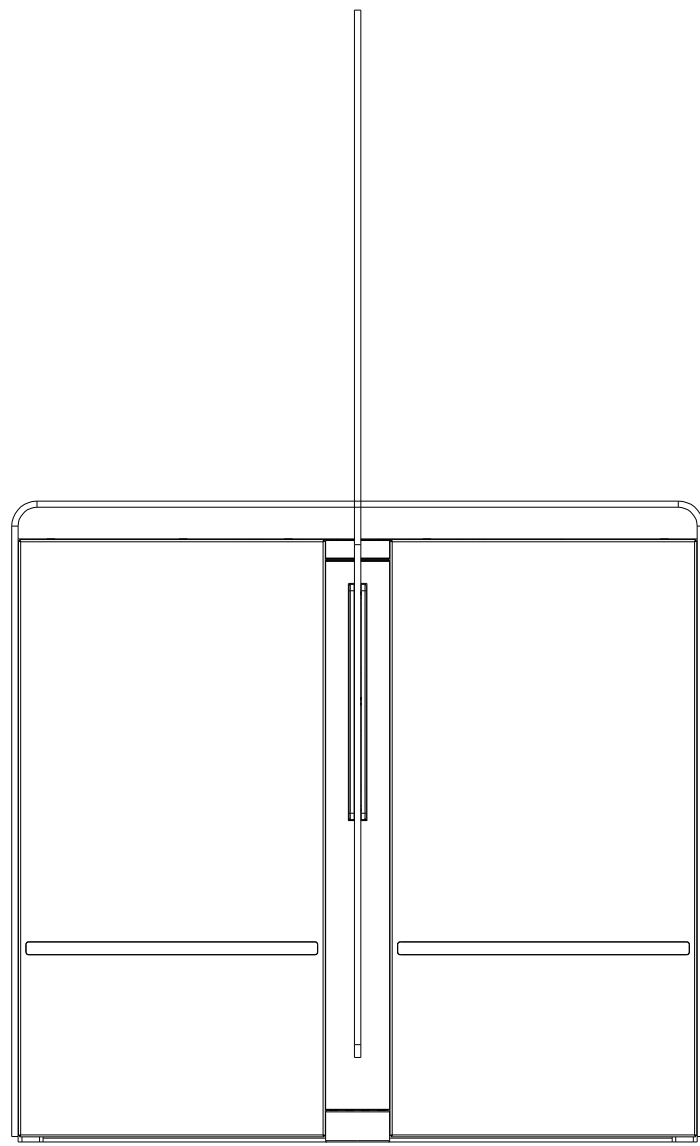
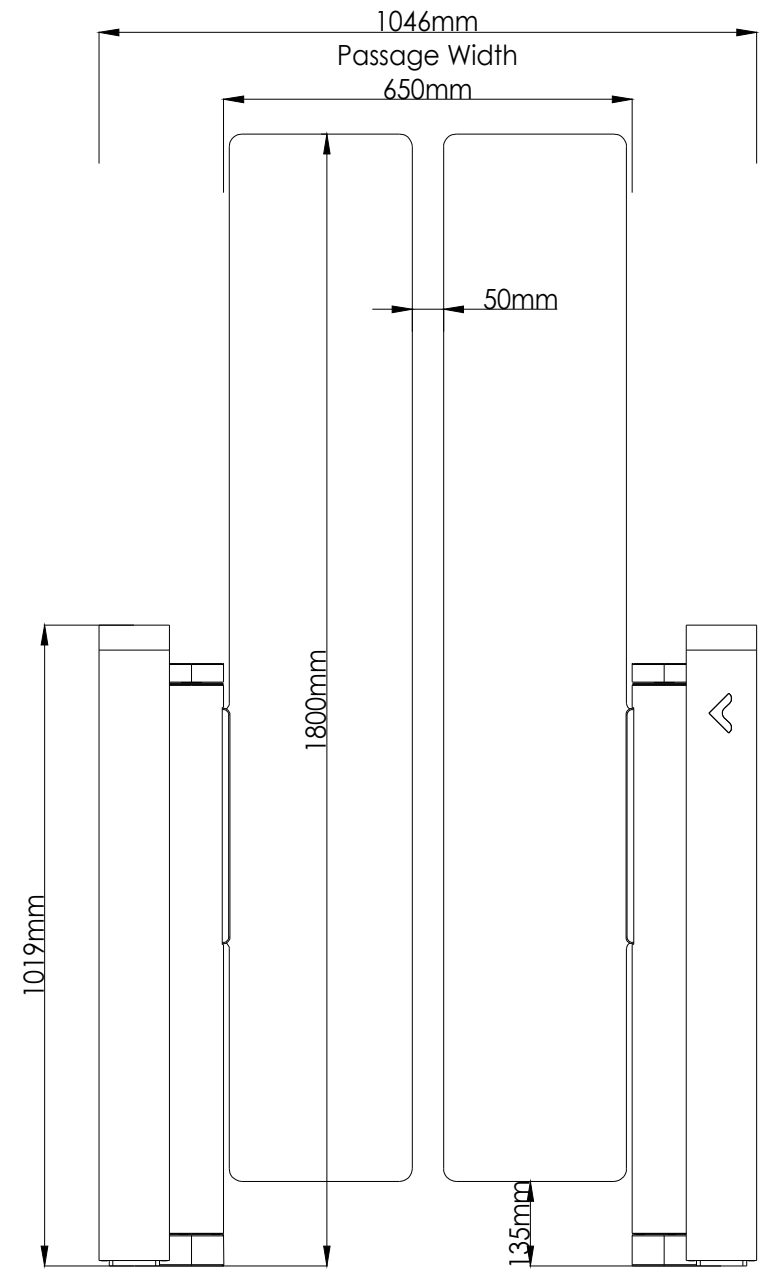

ASSA ABLOY

DRAWING NAME:
SG 400 BOXED 1100/ 650-1800

DRAWING NUMBER:
CD-1133-02

DRAWN F.C	DATE 4.06.2026	SIZE A4	REV Rev.002
--------------	-------------------	------------	----------------

D

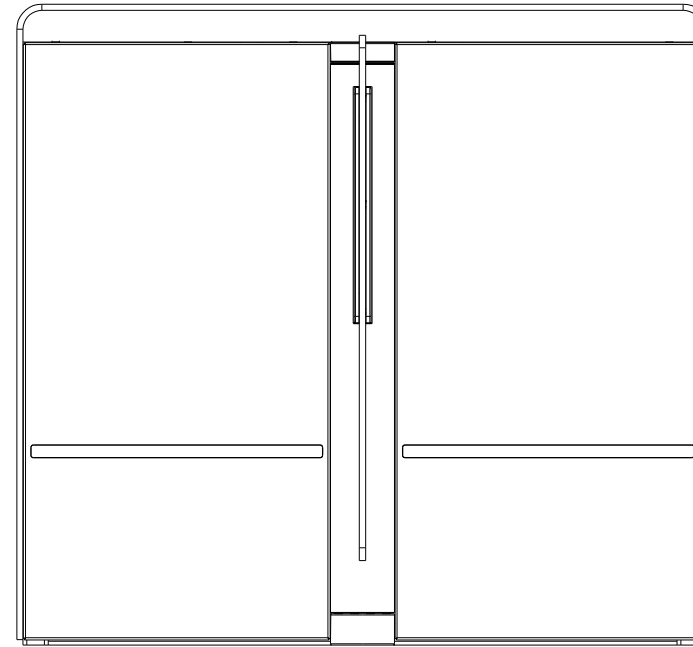
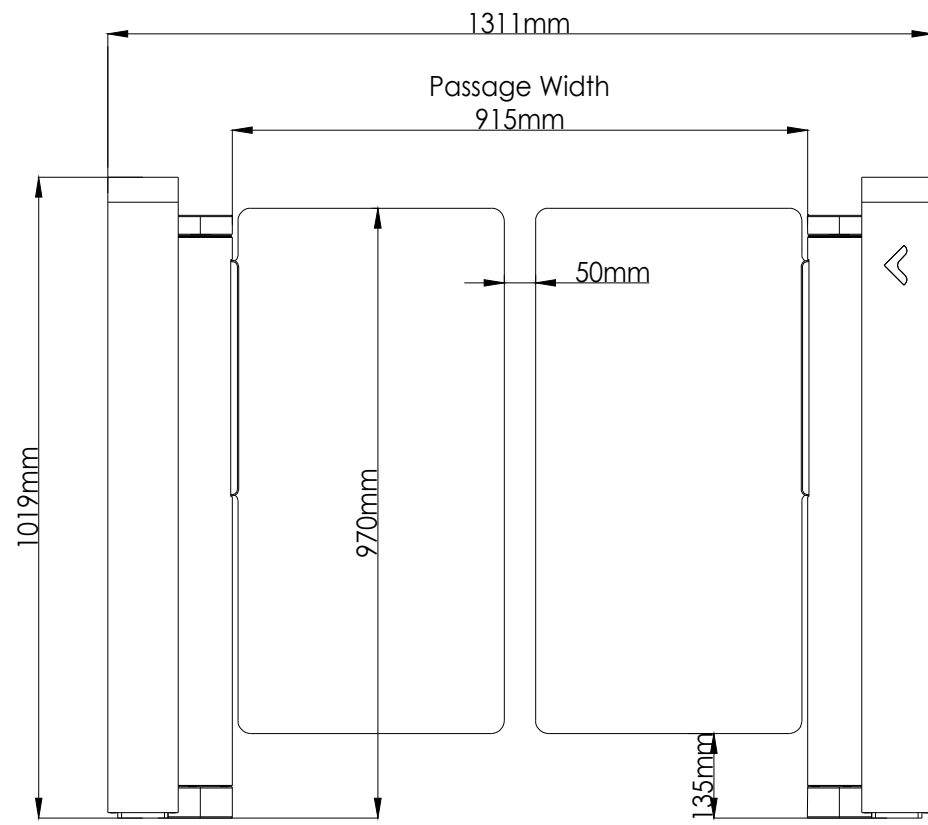

C

B

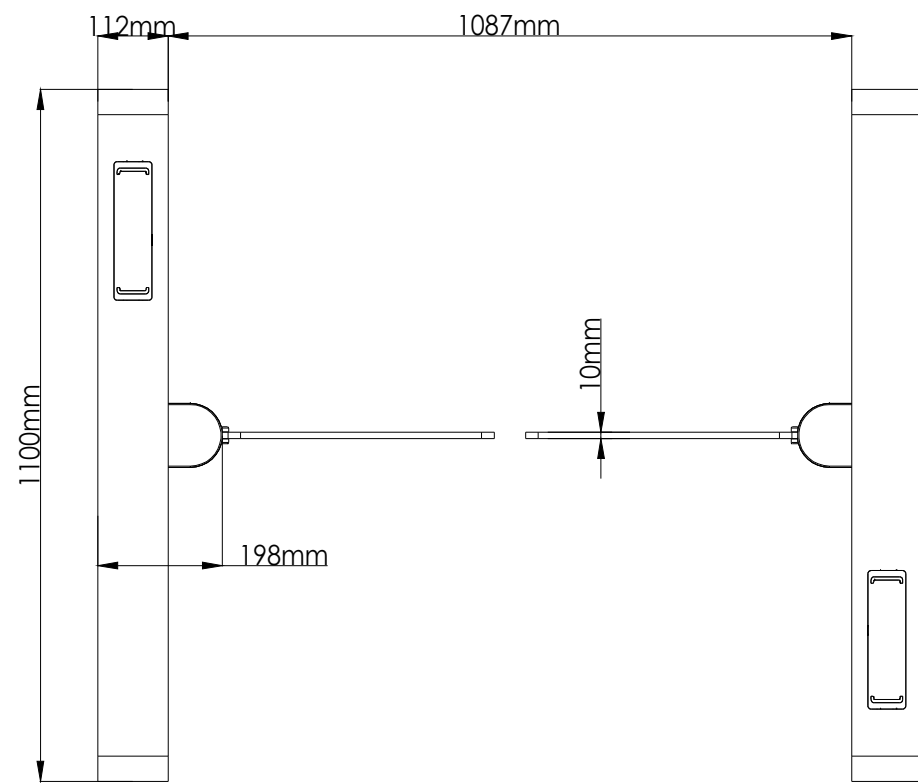

A

ASSA ABLOY

DRAWING NAME:
SG 400 BOXED 1100/ 915-970

DRAWING NUMBER:
CD-1134-02

DRAWN	DATE	SIZE	REV
F.C	4.06.2026	A4	Rev.002

D

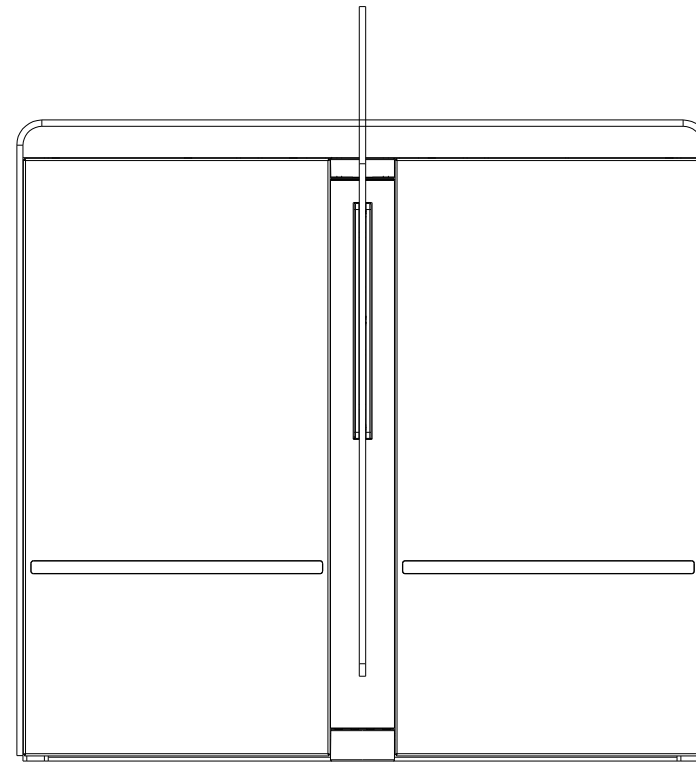
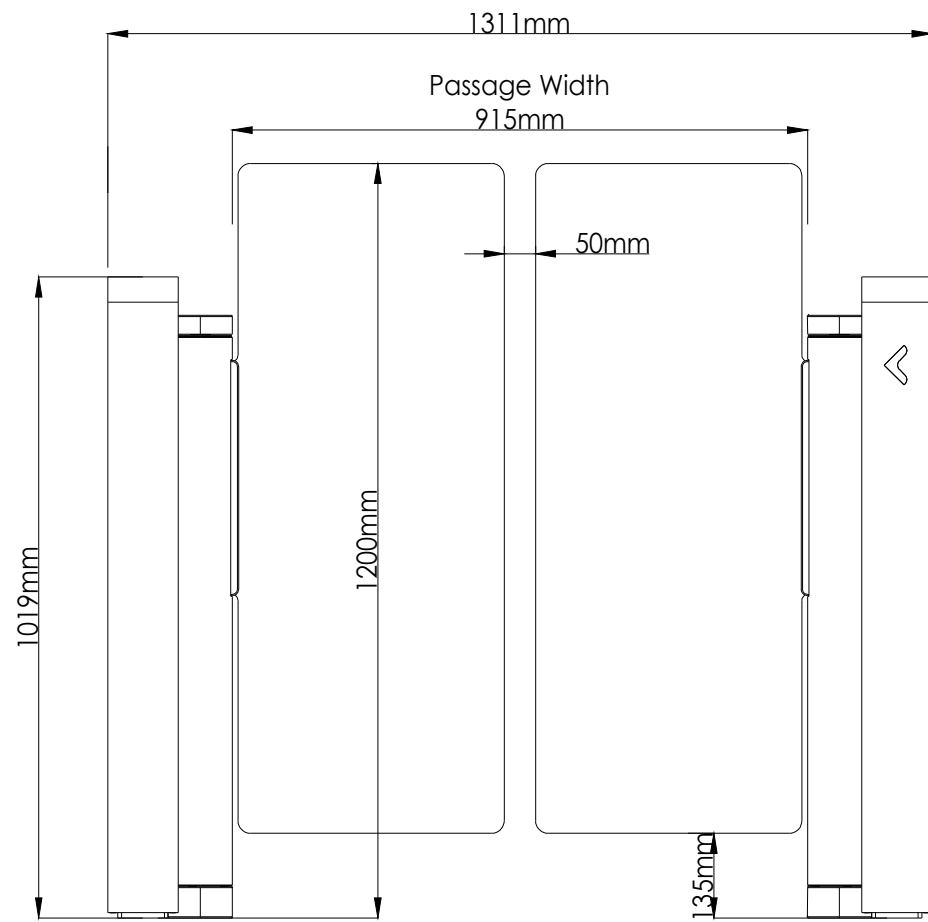

C

B

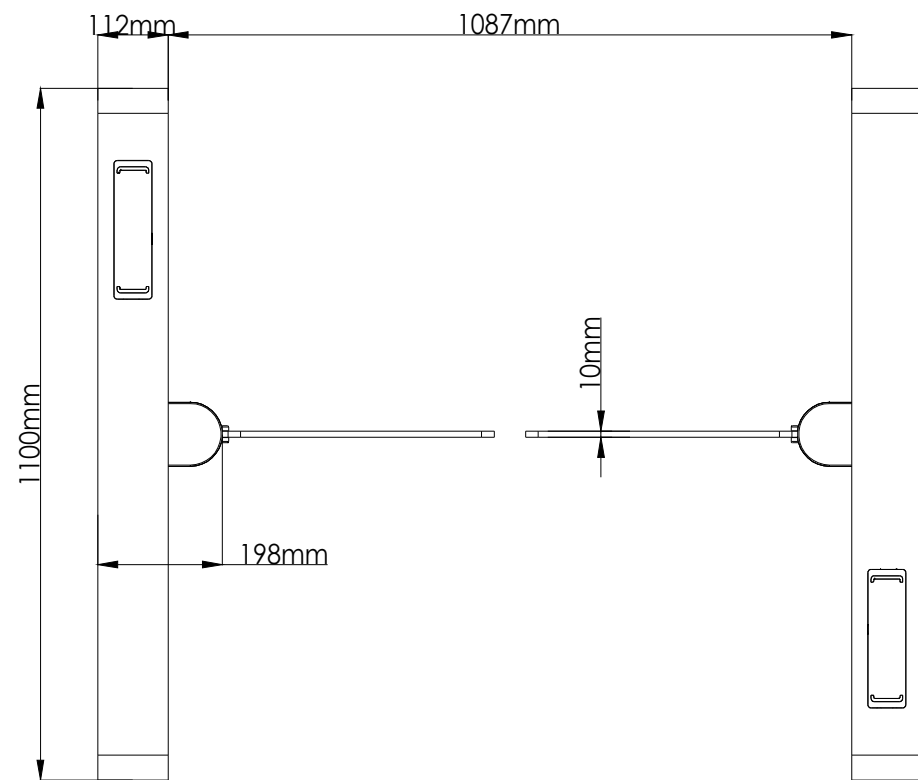

A

ASSA ABLOY

DRAWING NAME:
SG 400 BOXED 1100/ 915-1200

DRAWING NUMBER:
CD-1135-02

DRAWN	DATE	SIZE	REV
F.C	4.06.2026	A4	Rev.002

4

3

2

1

D

C

B

A

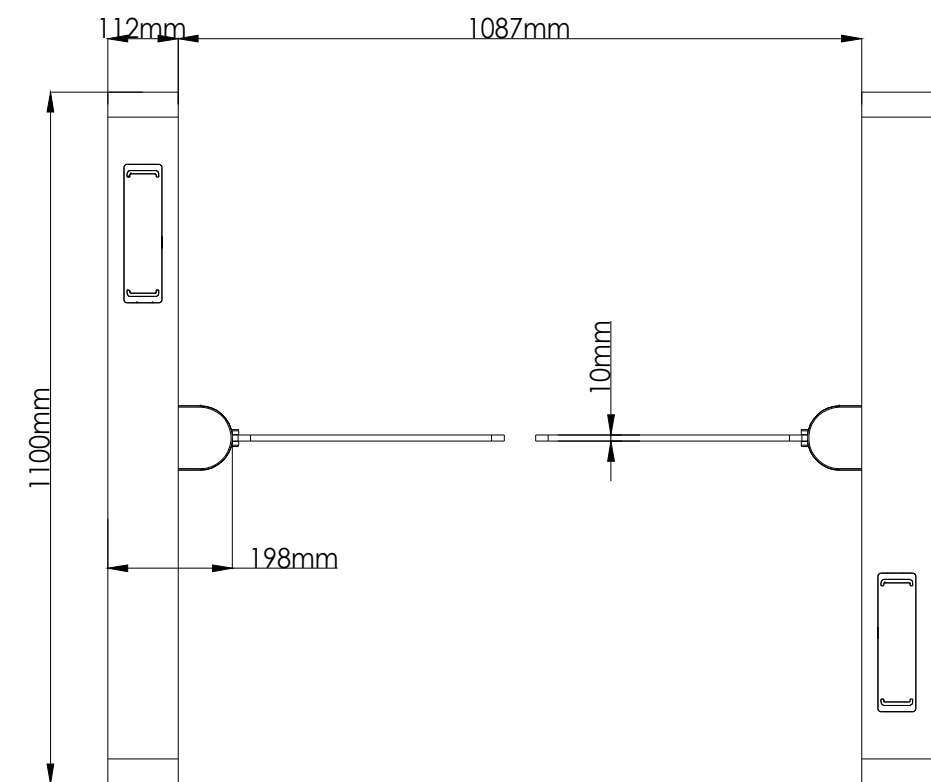
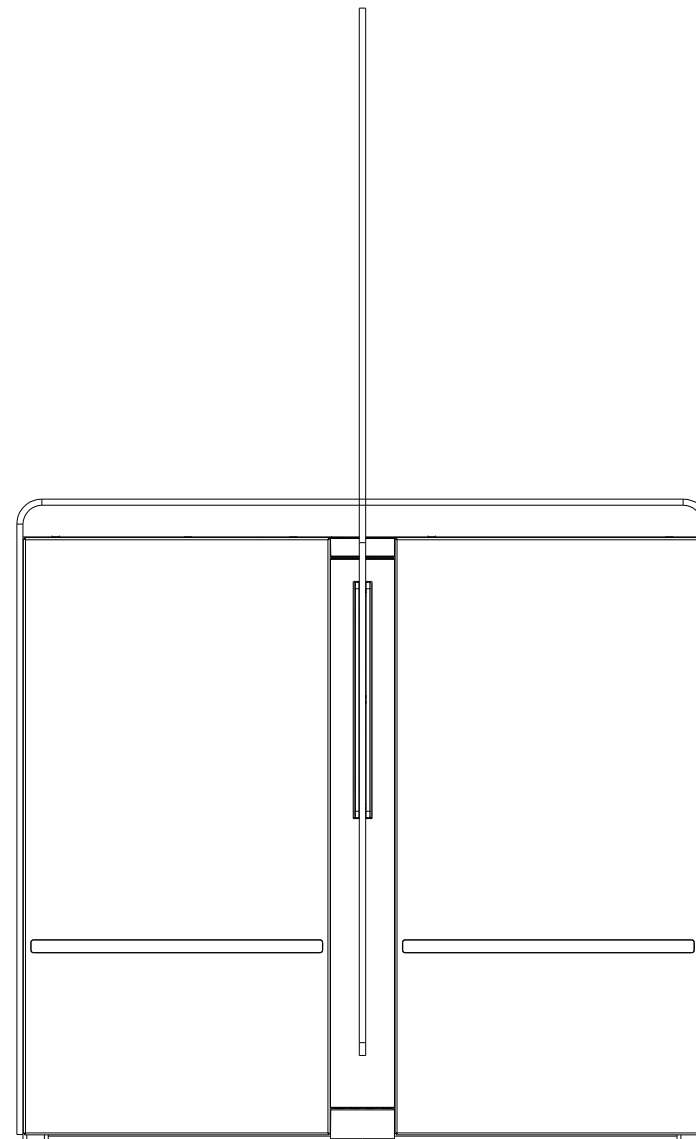
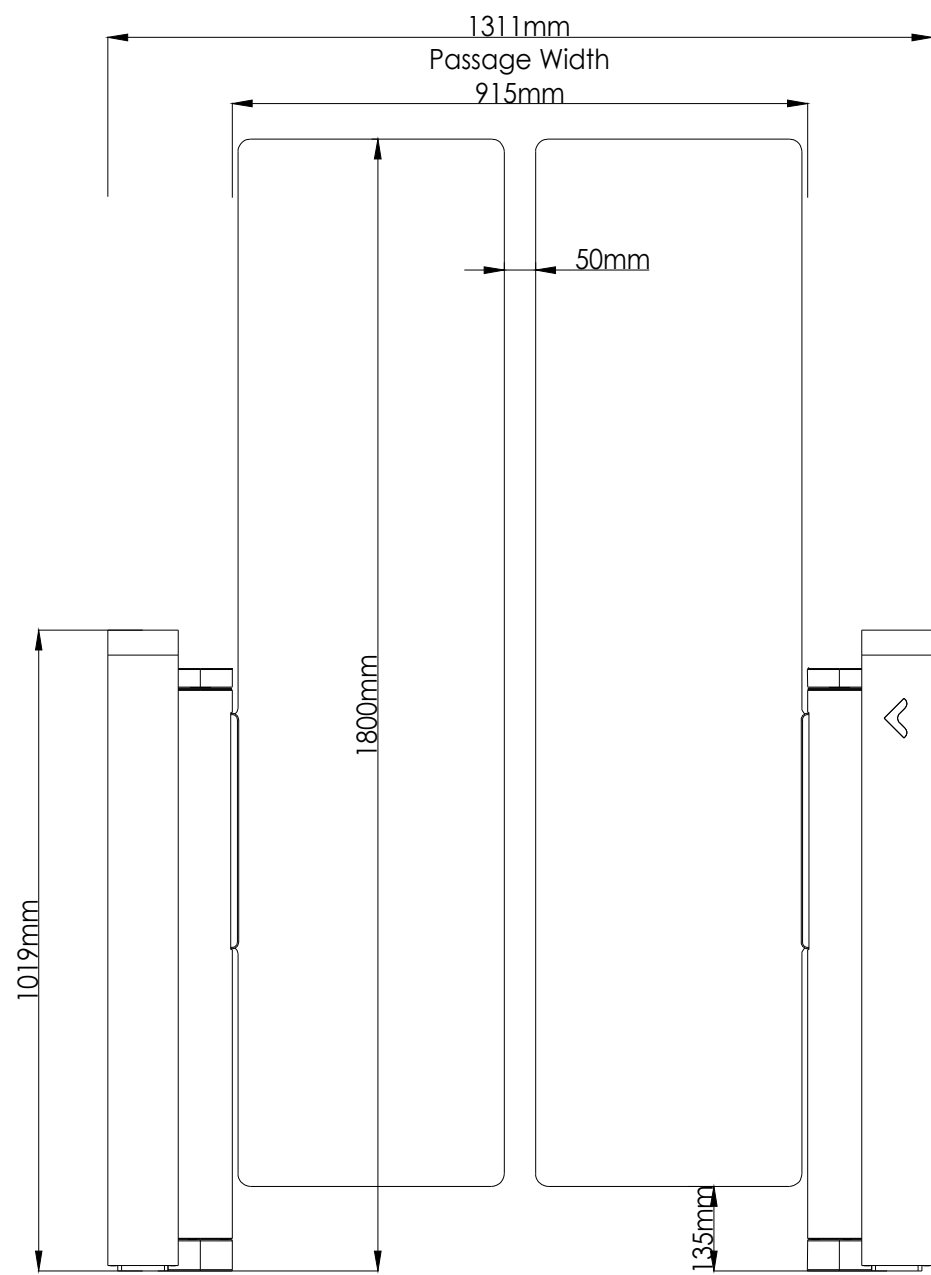

ASSA ABLOY

DRAWING NAME:
SG 400 BOXED 1100/ 915-1800

DRAWING NUMBER:
CD-1136-02

DRAWN	DATE	SIZE	REV
F.C	4.06.2026	A4	Rev.002

D

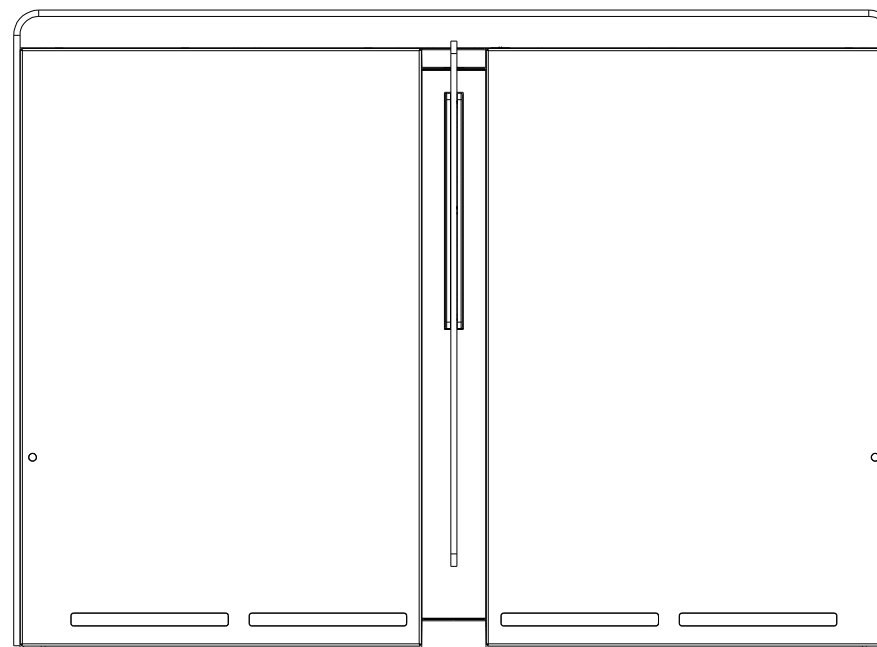
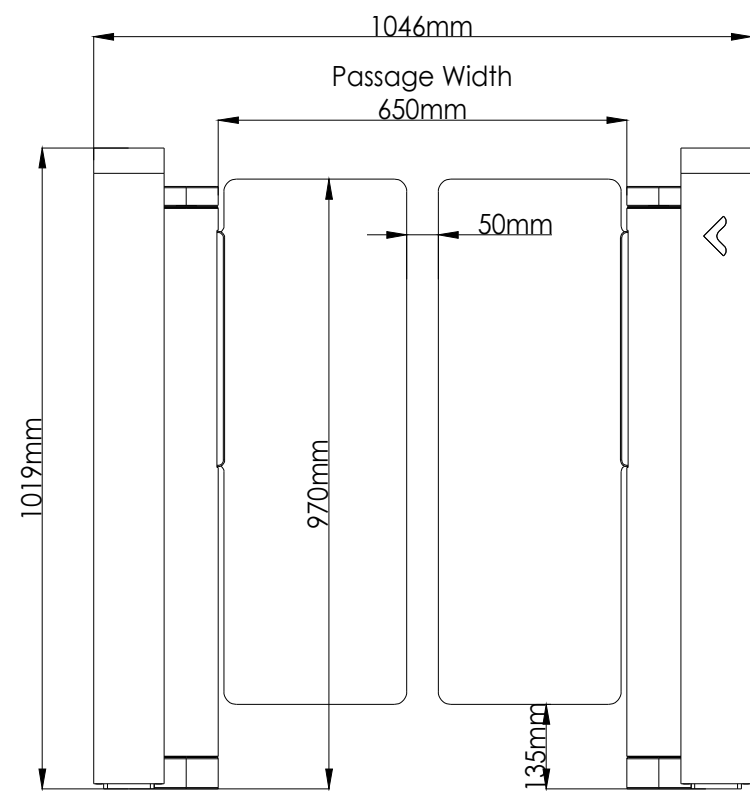

C

B

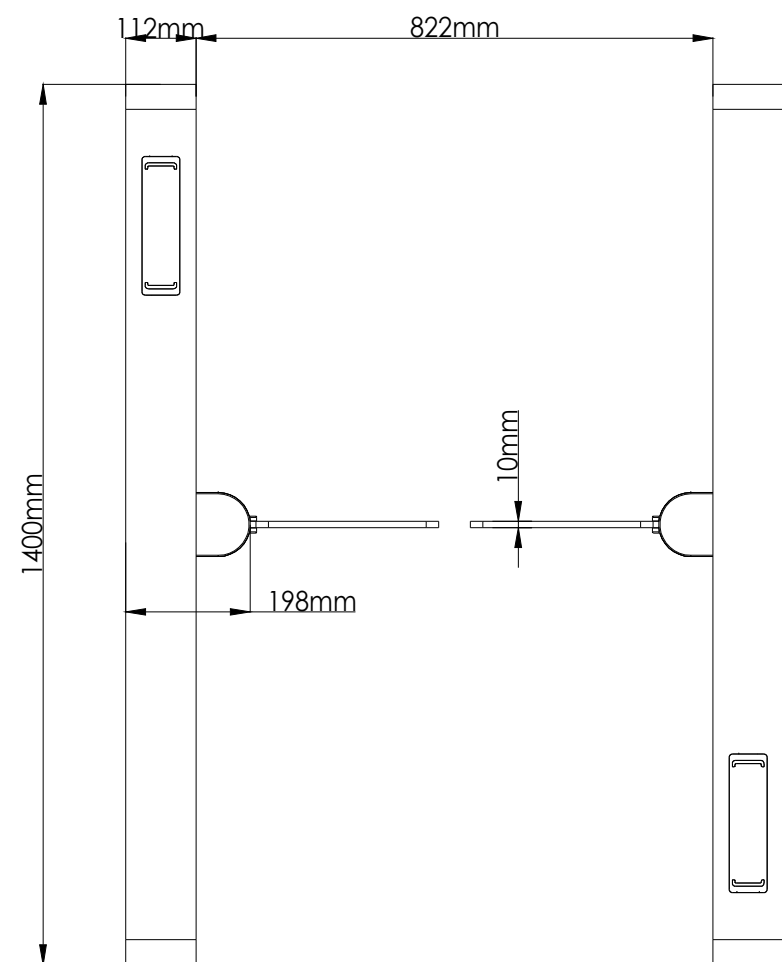

A

ASSA ABLOY

DRAWING NAME:
SG 400 BOXED 1400/ 650-970

DRAWING NUMBER:
CD-1137-02

DRAWN	DATE	SIZE	REV
F.C	4.06.2026	A4	Rev.002

4

3

2

1

D

C

B

A

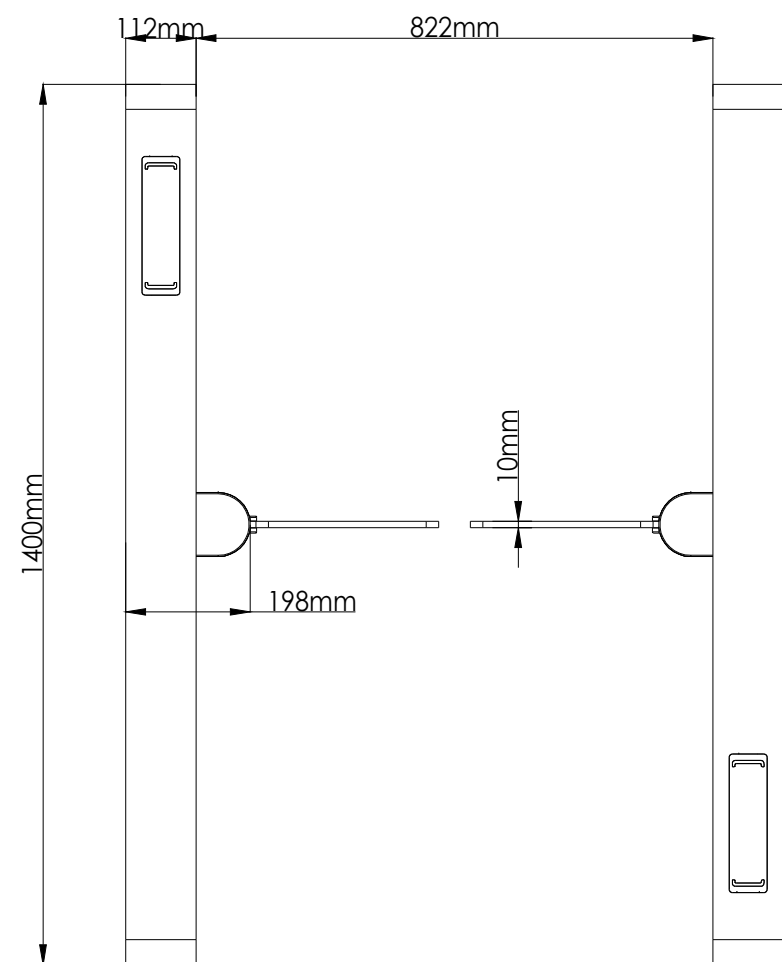
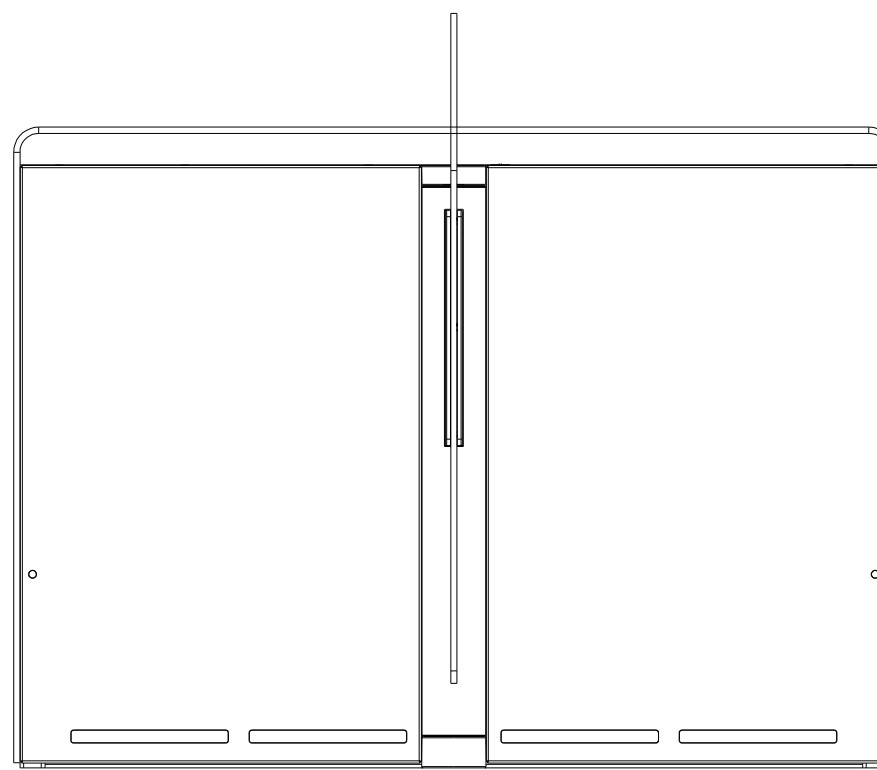
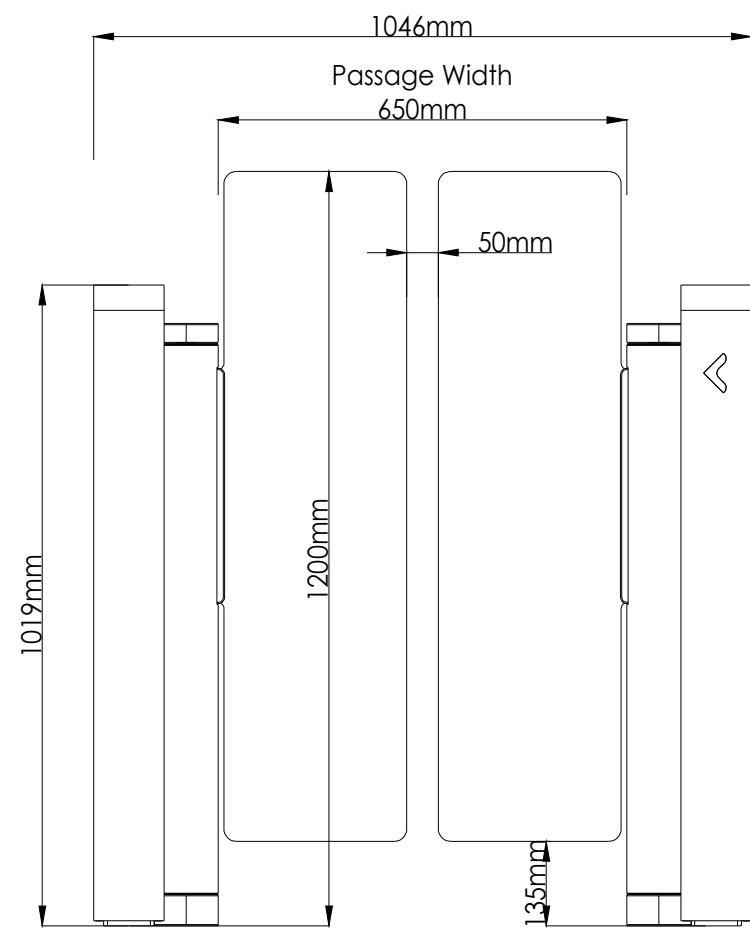

ASSA ABLOY

DRAWING NAME:
SG 400 BOXED 1400/ 650-1200

DRAWING NUMBER:
CD-1138-02

DRAWN	DATE	SIZE	REV
F.C	4.06.2026	A4	Rev.002

4

3

2

1

D

C

B

A

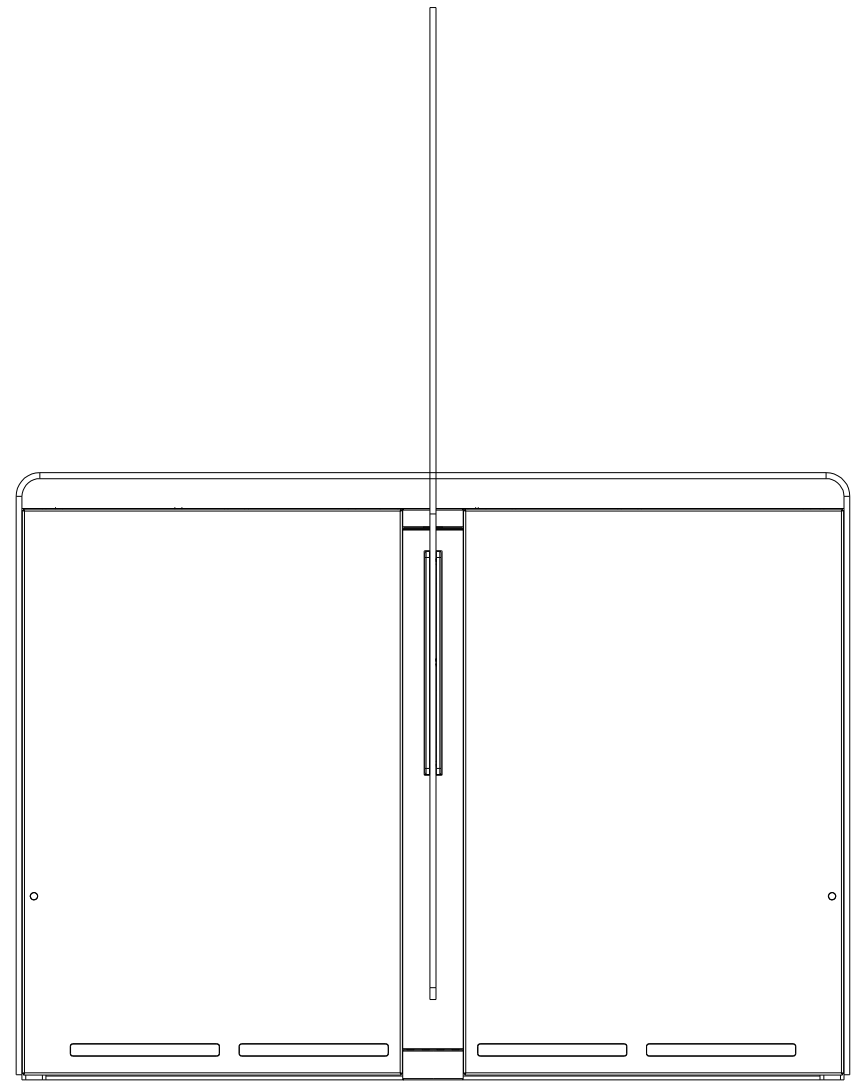
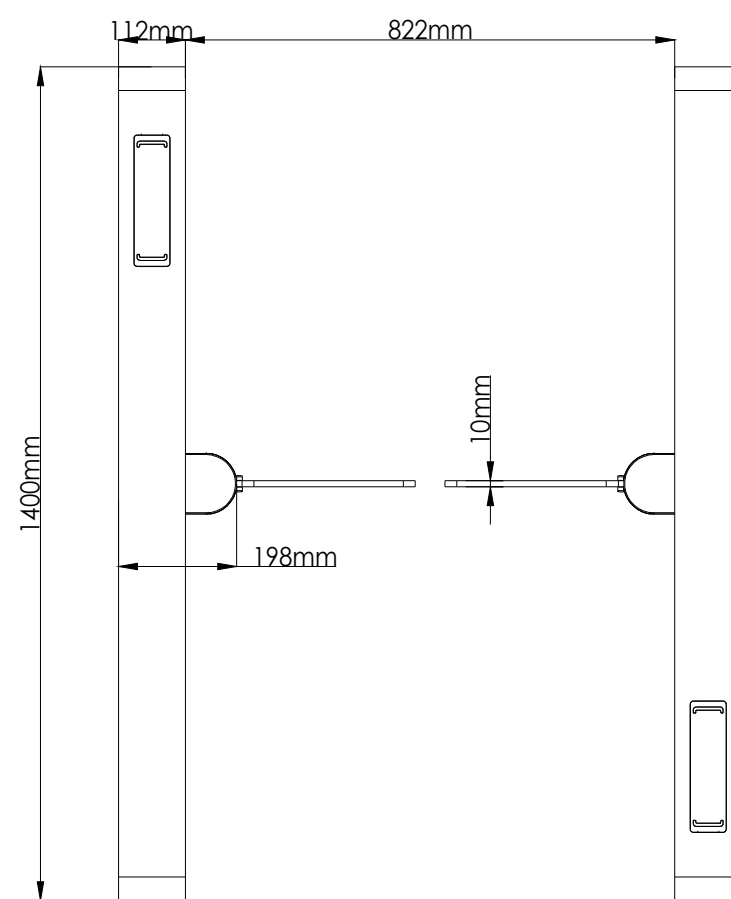
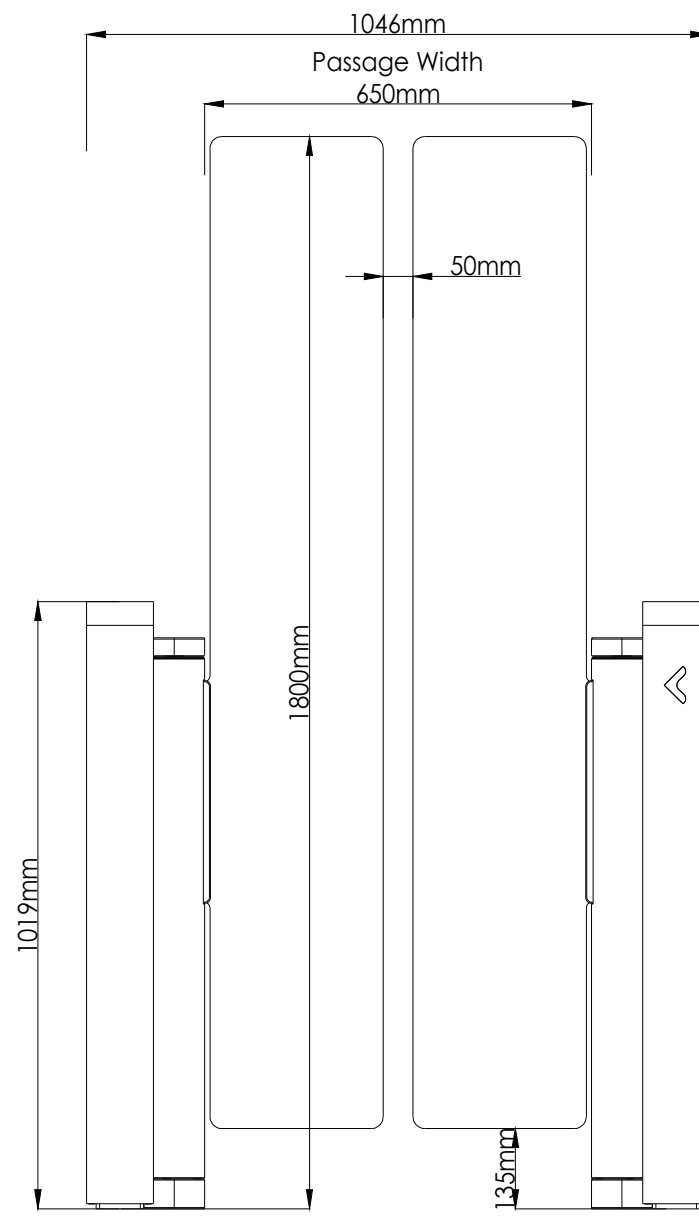

ASSA ABLOY			
DRAWING NAME: SG 400 BOXED 1400/ 650-1800			
DRAWING NUMBER: CD-1139-02			
DRAWN F.C	DATE 4.06.2026	SIZE A4	REV Rev.002
SHEET: 1 OF 1			

D

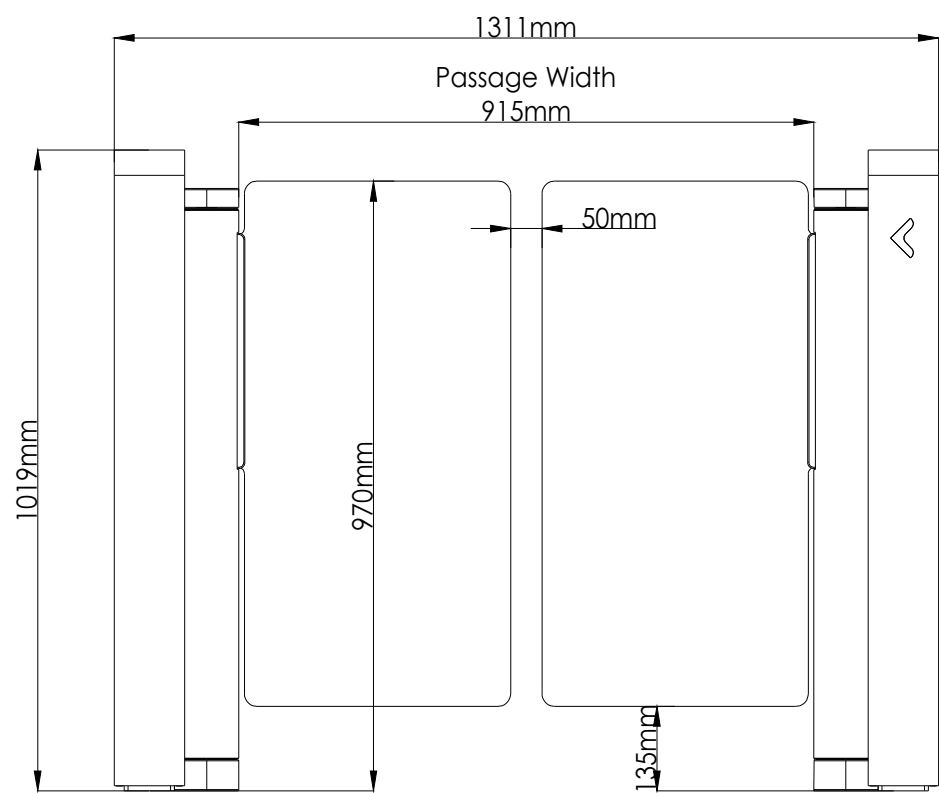

C

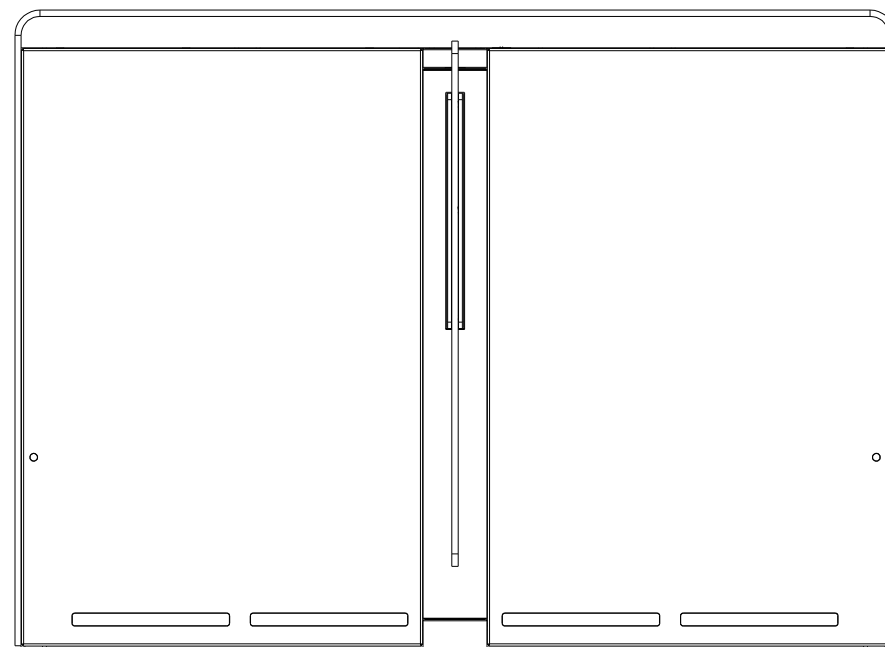

B

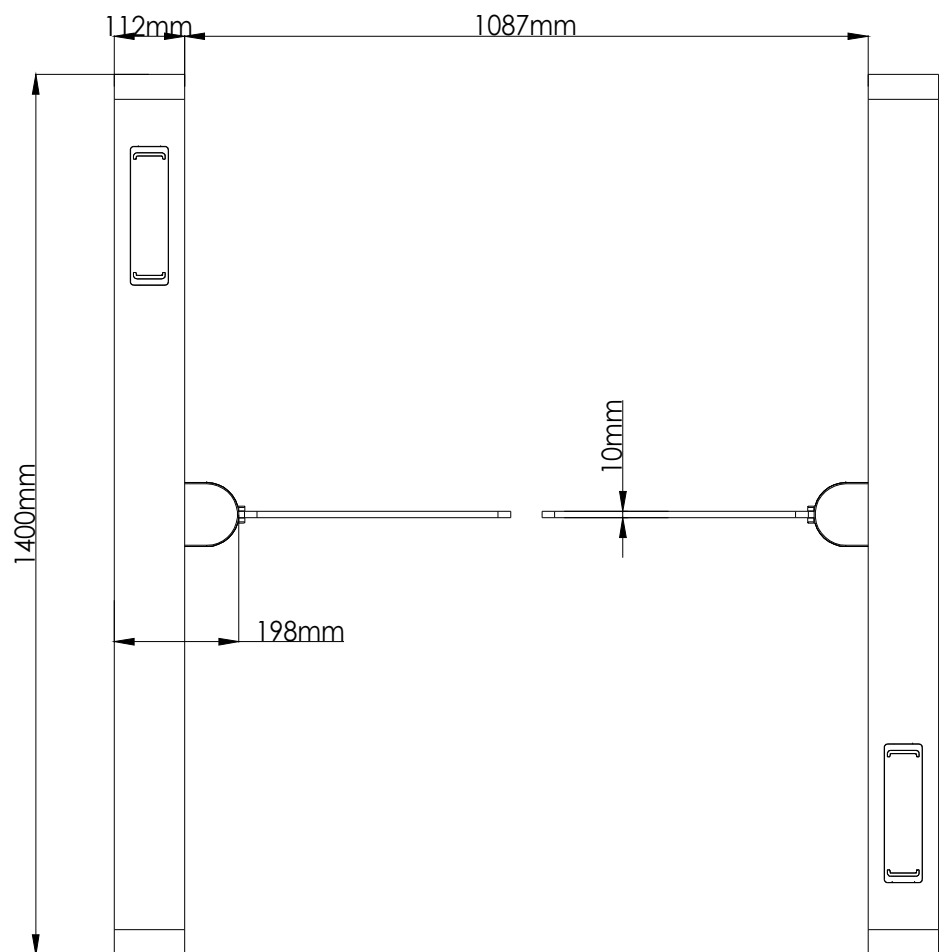

A

ASSA ABLOY

DRAWING NAME:
SG 400 BOXED 1400/ 915-970

DRAWING NUMBER:
CD-1140-02

DRAWN F.C	DATE 4.06.2026	SIZE A4	REV Rev.002
--------------	-------------------	------------	----------------

4

3

2

1

D

C

B

A

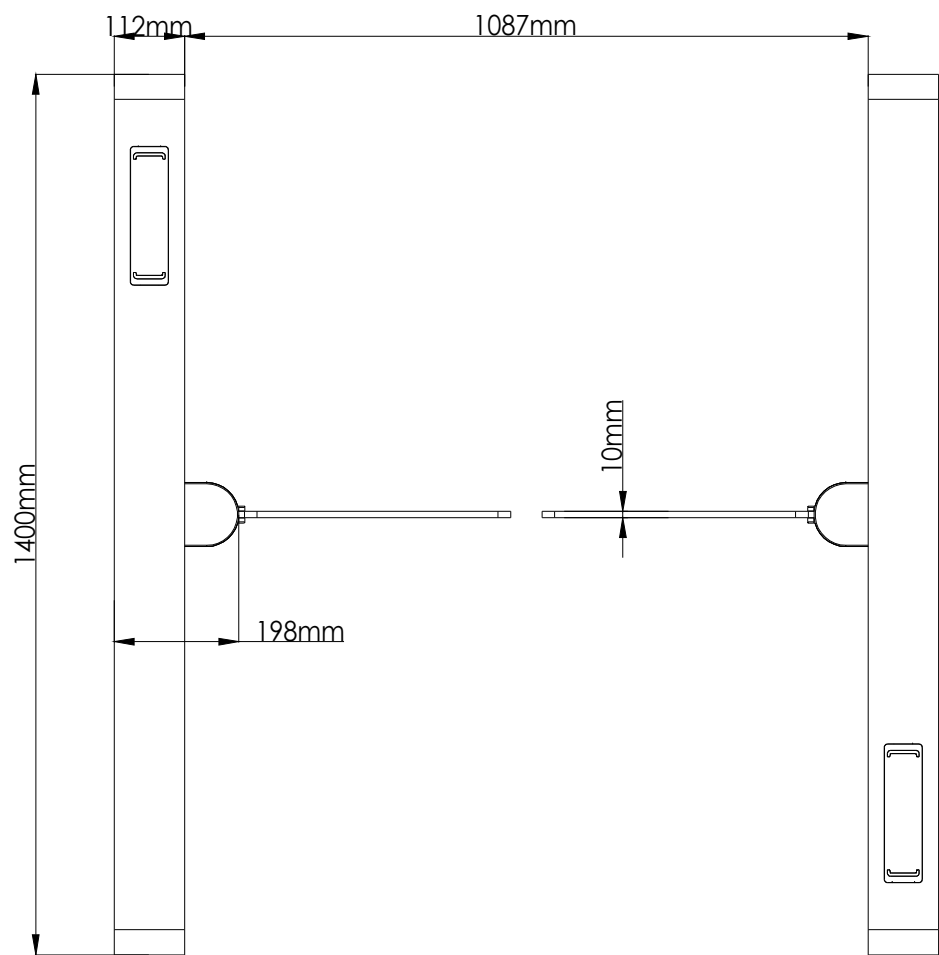
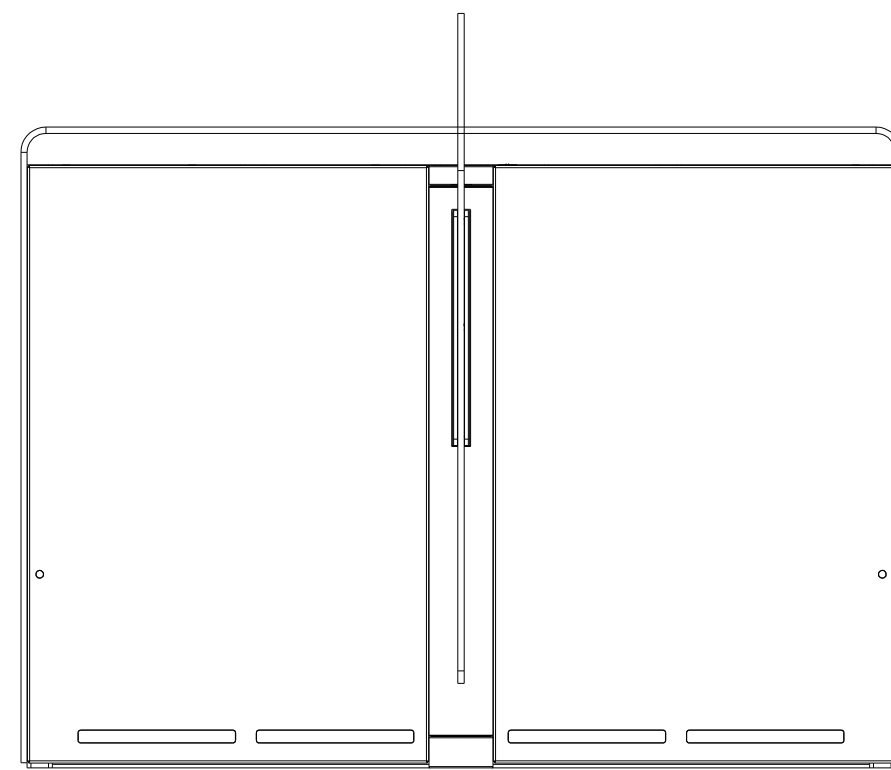
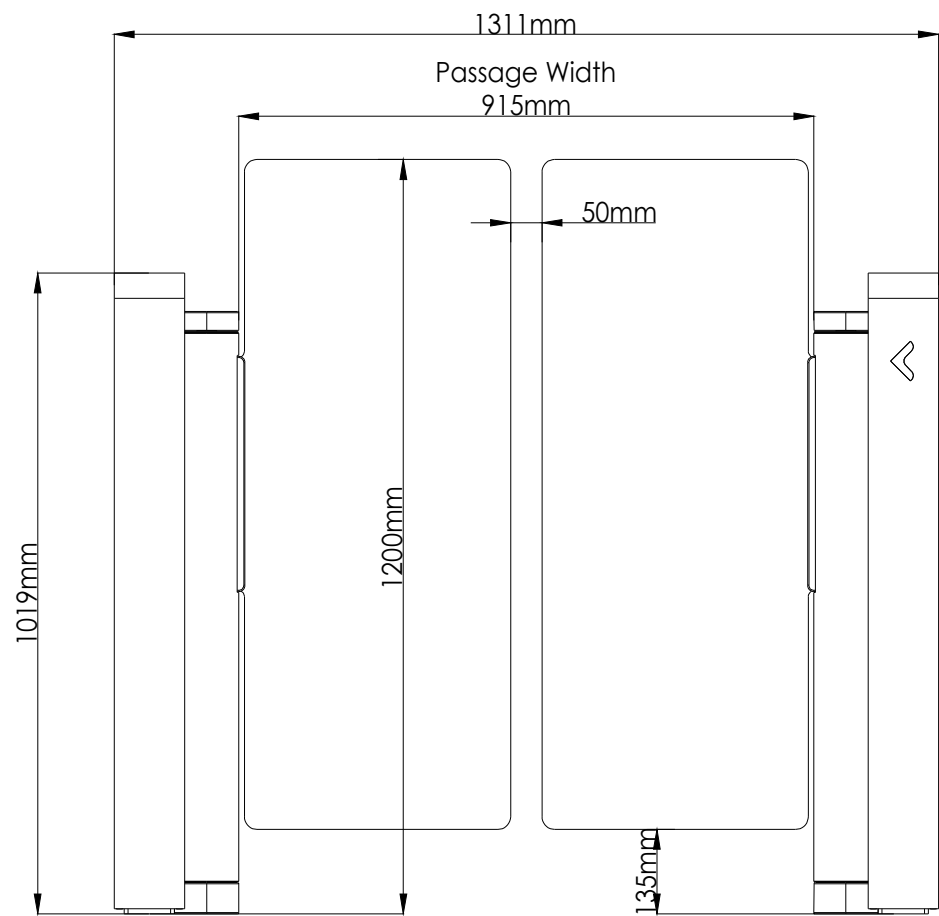

ASSA ABLOY

DRAWING NAME:
SG 400 BOXED 1400/ 915-1200

DRAWING NUMBER:
CD-1141-02

DRAWN	DATE	SIZE	REV
F.C	4.06.2026	A4	Rev.002

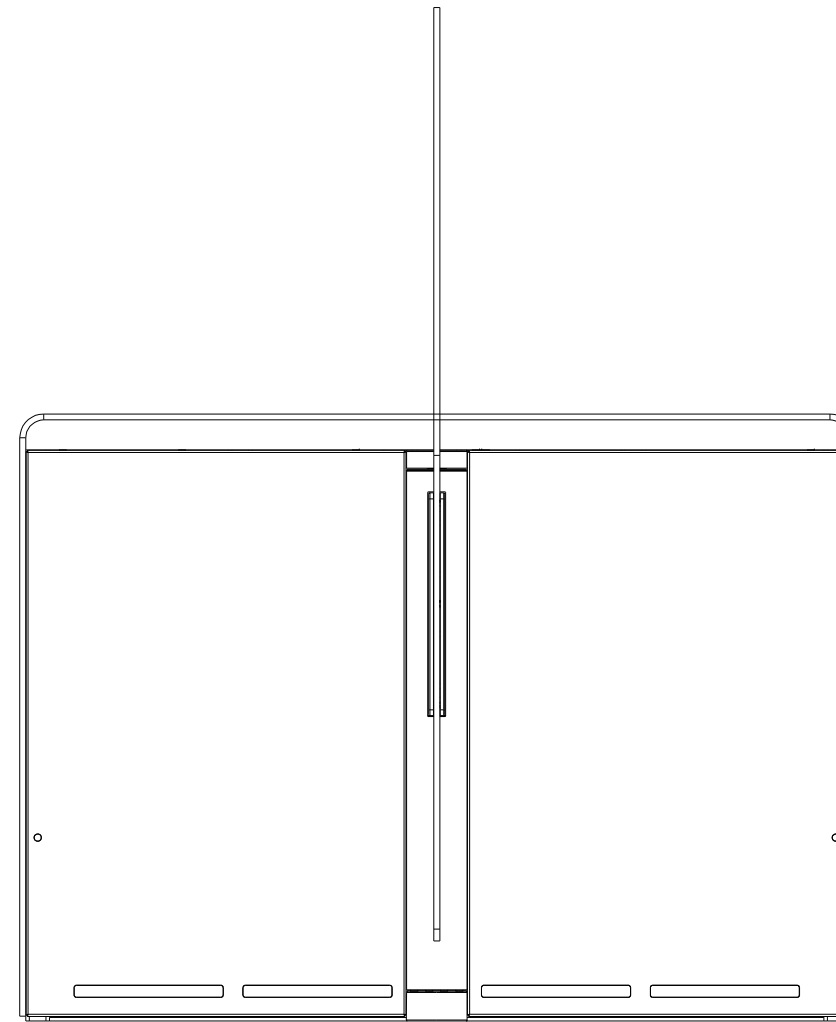
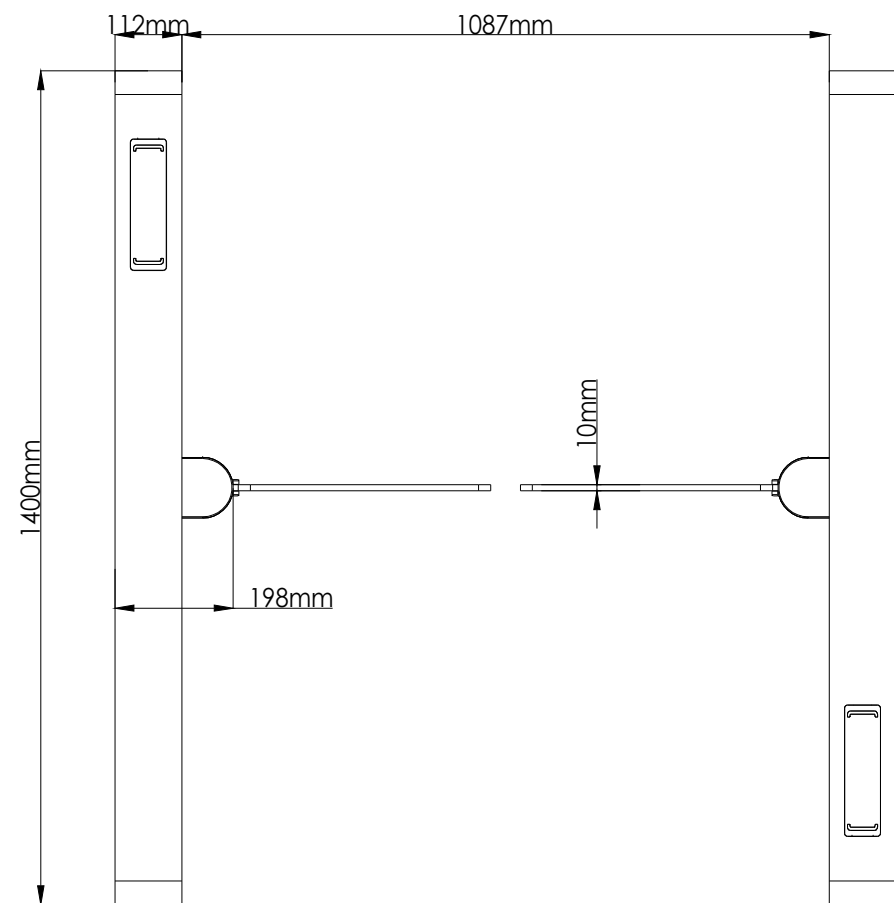
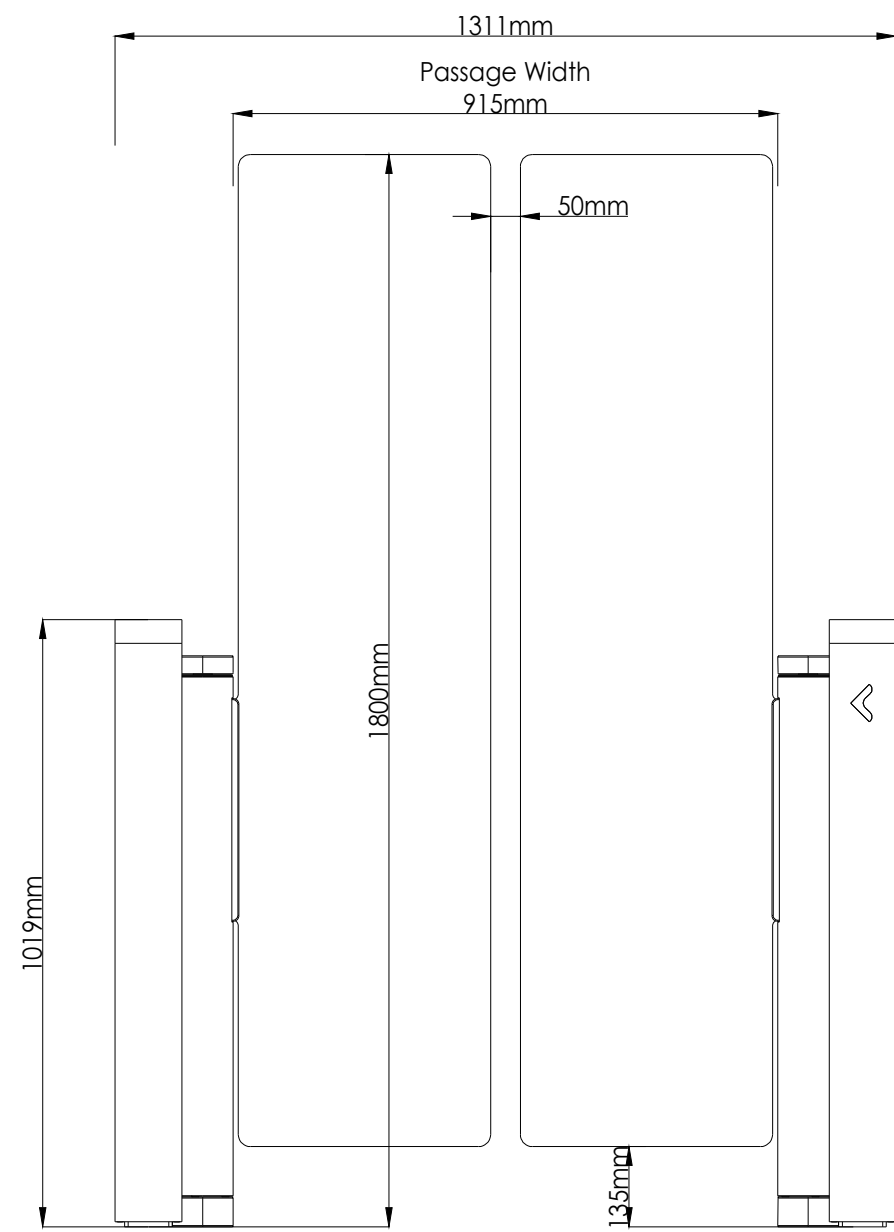

ASSA ABLOY			
DRAWING NAME: SG 400 BOXED1400/ 915-1800			
DRAWING NUMBER: CD-1142-02			
DRAWN F.C	DATE 4.06.2026	SIZE A4	REV Rev.002
SHEET: 1 OF 1			

D

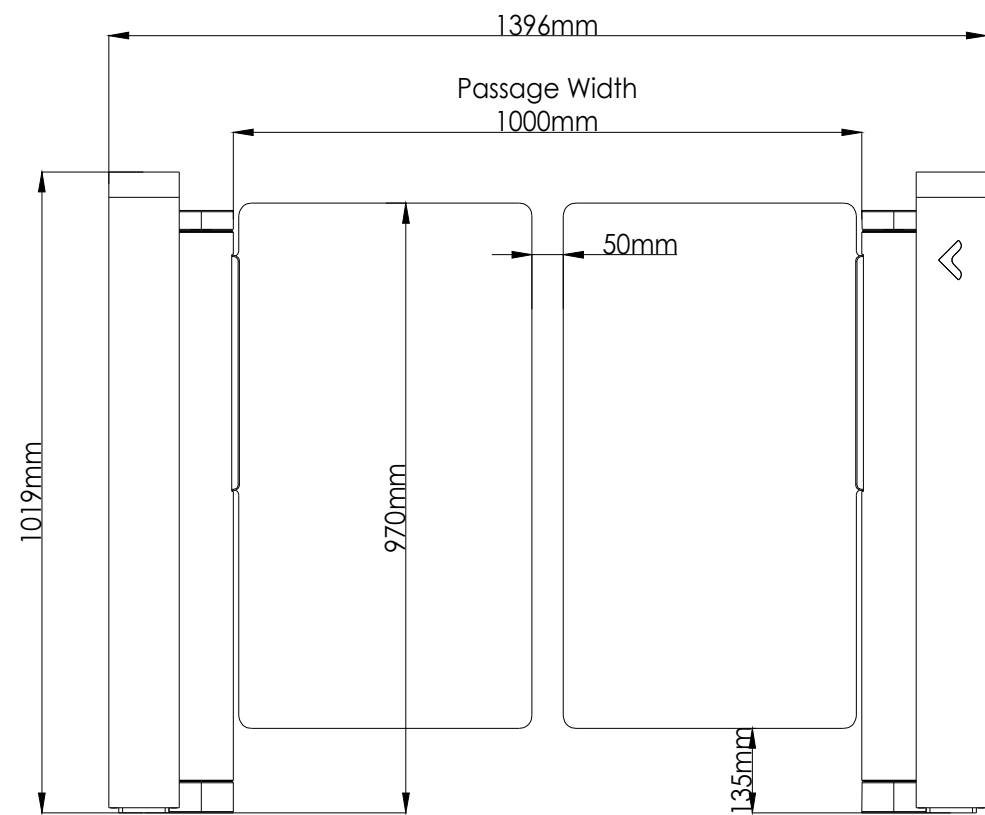

C

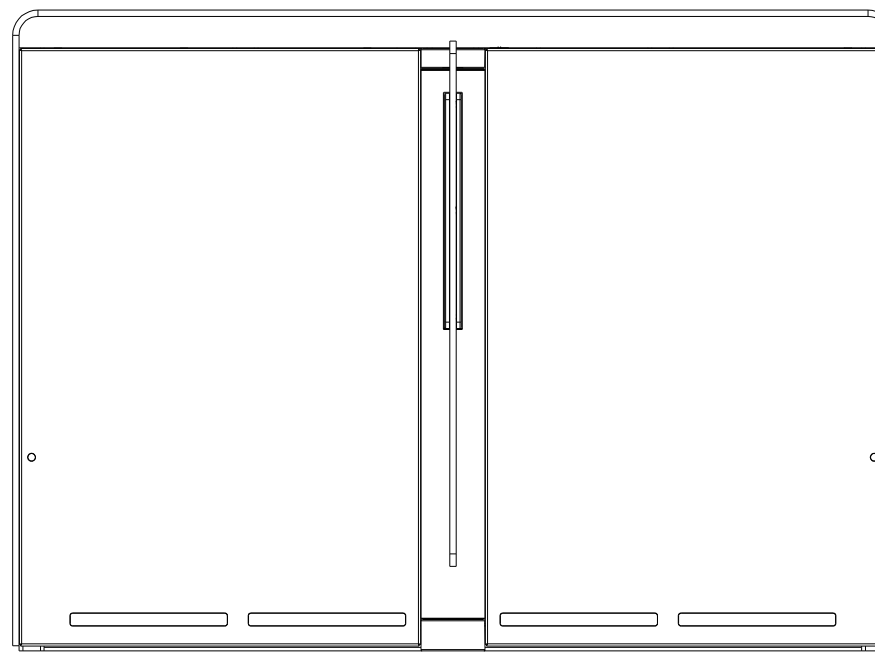

B

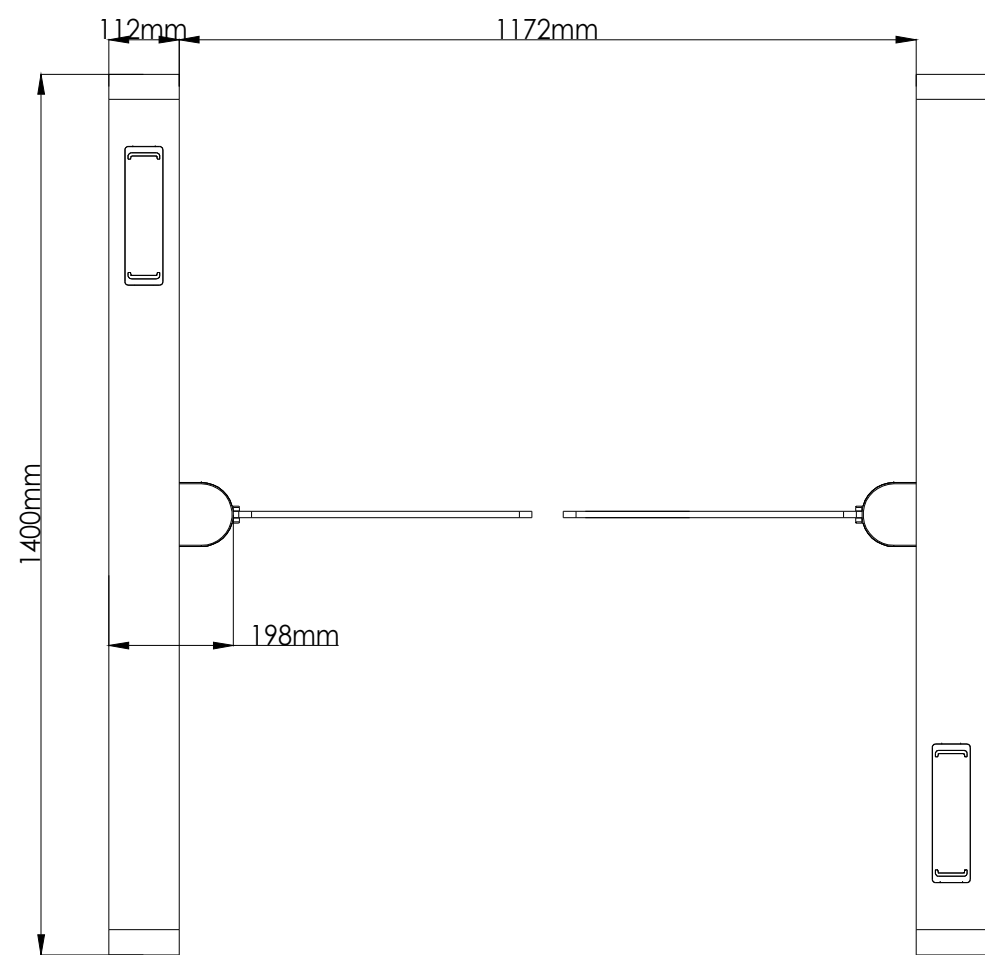

A

ASSA ABLOY

DRAWING NAME:
SG 400 BOXED 1400/ 1000-970

DRAWING NUMBER:
CD-1143-02

DRAWN F.C	DATE 4.06.2026	SIZE A4	REV Rev.002
--------------	-------------------	------------	----------------

D

C

B

A

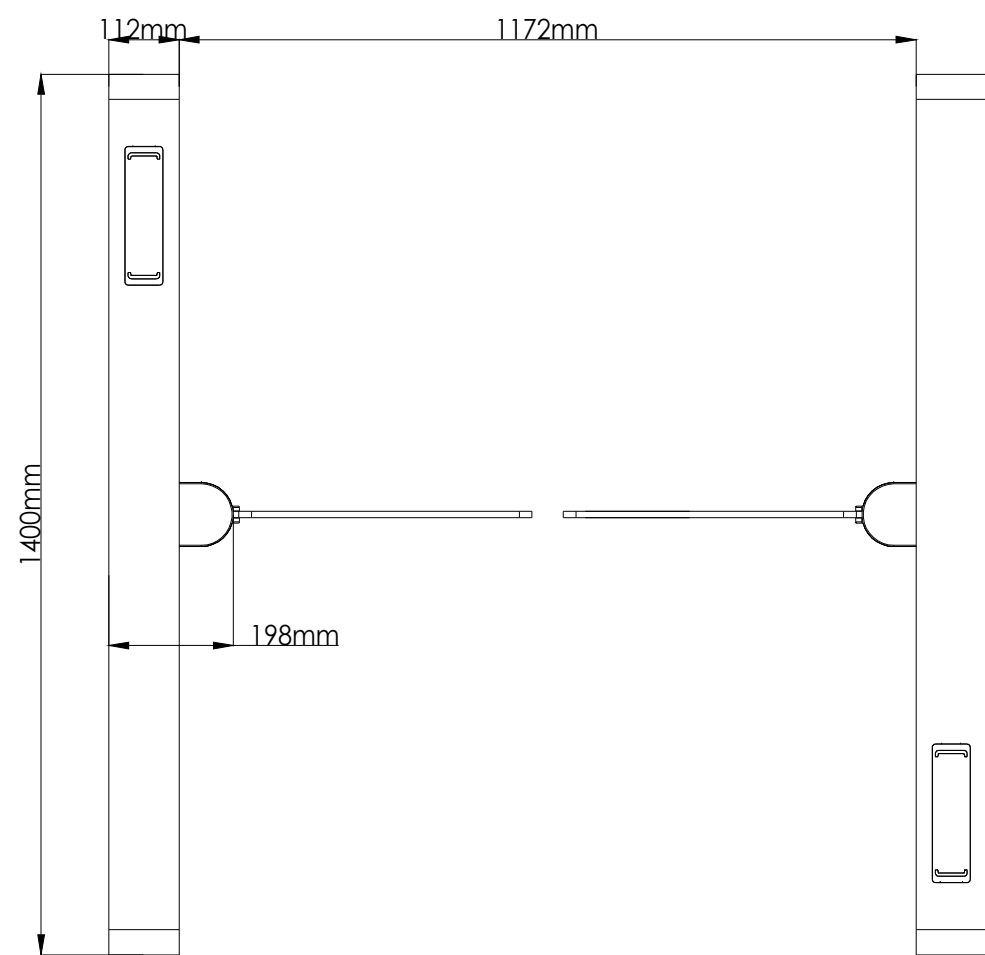
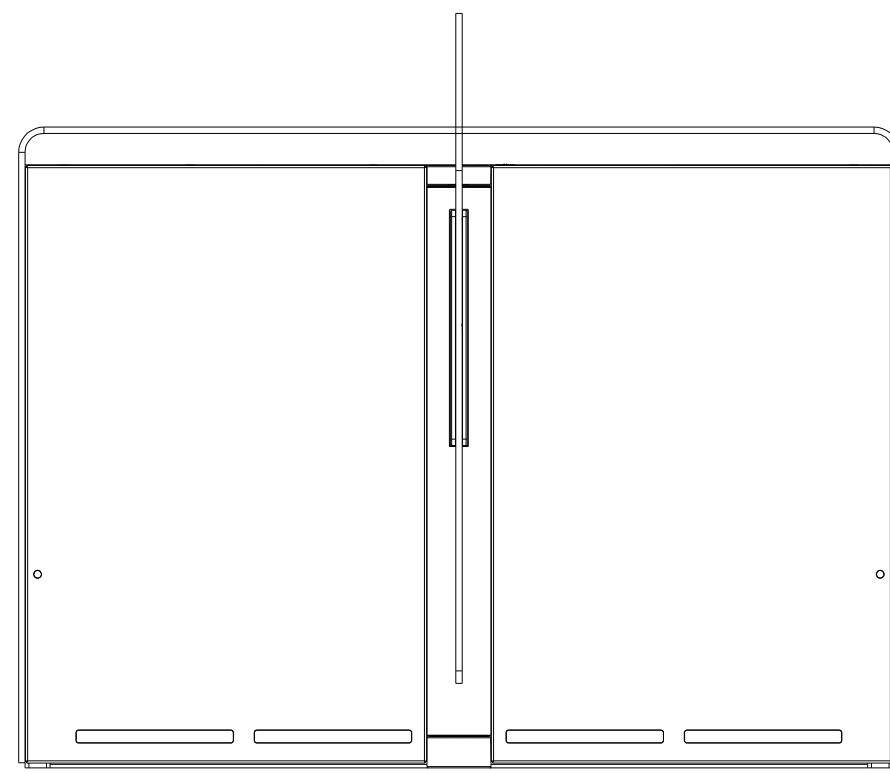
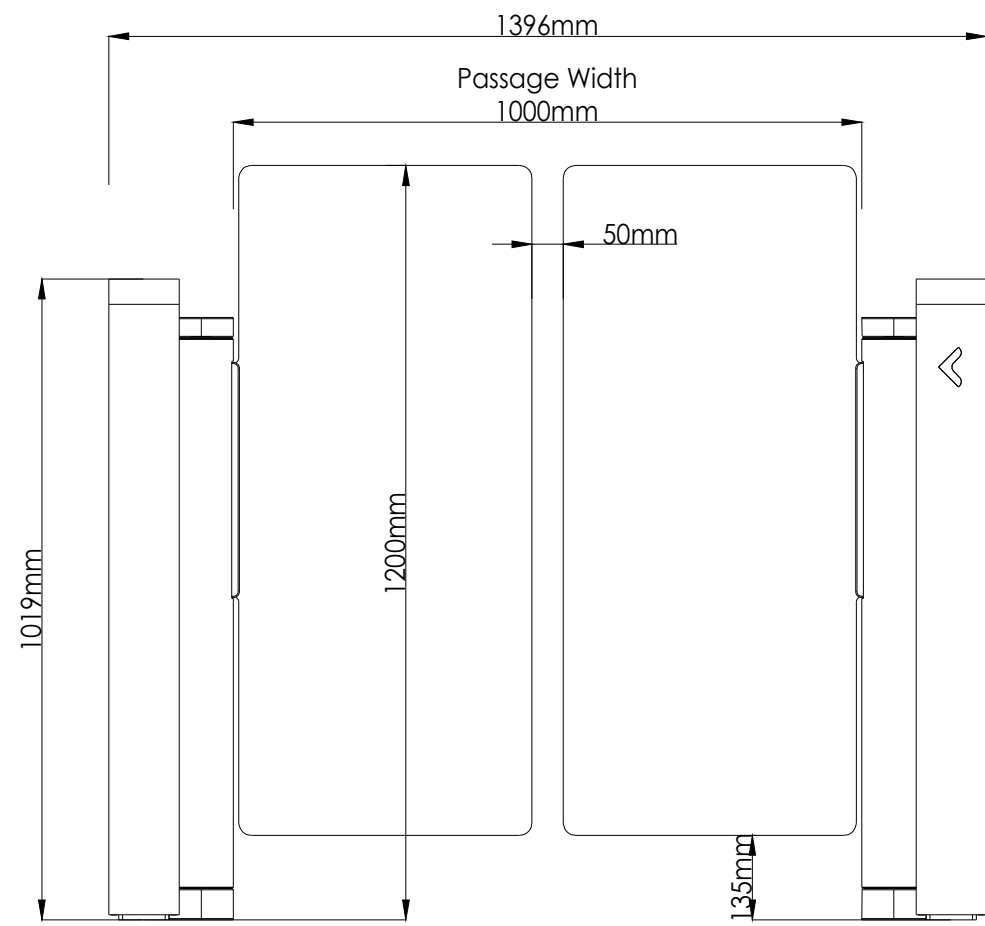

ASSA ABLOY

DRAWING NAME:
SG 400 BOXED 1400/ 1000-1200

DRAWING NUMBER:
CD-1144-02

DRAWN F.C	DATE 4.06.2026	SIZE A4	REV Rev.002
--------------	-------------------	------------	----------------

4

3

2

1

D

C

B

A

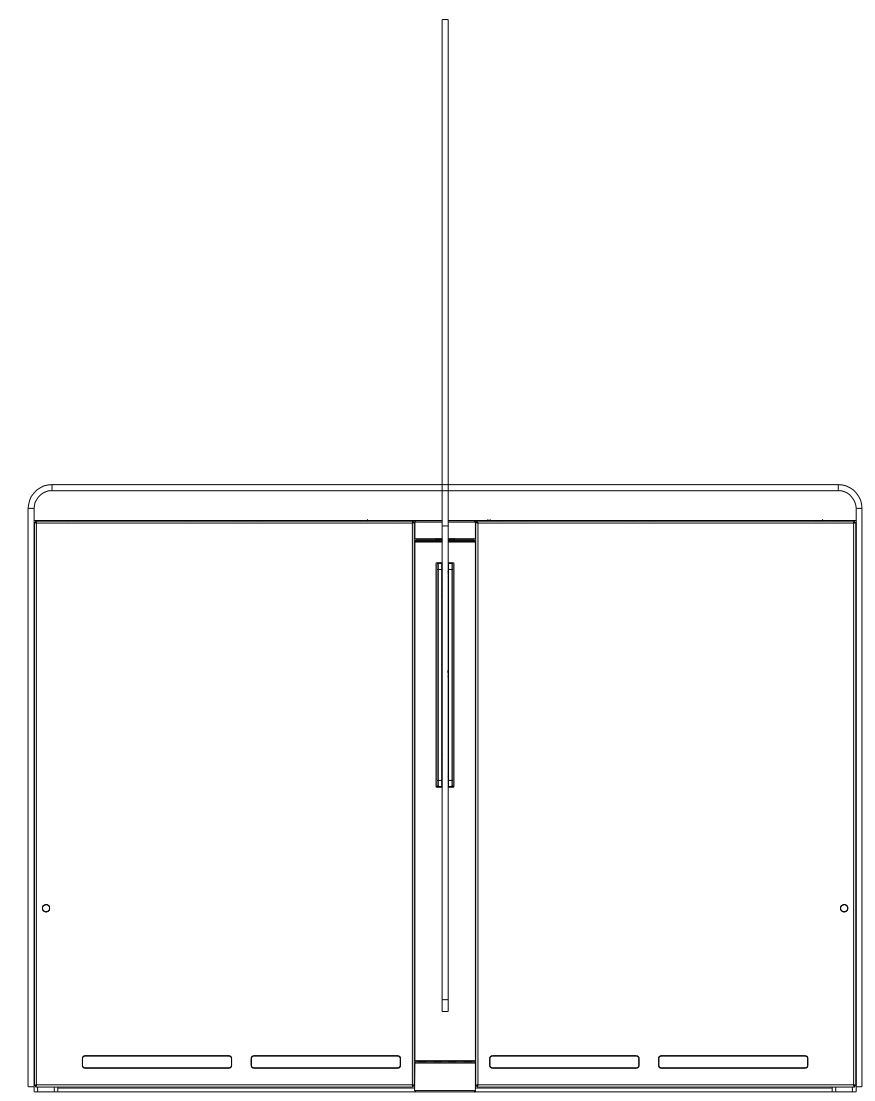
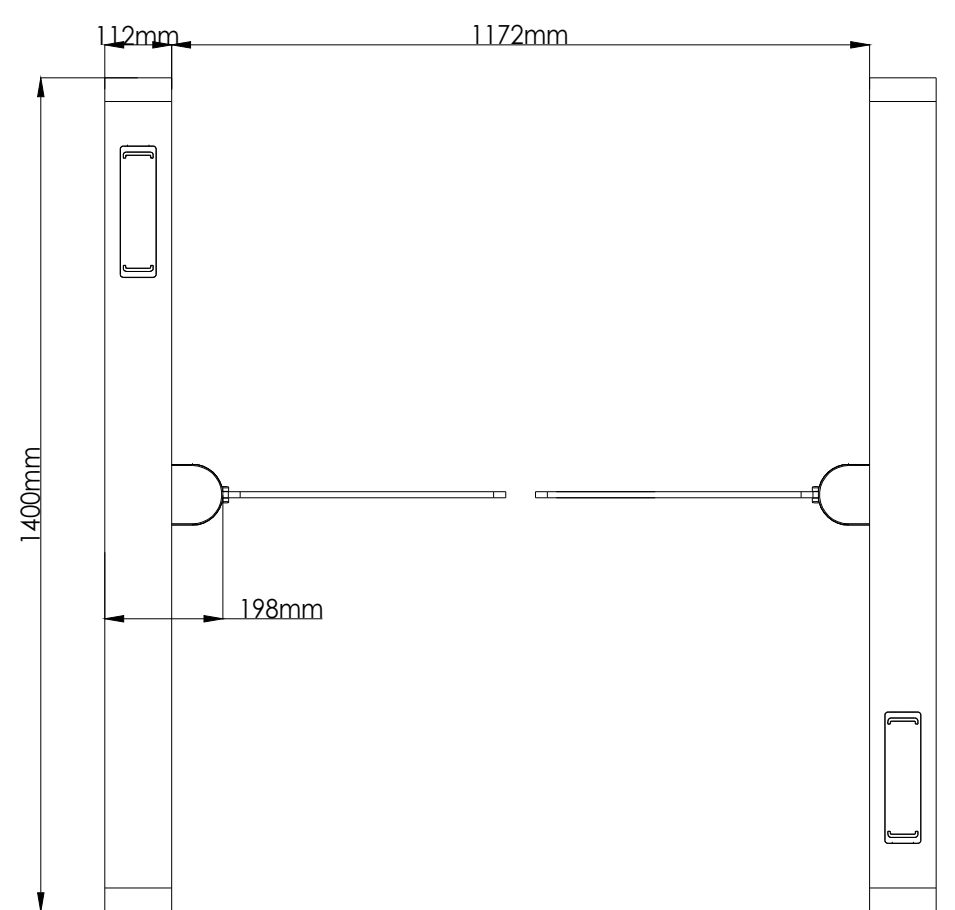
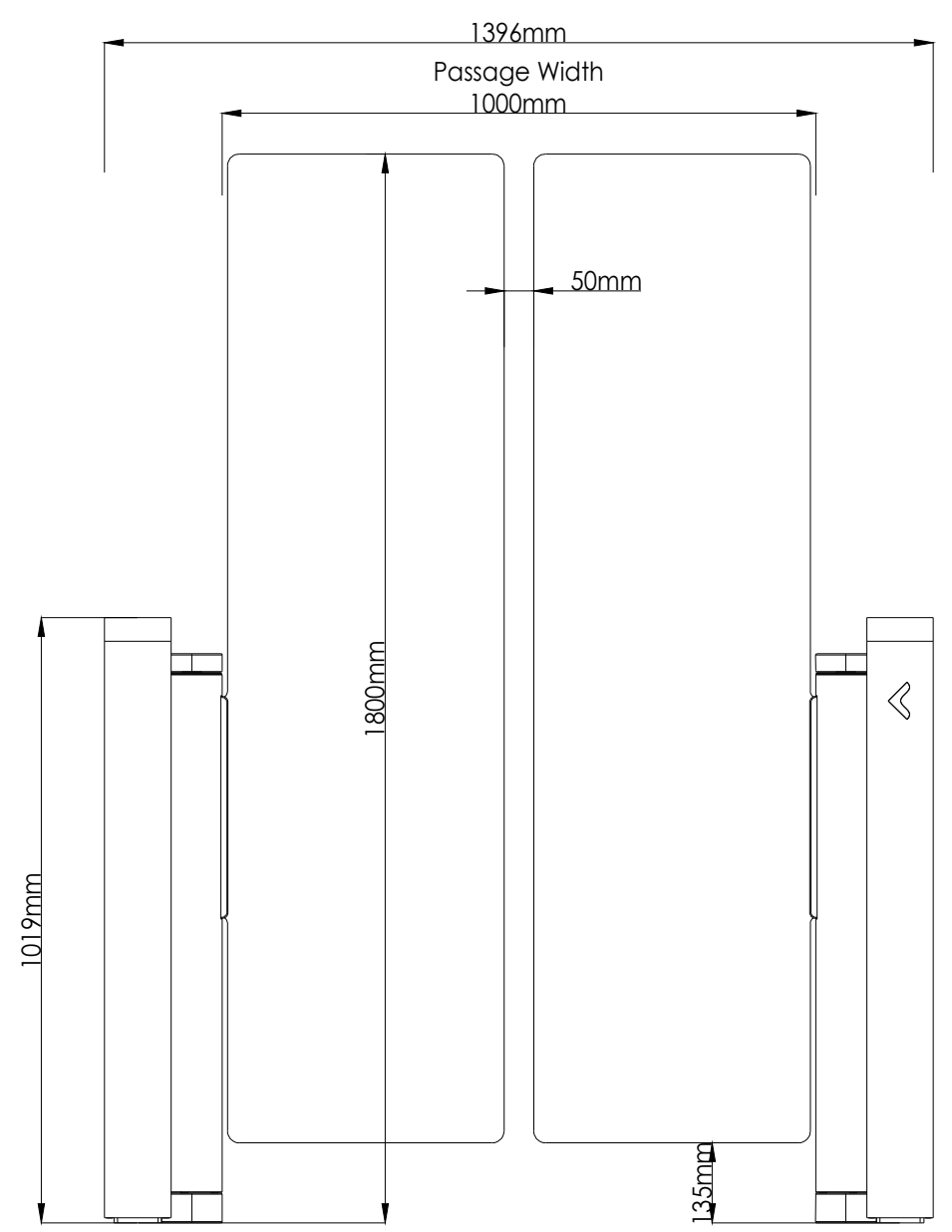

ASSA ABLOY			
DRAWING NAME: SG 400 BOXED 1400/ 1000-1800			
DRAWING NUMBER: CD-1145-02			
DRAWN F.C	DATE 4.06.2026	SIZE A4	REV Rev.002
SHEET: 1 OF 1			

4

3

2

1

D

C

B

A

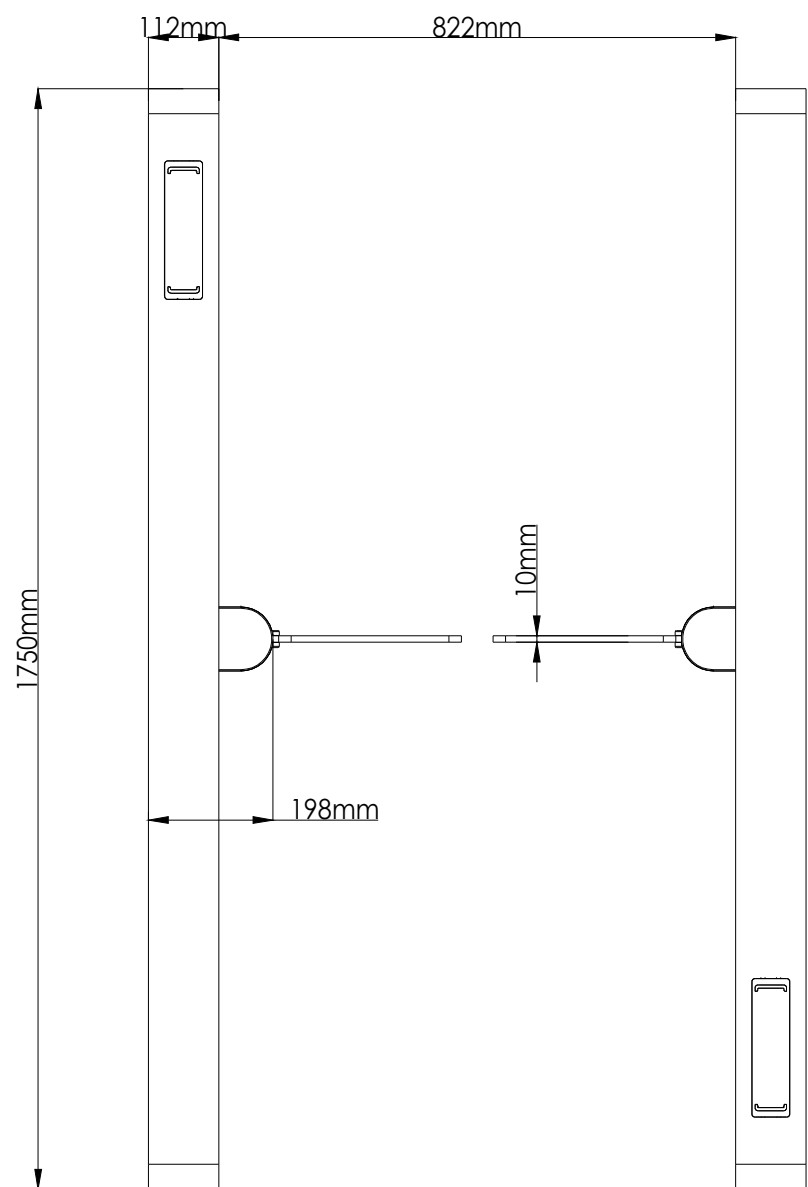
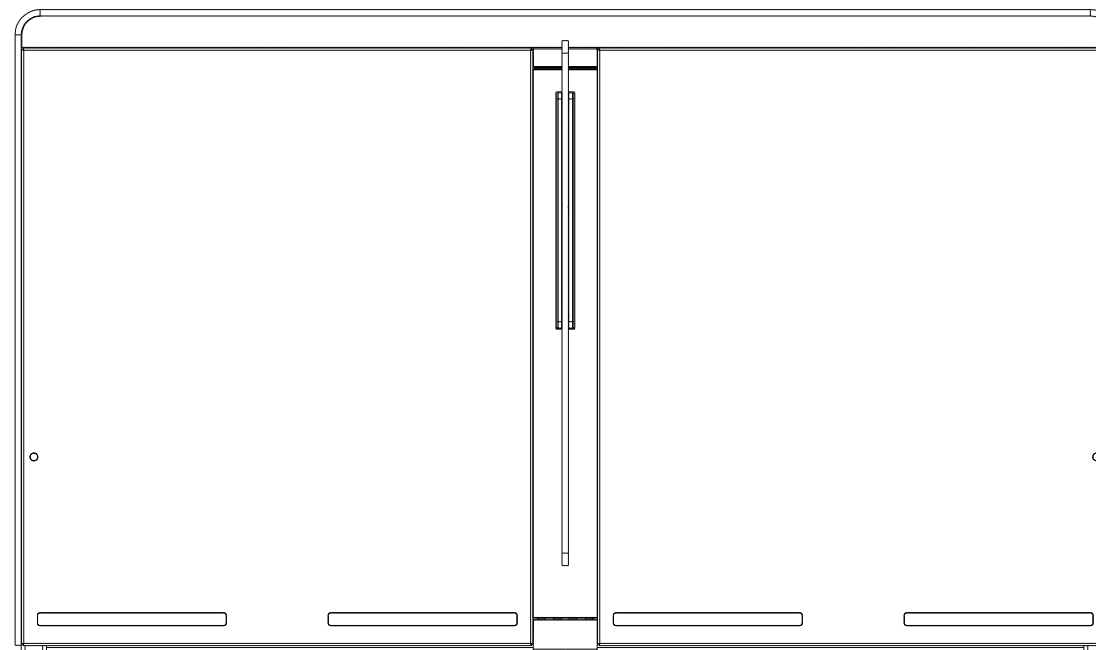
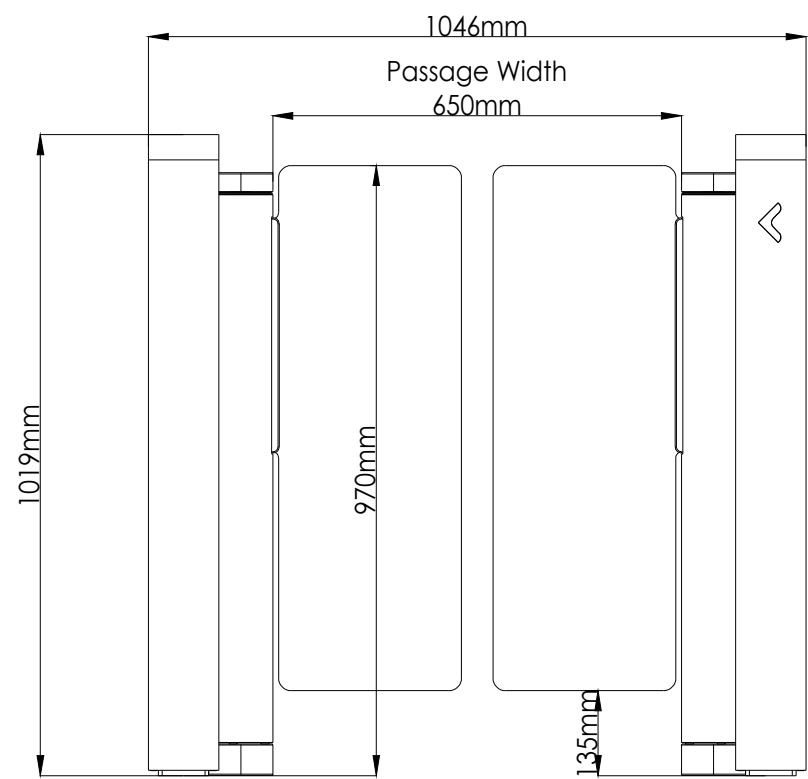

ASSA ABLOY

DRAWING NAME:
SG 400 BOXED 1750/ 650-970

DRAWING NUMBER:
CD-1146-02

DRAWN F.C	DATE 4.06.2026	SIZE A4	REV Rev.002
--------------	-------------------	------------	----------------

SHEET: 1 OF 1

4

3

2

1

D

C

B

A

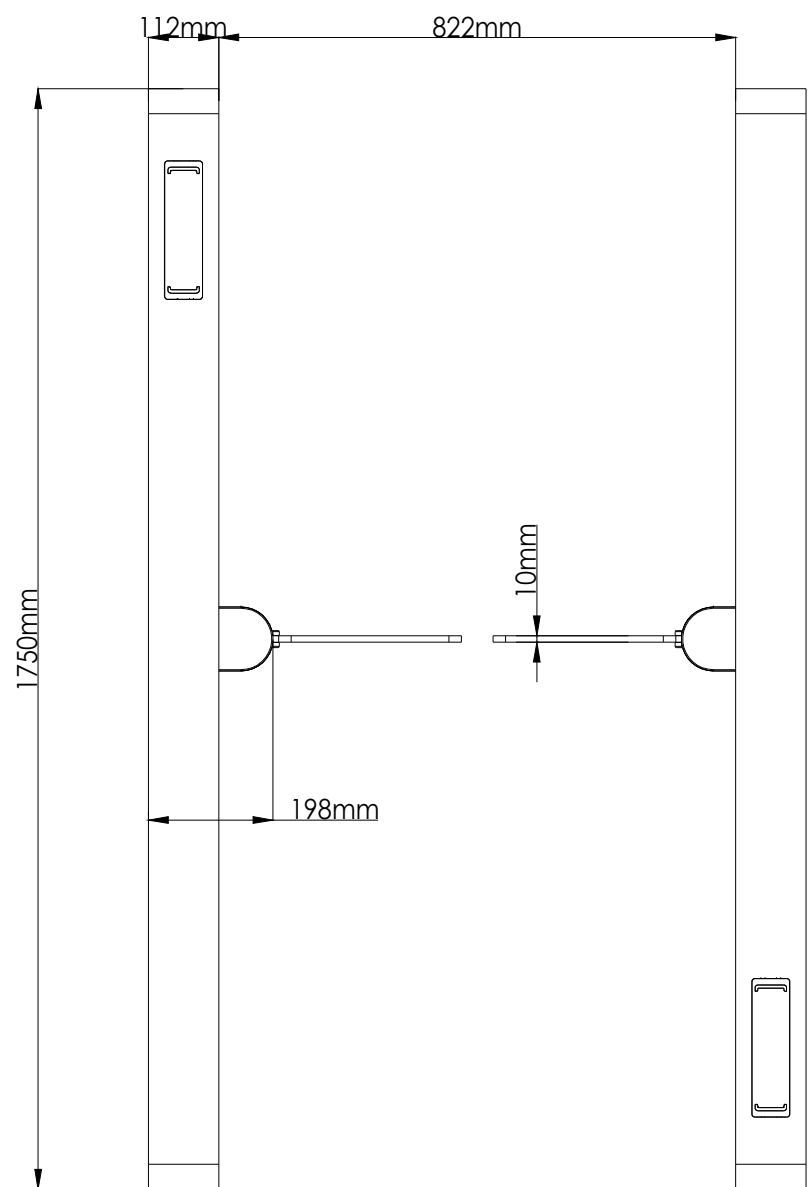
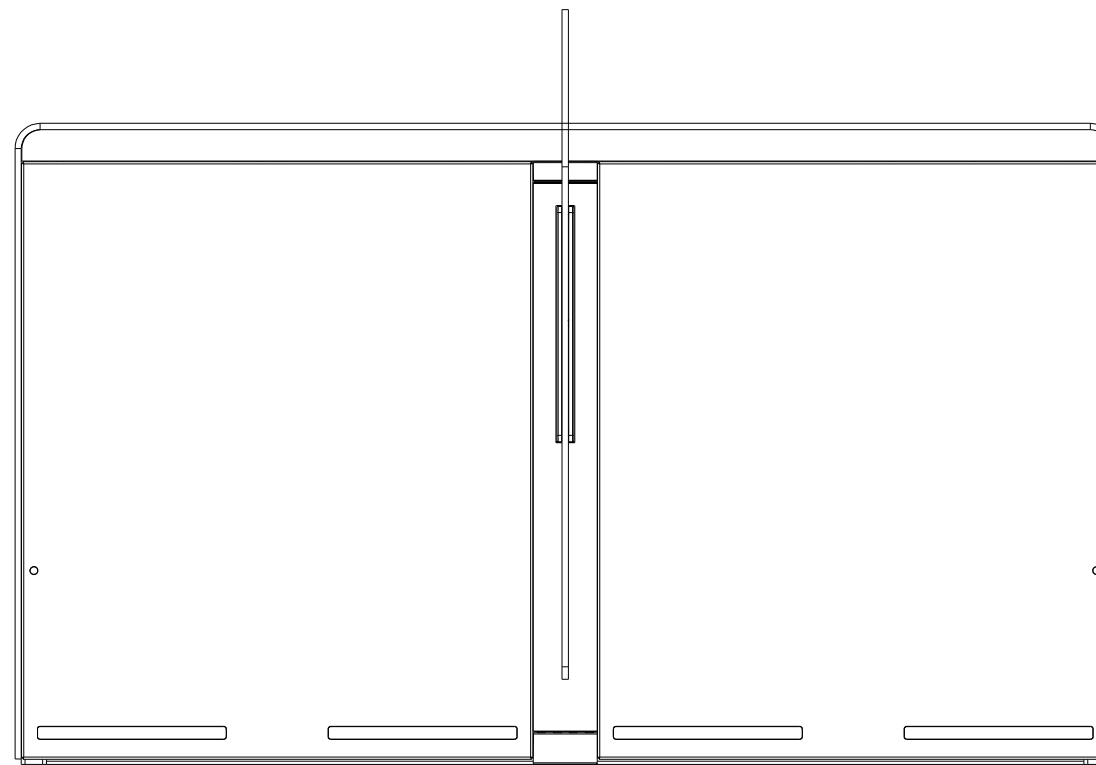
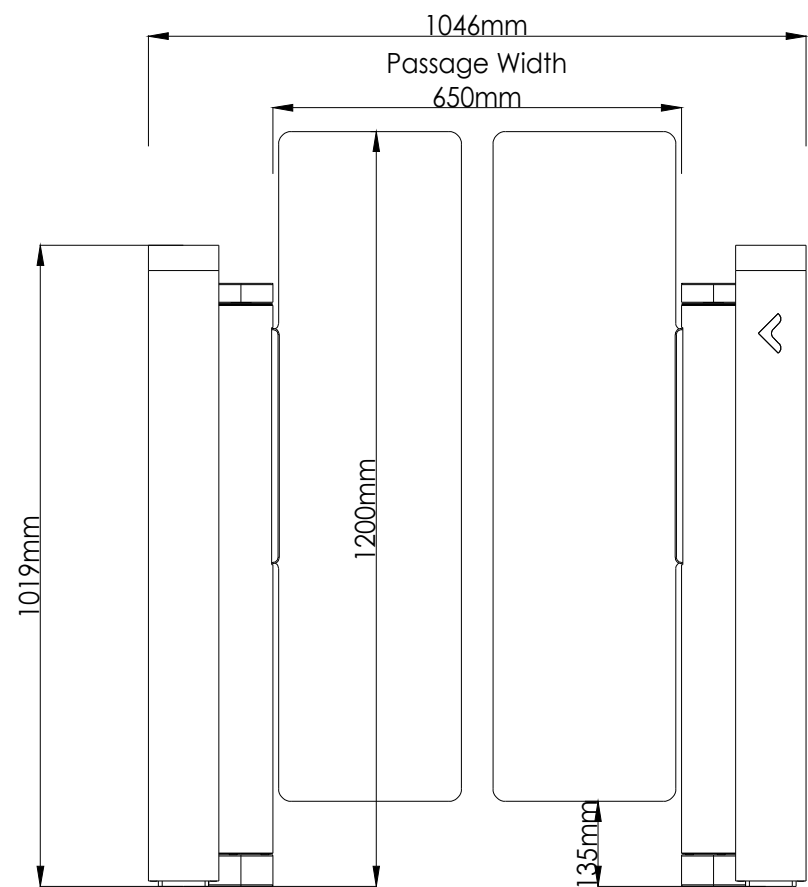

ASSA ABLOY

DRAWING NAME:
SG 400 BOXED 1750/ 650-1200

DRAWING NUMBER:
CD-1147-02

DRAWN	DATE	SIZE	REV
F.C	4.06.2026	A4	Rev.002

4

3

2

1

D

C

B

A

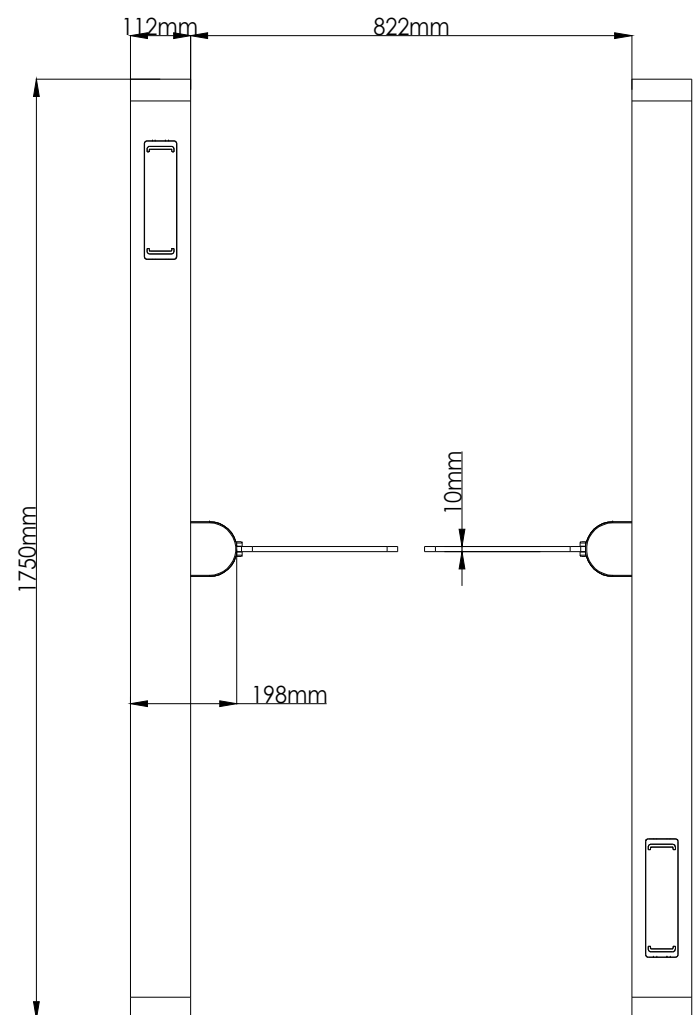
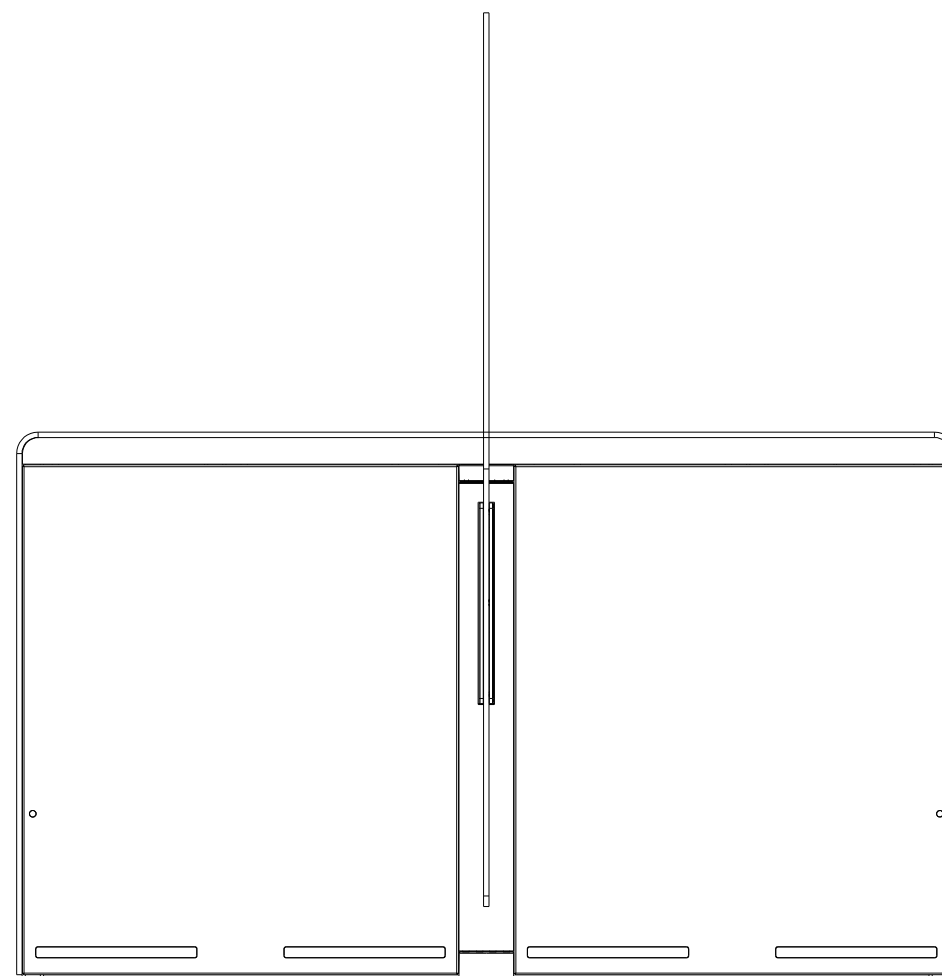
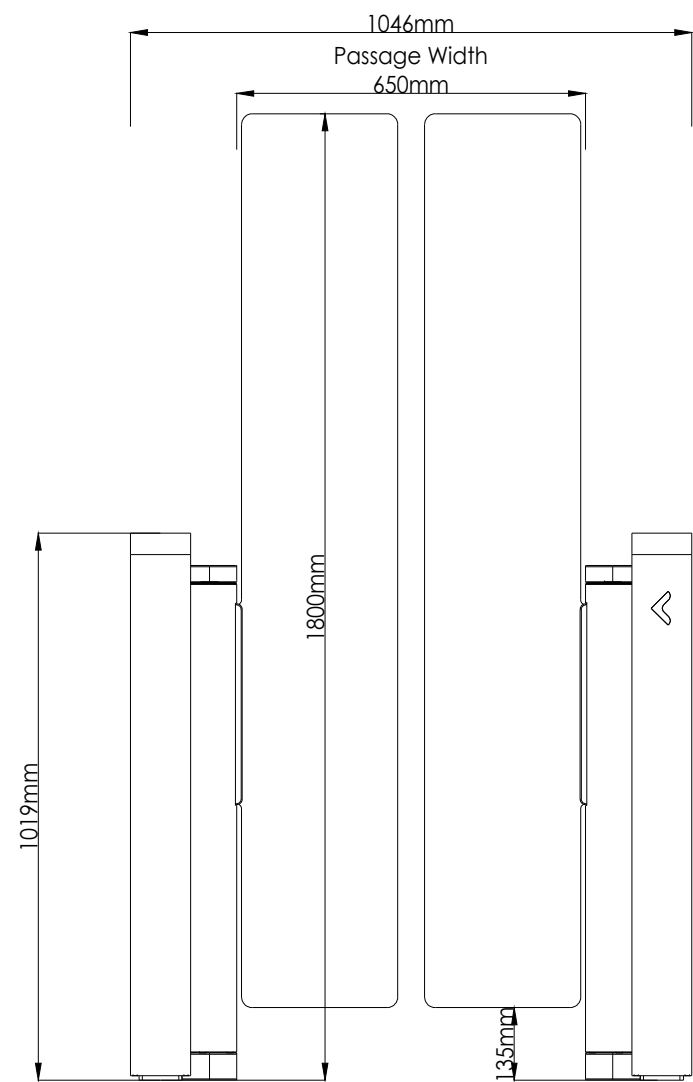

ASSA ABLOY

DRAWING NAME:
SG 400 BOXED 1750/ 650-1800

DRAWING NUMBER:
CD-1148-02

DRAWN	DATE	SIZE	REV
F.C	4.06.2026	A4	Rev.002

SHEET: 1 OF 1

4

3

2

1

D

C

B

A

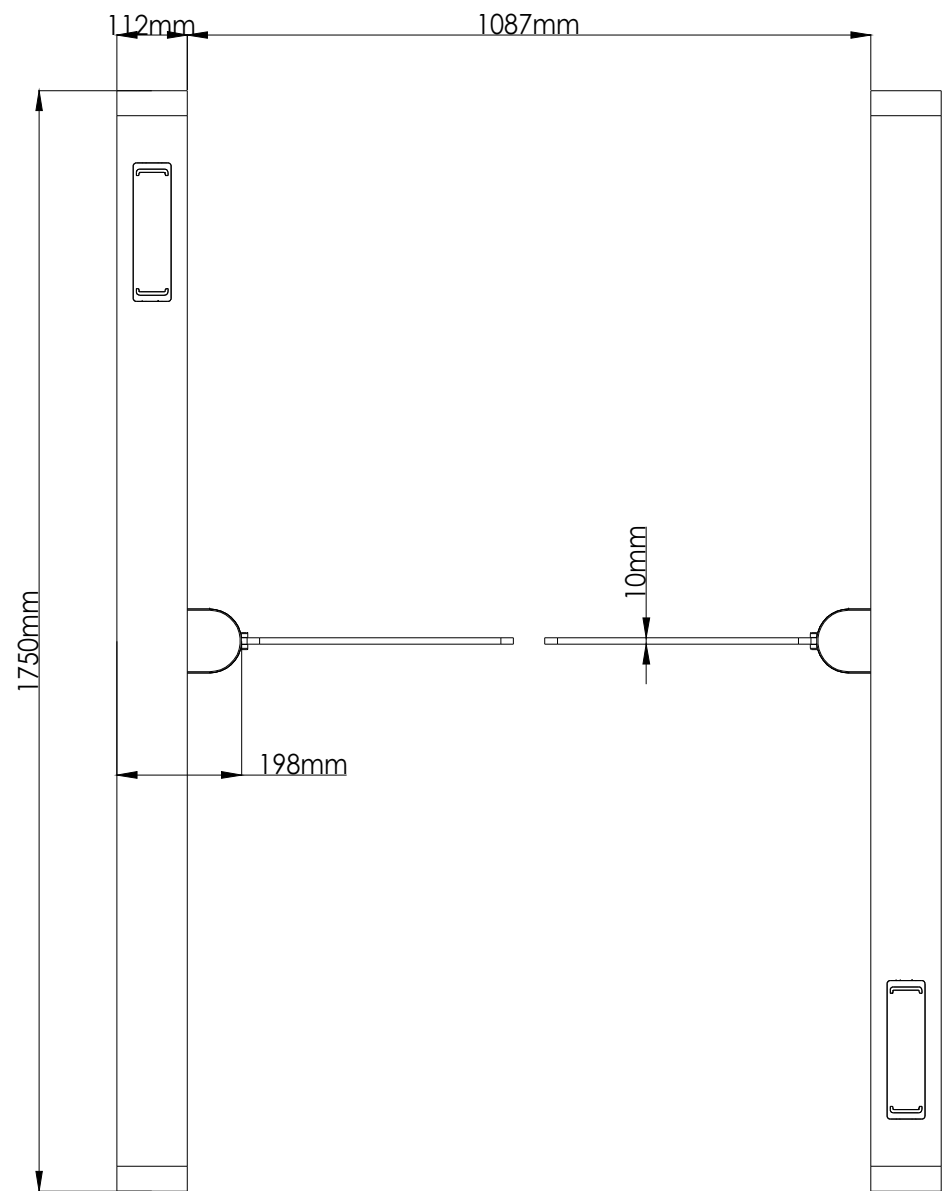
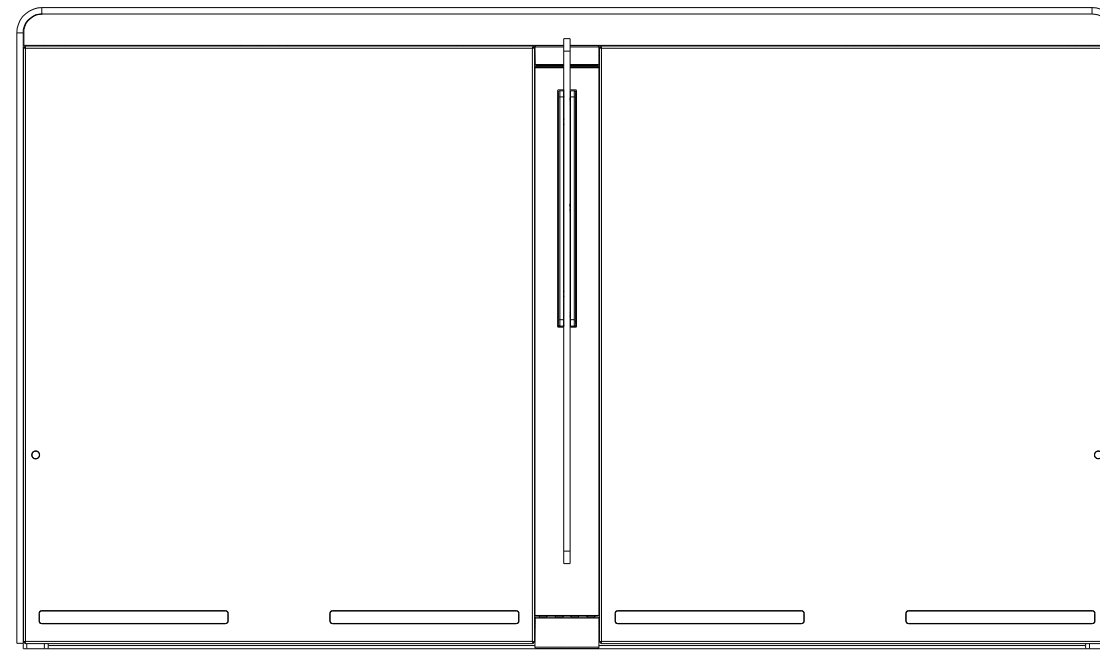
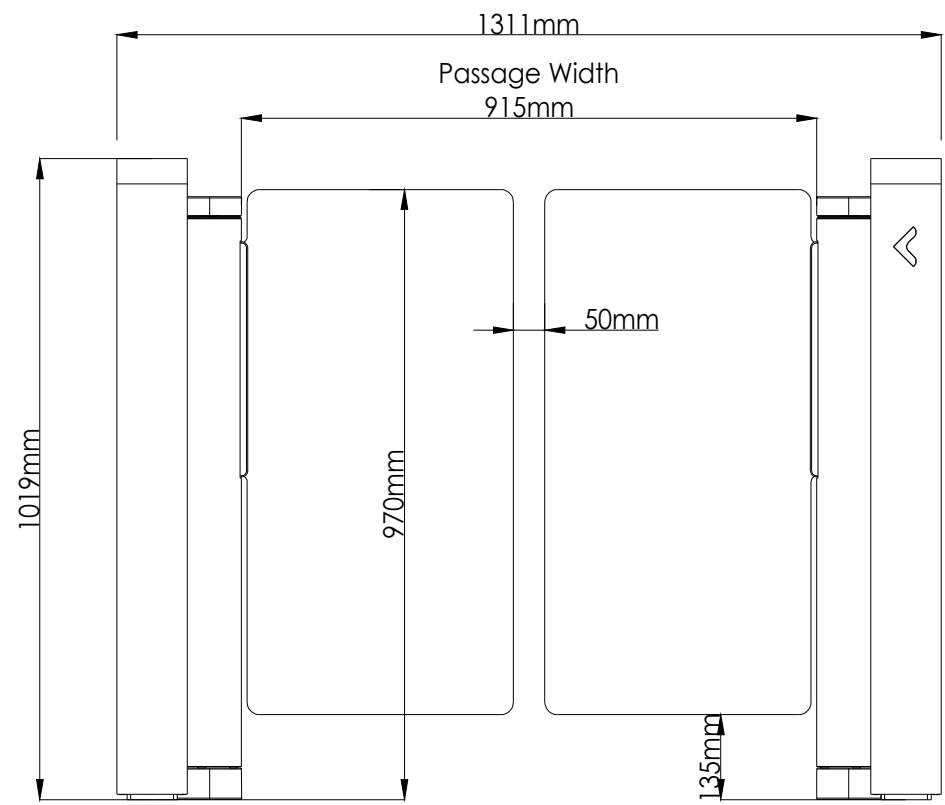

ASSA ABLOY

DRAWING NAME:
SG 400 BOXED 1750/ 915-970

DRAWING NUMBER:
CD-1149-02

DRAWN F.C	DATE 4.06.2026	SIZE A4	REV Rev.002
--------------	-------------------	------------	----------------

4

3

2

1

D

C

B

A

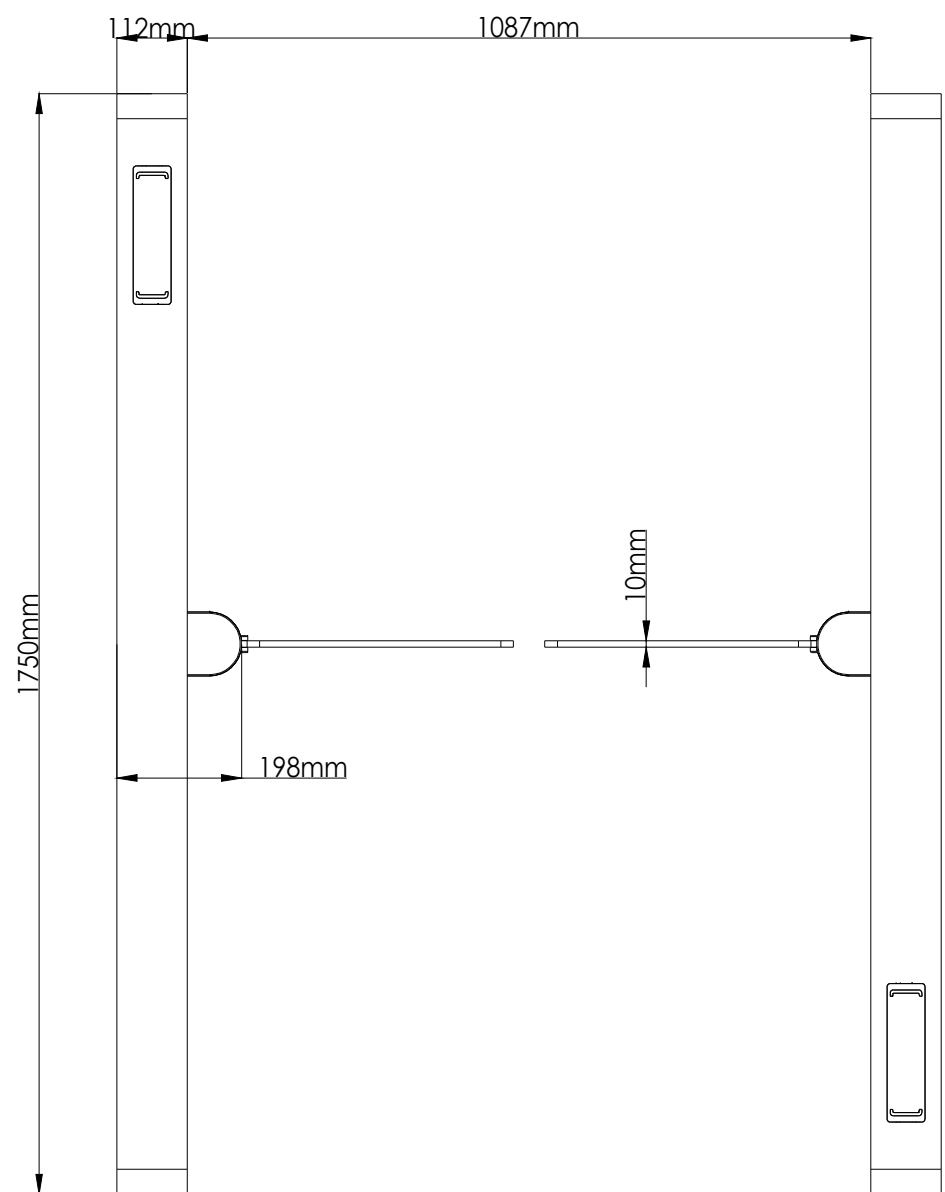
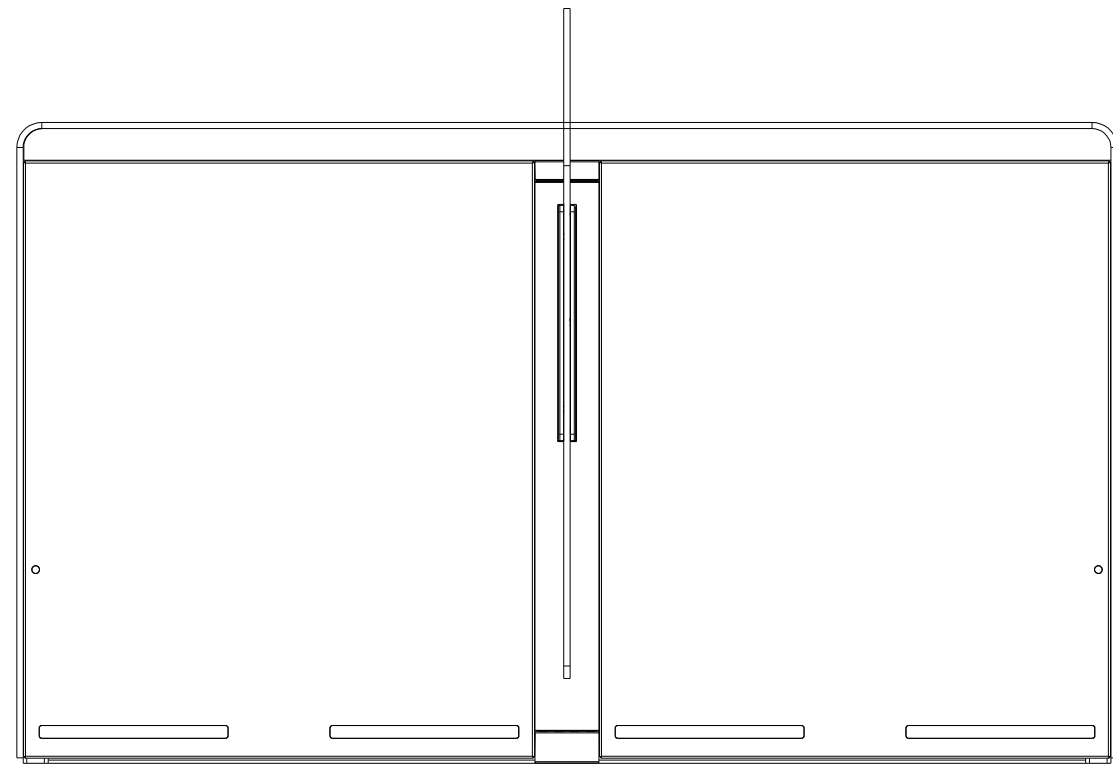
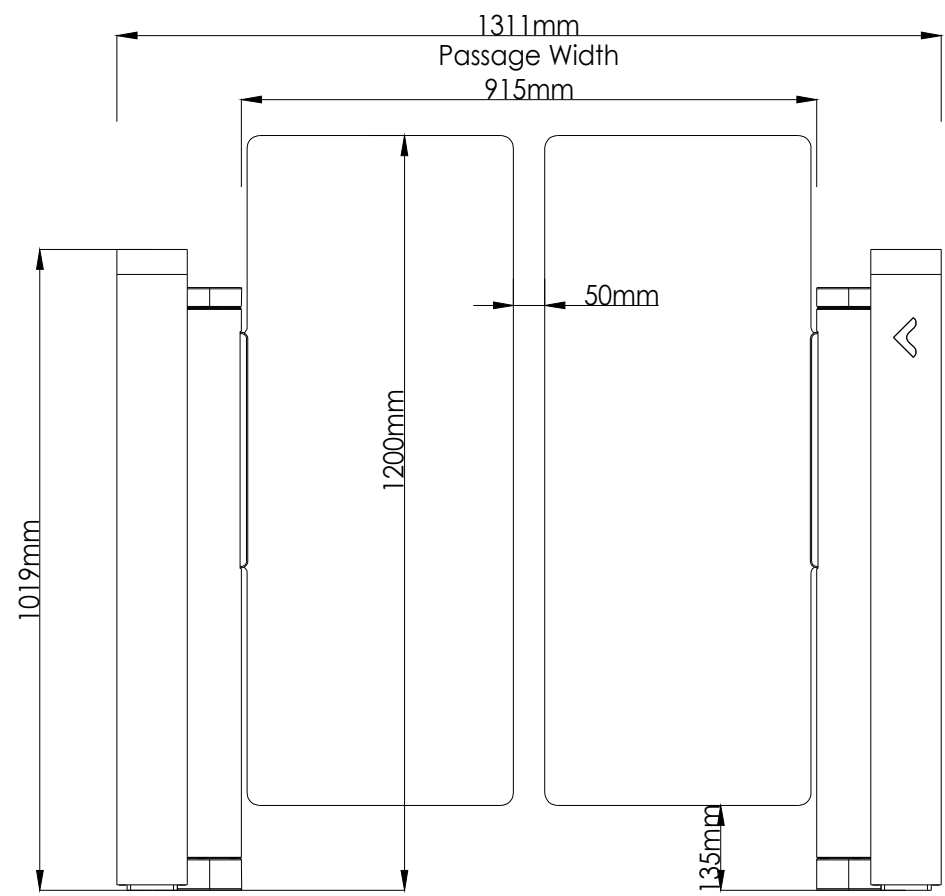

ASSA ABLOY

DRAWING NAME:
SG 400 BOXED 1750/ 915-1200

DRAWING NUMBER:
CD-1150-02

DRAWN F.C	DATE 4.06.2026	SIZE A4	REV Rev.002
--------------	-------------------	------------	----------------

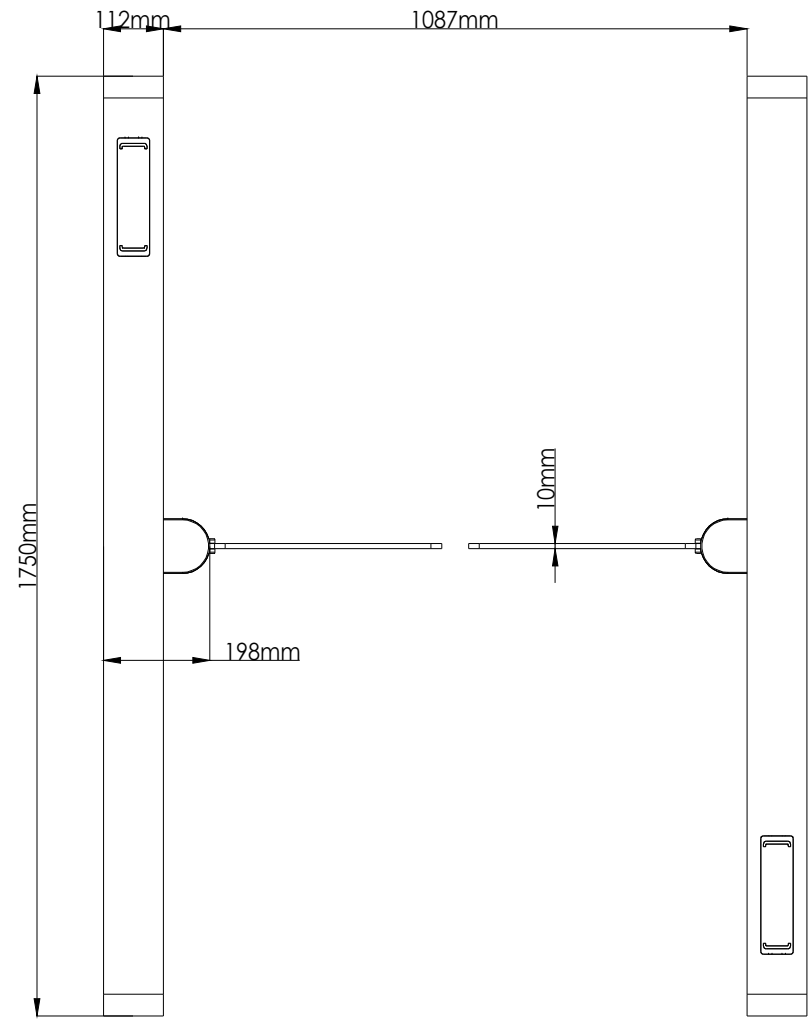
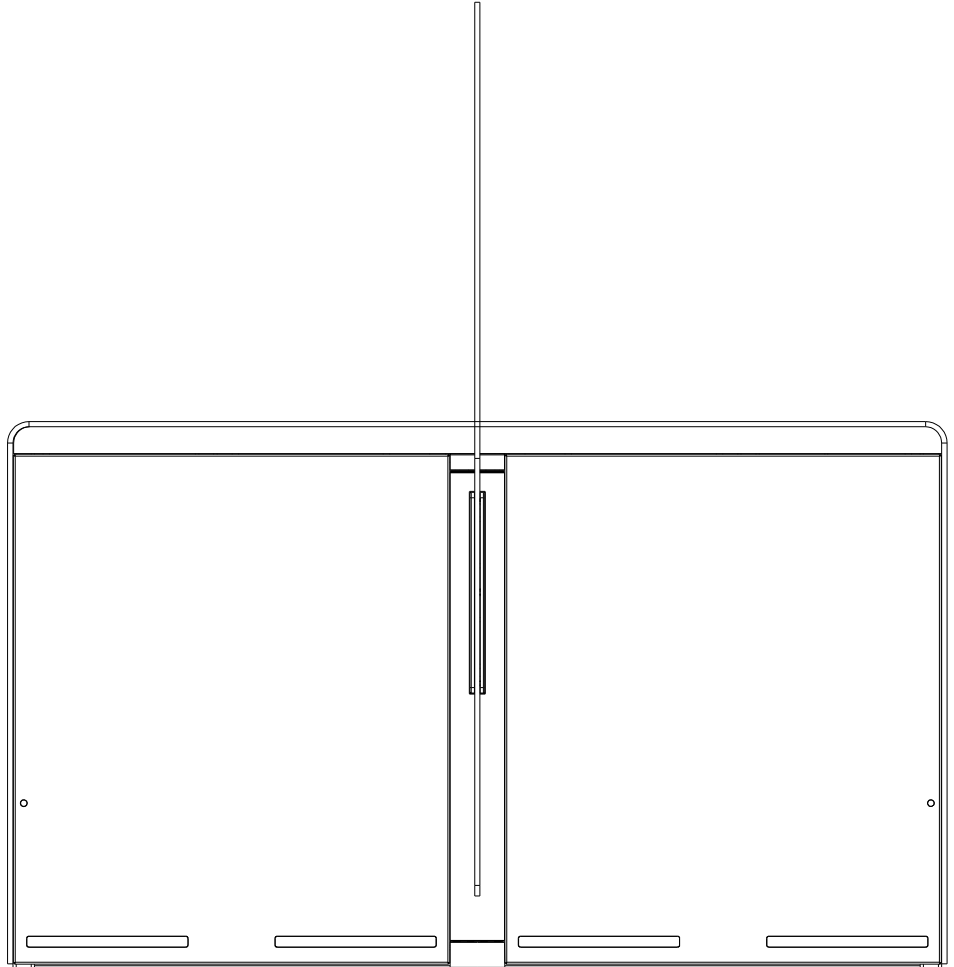
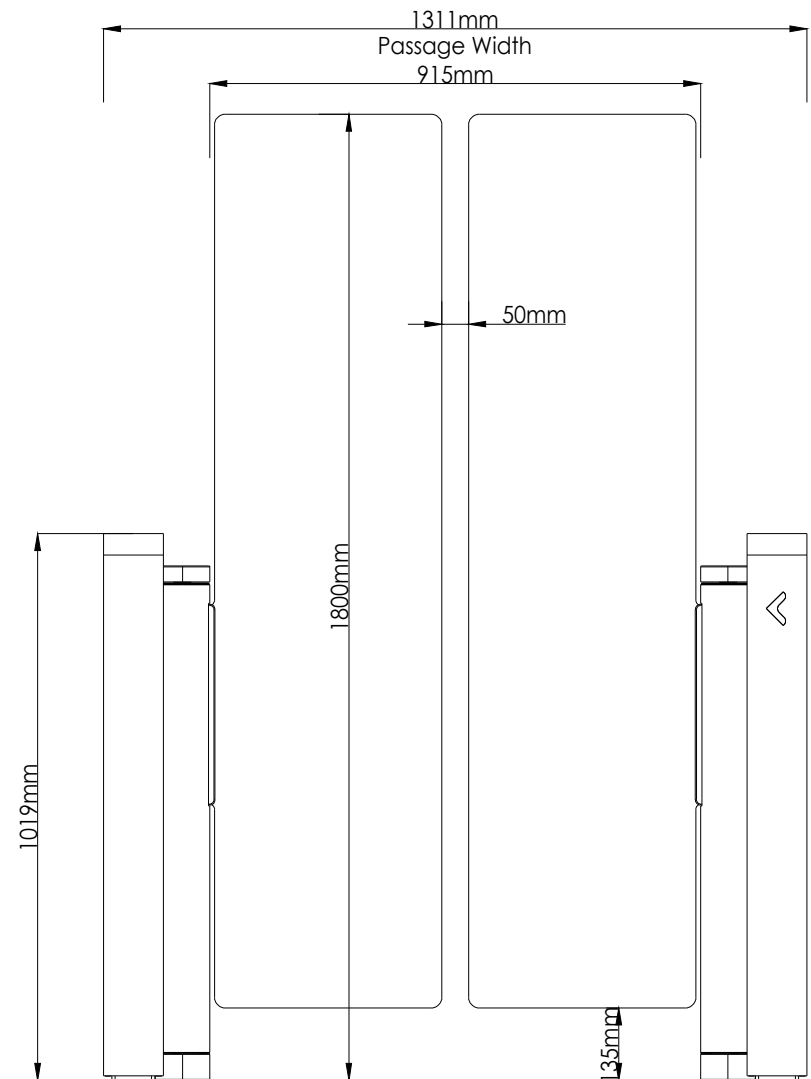

D

C

B

A

ASSA ABLOY

DRAWING NAME:
SG 400 BOXED 1750/ 915-1800

DRAWING NUMBER:
CD-1151-02

DRAWN	DATE	SIZE	REV
F.C	4.06.2026	A4	Rev.002

SHEET: 1 OF 1

4

3

2

1

D

C

B

A

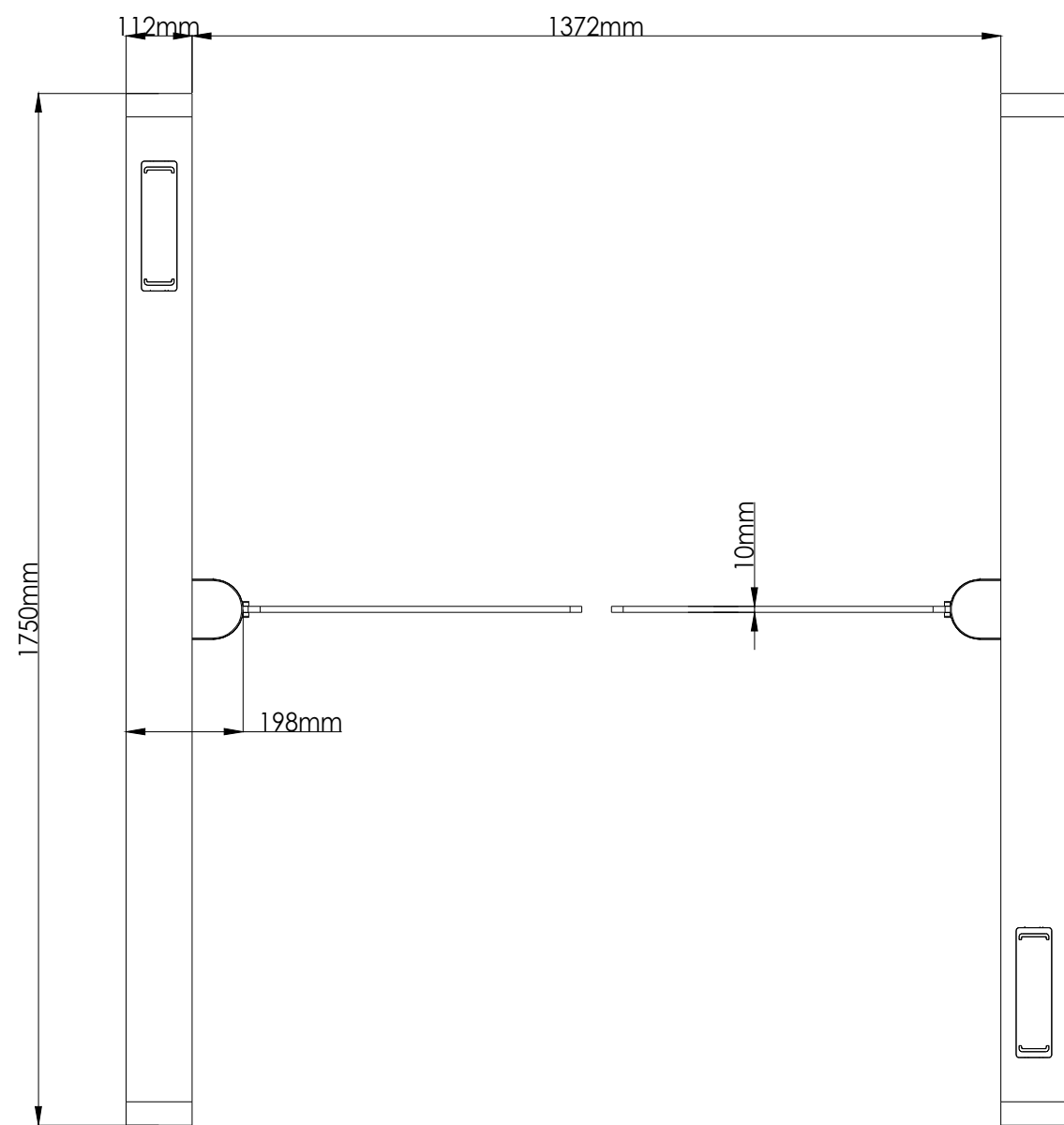
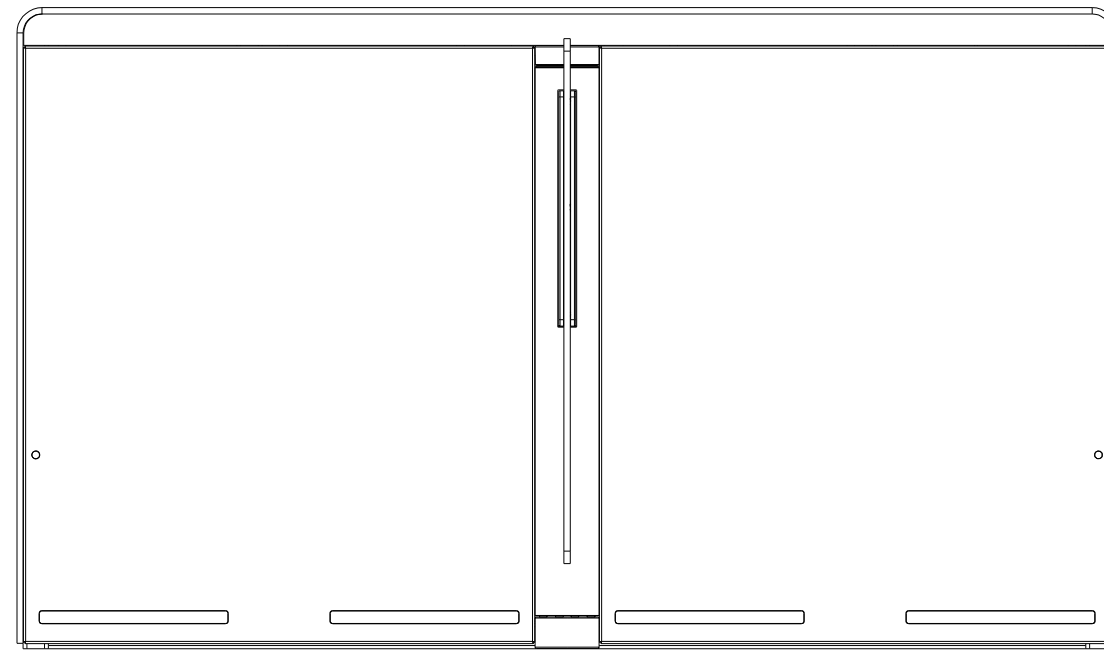
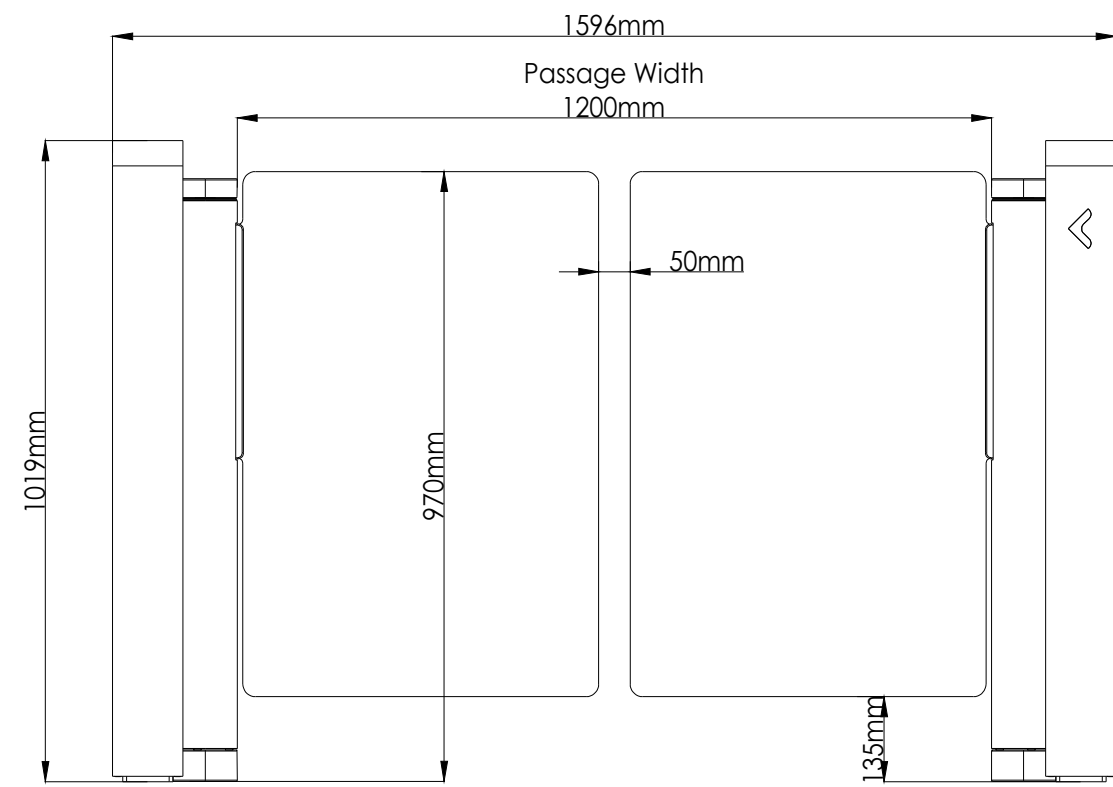

ASSA ABLOY

DRAWING NAME:
SG 400 BOXED 1750/ 1200-970

DRAWING NUMBER:
CD-1152-02

DRAWN F.C	DATE 4.06.2026	SIZE A4	REV Rev.002
--------------	-------------------	------------	----------------

SHEET: 1 OF 1

4

3

2

1

D

C

B

A

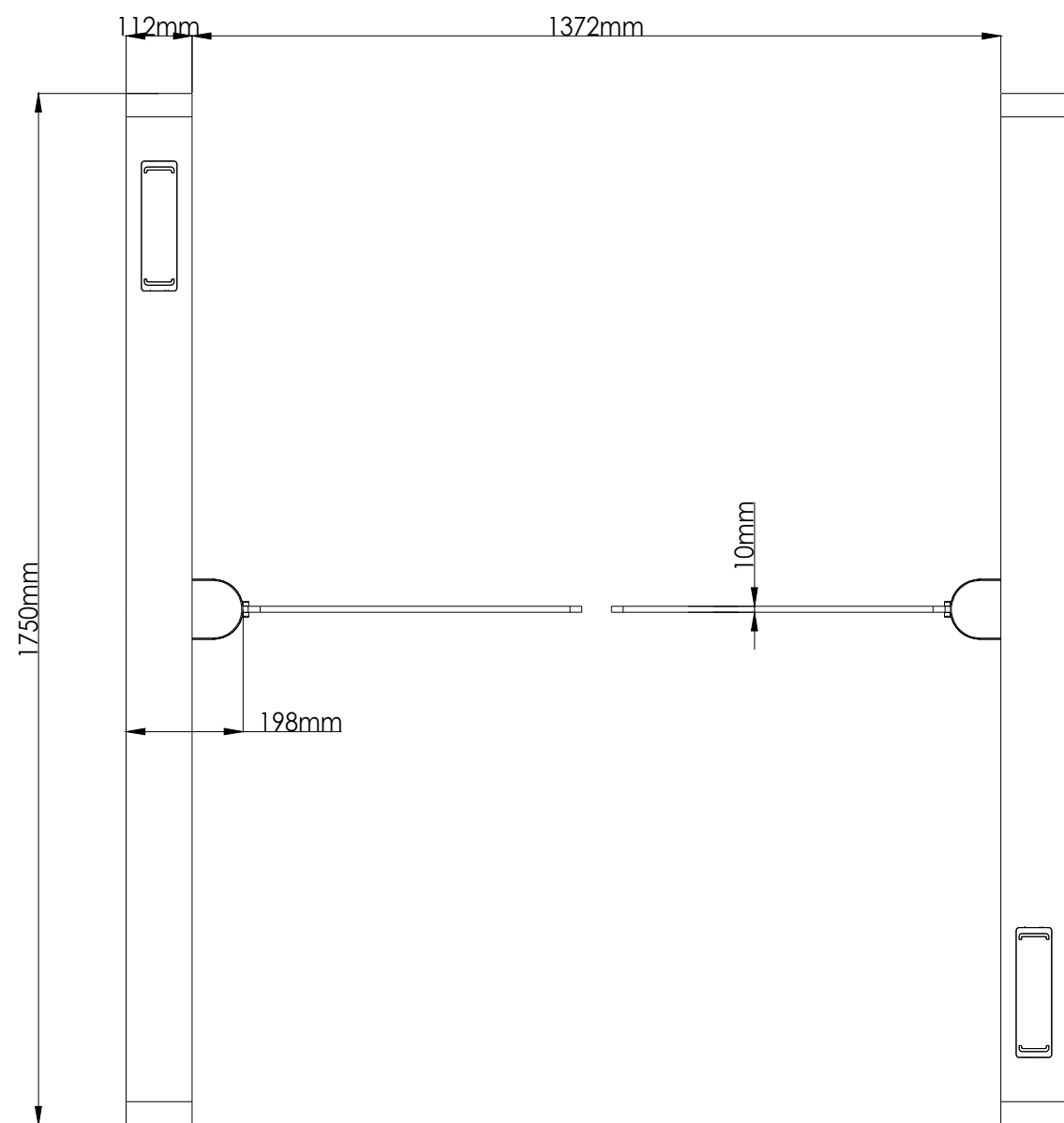
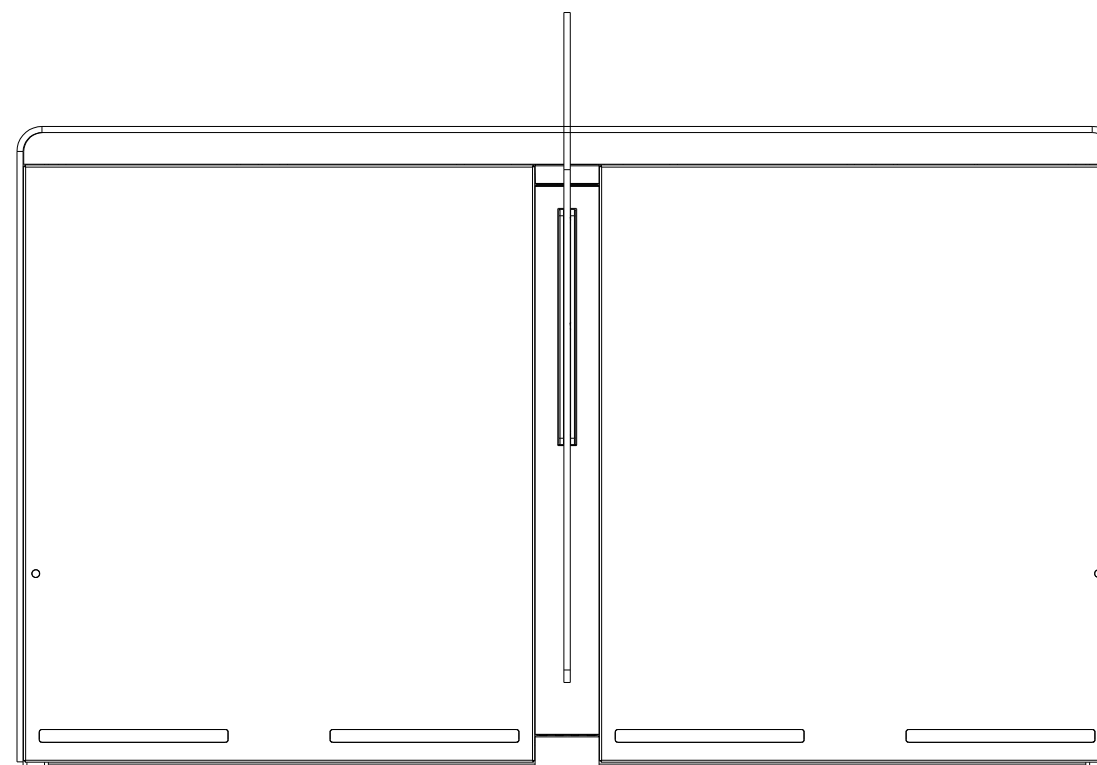
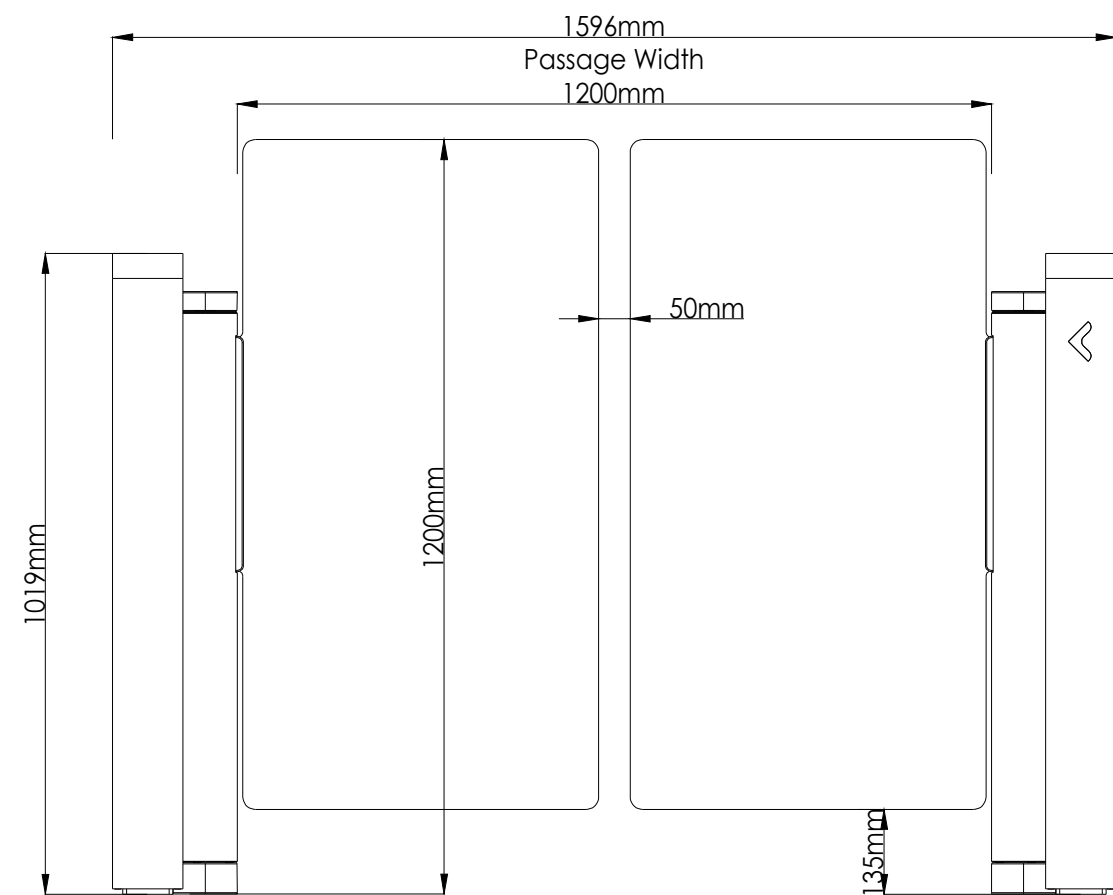

ASSA ABLOY

DRAWING NAME:
SG 400 BOXED 1750/ 1200-1200

DRAWING NUMBER:
CD-1153-02

DRAWN	DATE	SIZE	REV
F.C	4.06.2026	A4	Rev.002

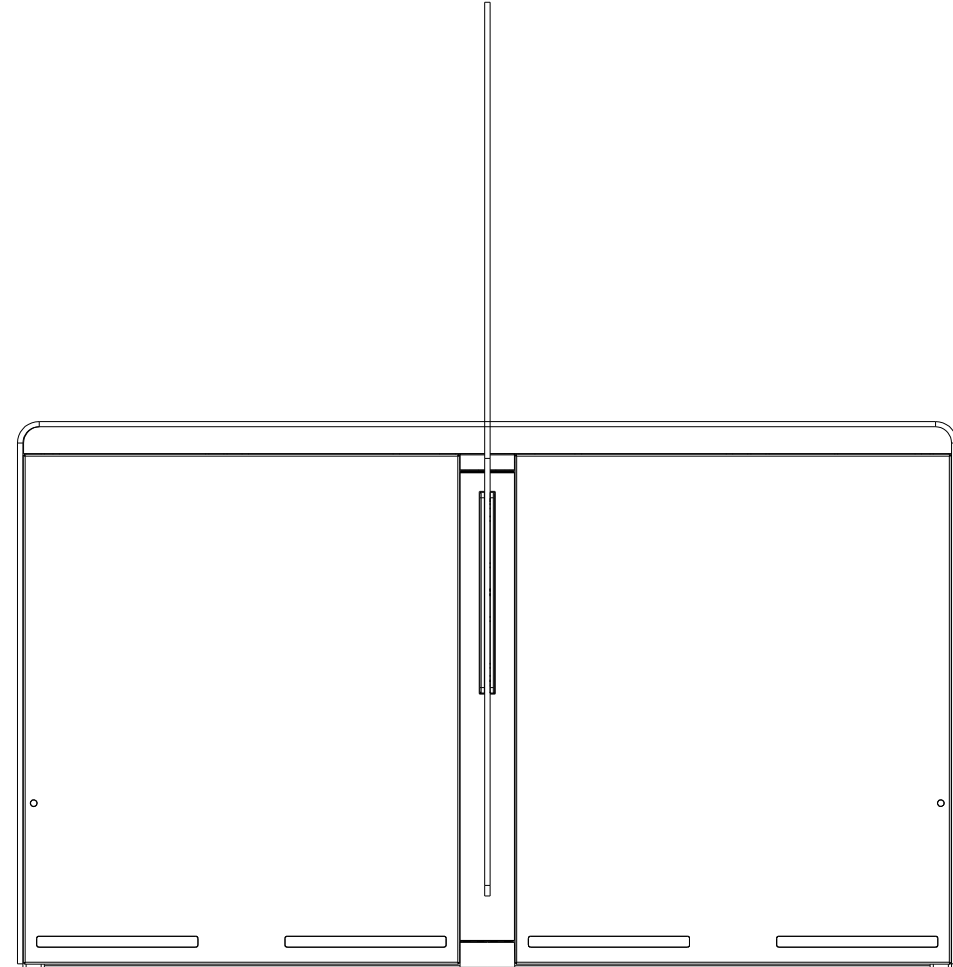
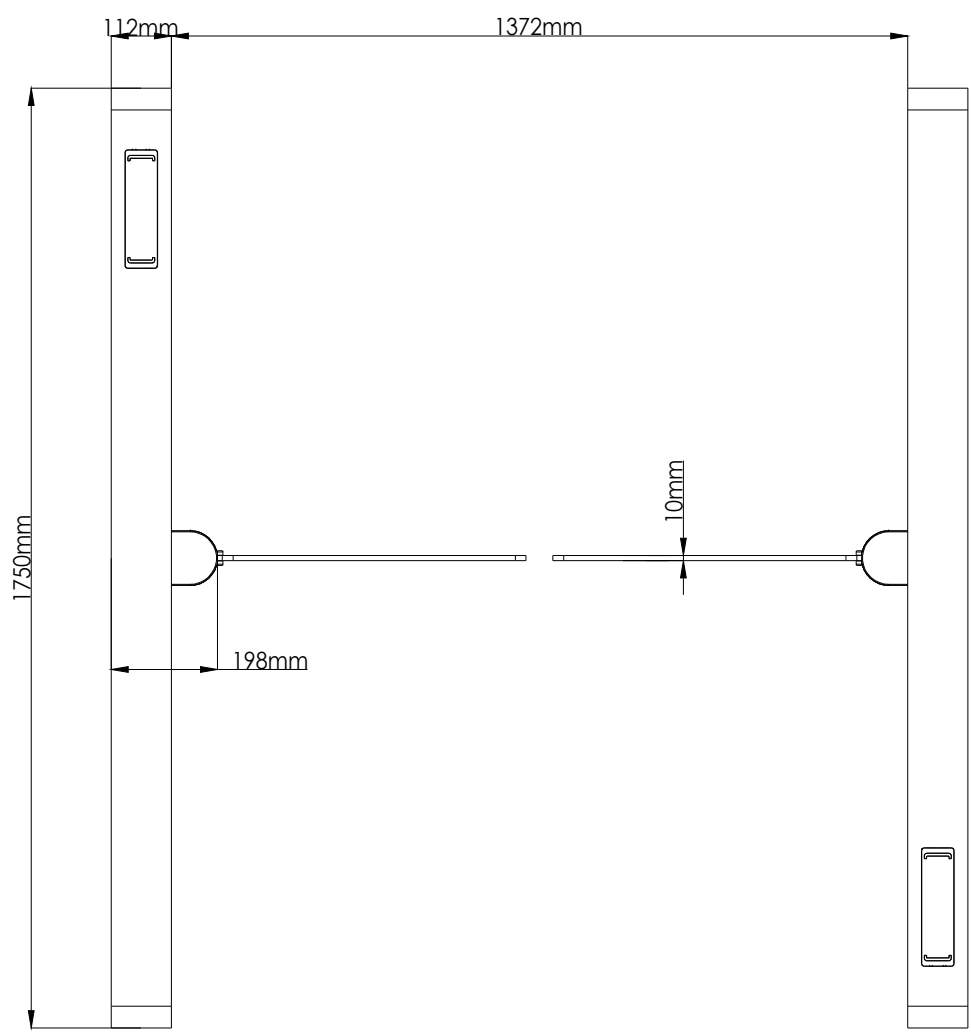
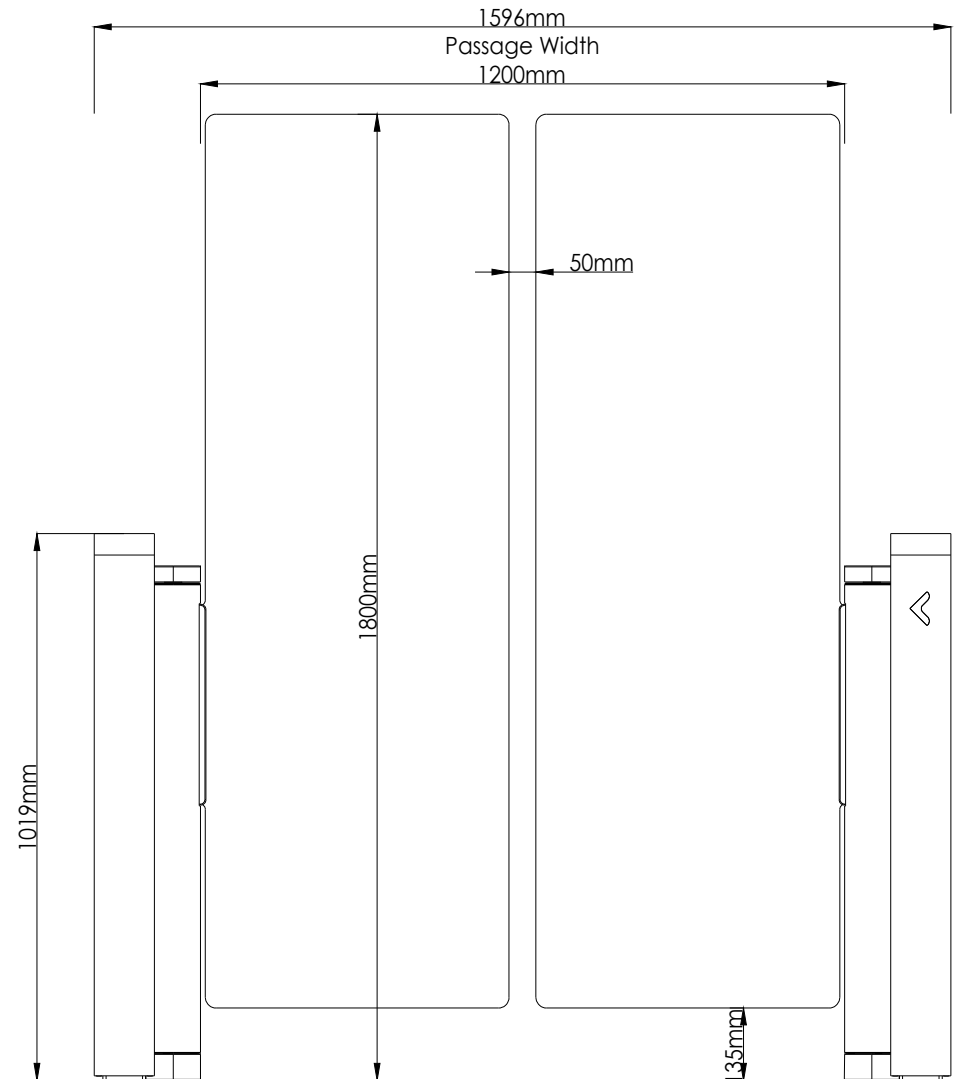

D

C

B

A

4

3

2

1

ASSA ABLOY

DRAWING NAME:
SG 400 BOXED 1750/ 1200-1800

DRAWING NUMBER:
CD-1154-02

DRAWN F.C	DATE 4.06.2026	SIZE A4	REV Rev.002
--------------	-------------------	------------	----------------

SHEET: 1 OF 1

D

C

B

A

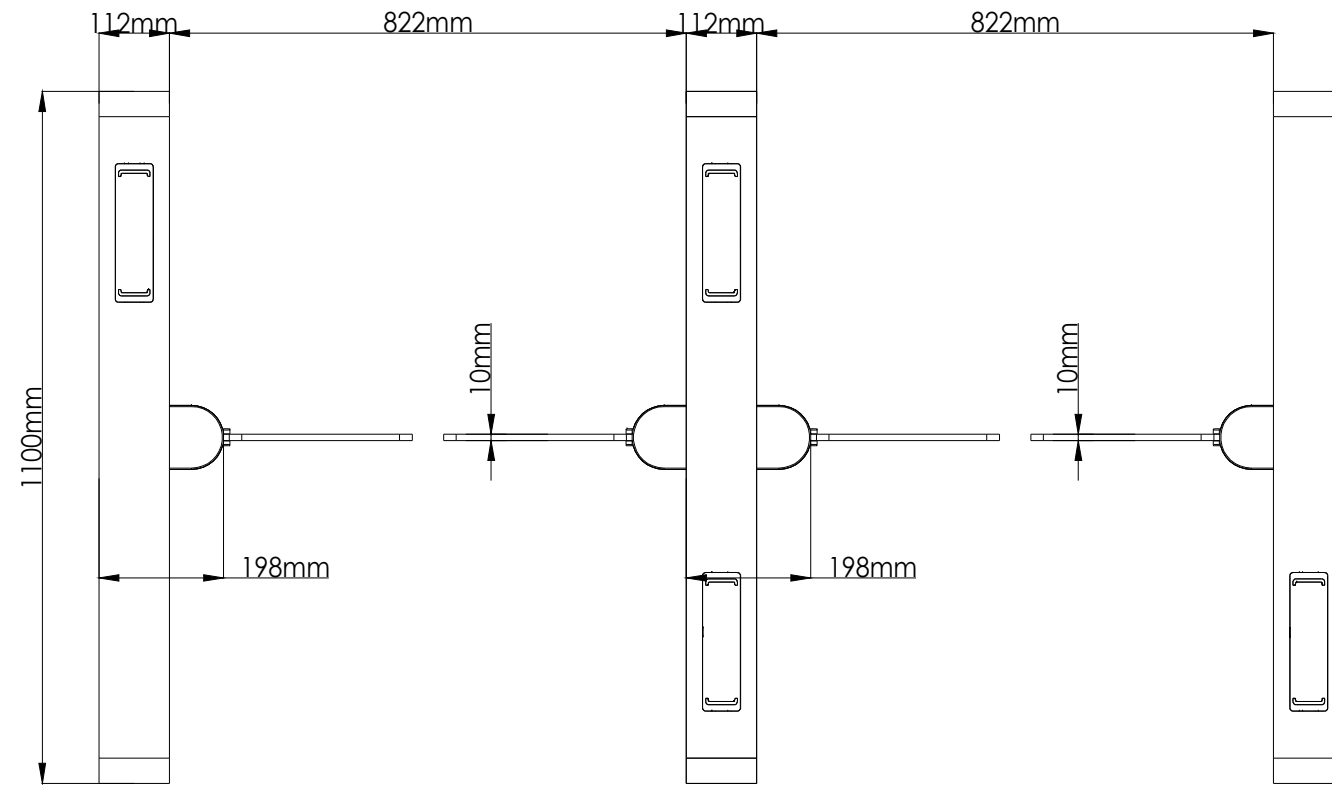
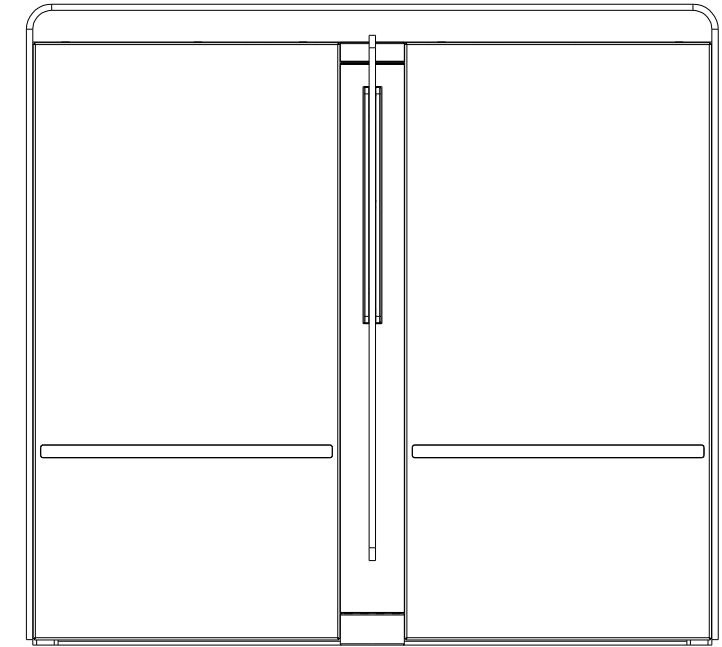
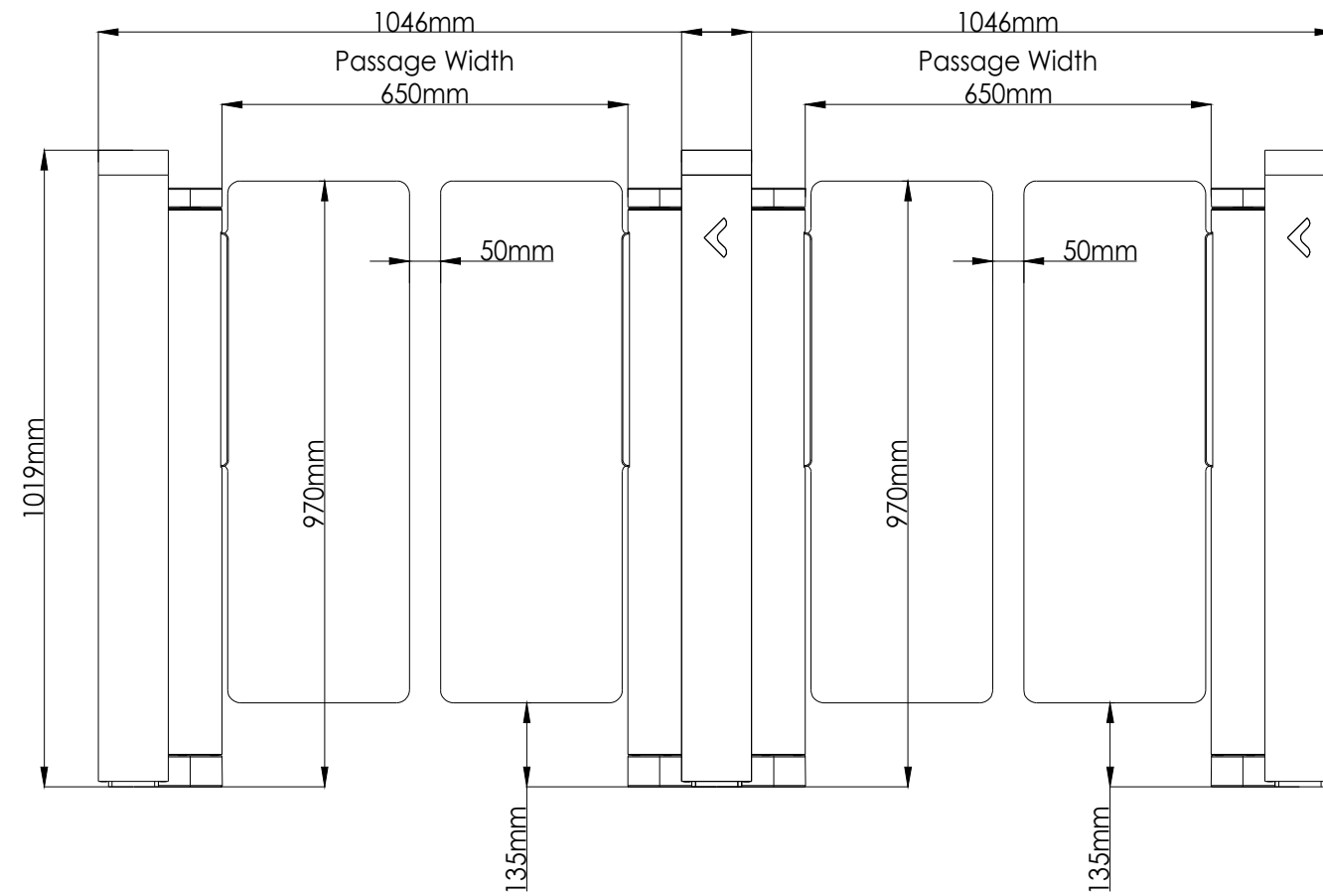

ASSA ABLOY			
DRAWING NAME: SG 400 BOXED 1100/ 650-650-970			
DRAWING NUMBER: CD-1155-02			
DRAWN F.C	DATE 4.06.2026	SIZE A4	REV Rev.002
SHEET: 1 OF 1			

4

3

2

1

D

C

B

A

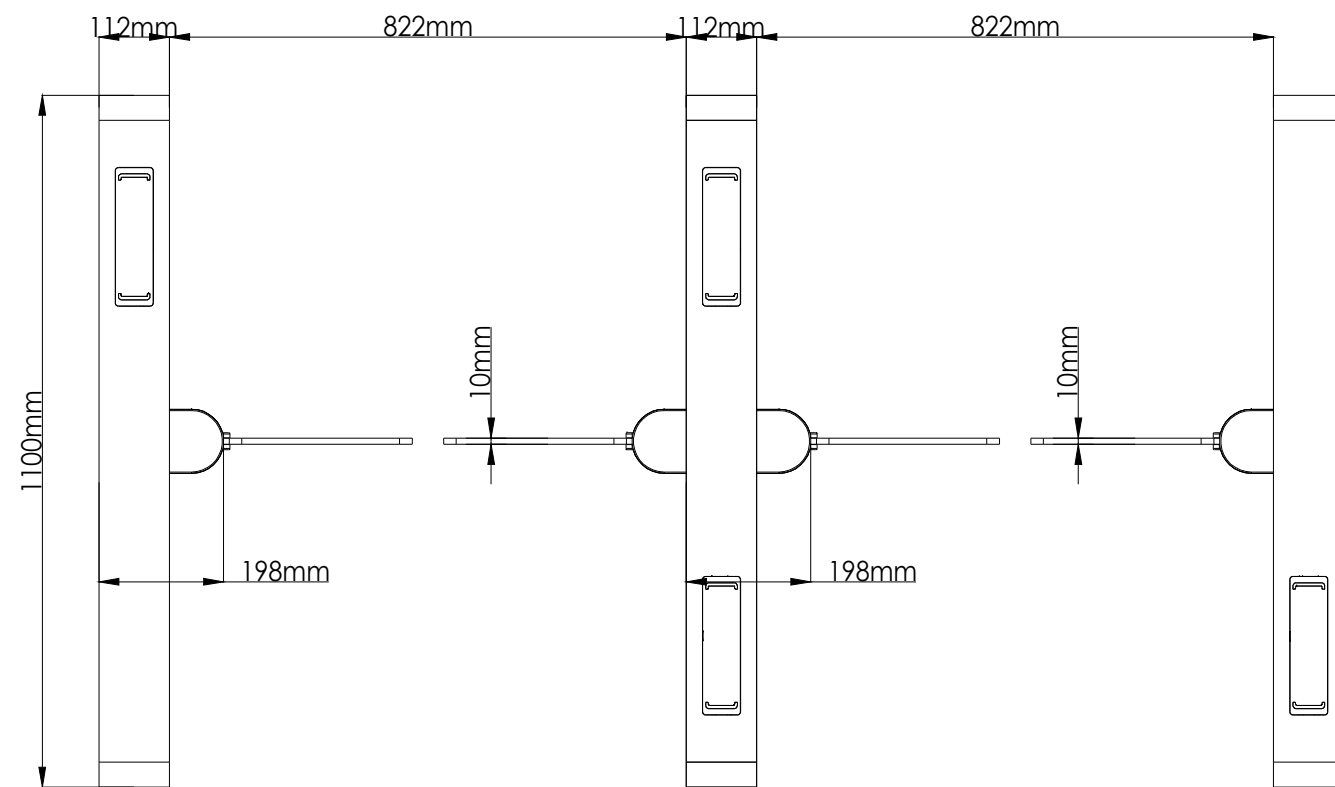
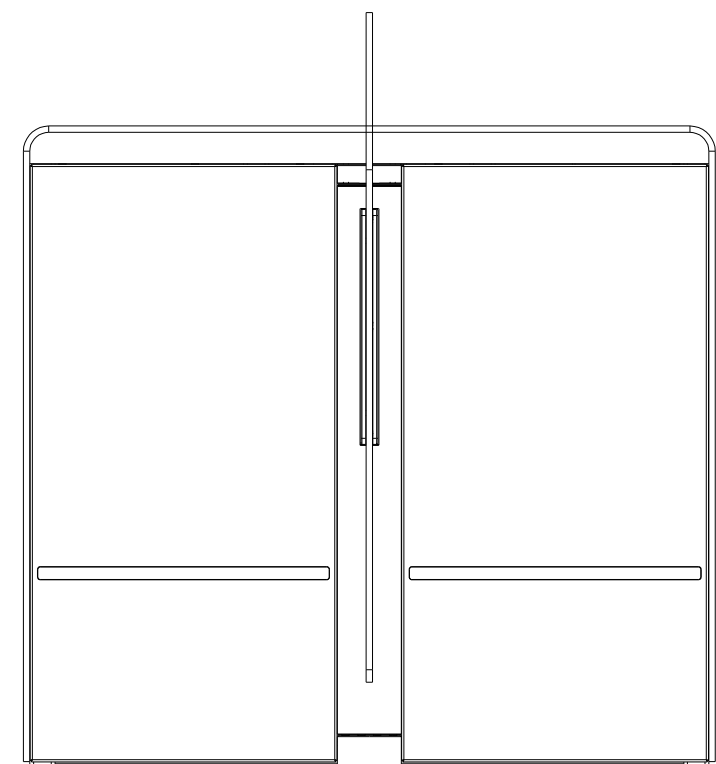
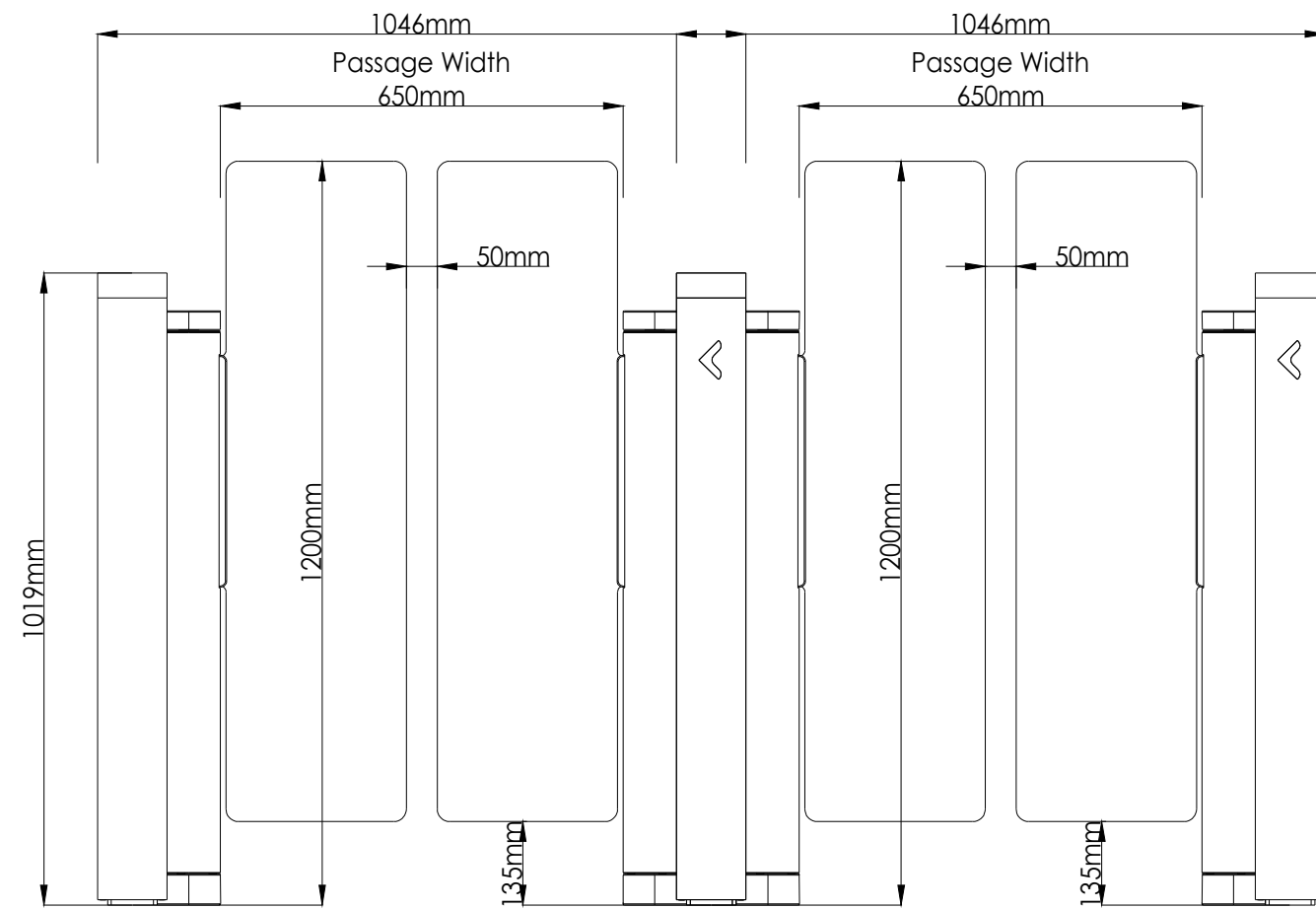

ASSA ABLOY

DRAWING NAME:
SG 400 BOXED 1100/ 650-650-1200

DRAWING NUMBER:
CD-1156-02

DRAWN	DATE	SIZE	REV
F.C	4.06.2026	A4	Rev.002

SHEET: 1 OF 1

4

3

2

1

D

C

B

A

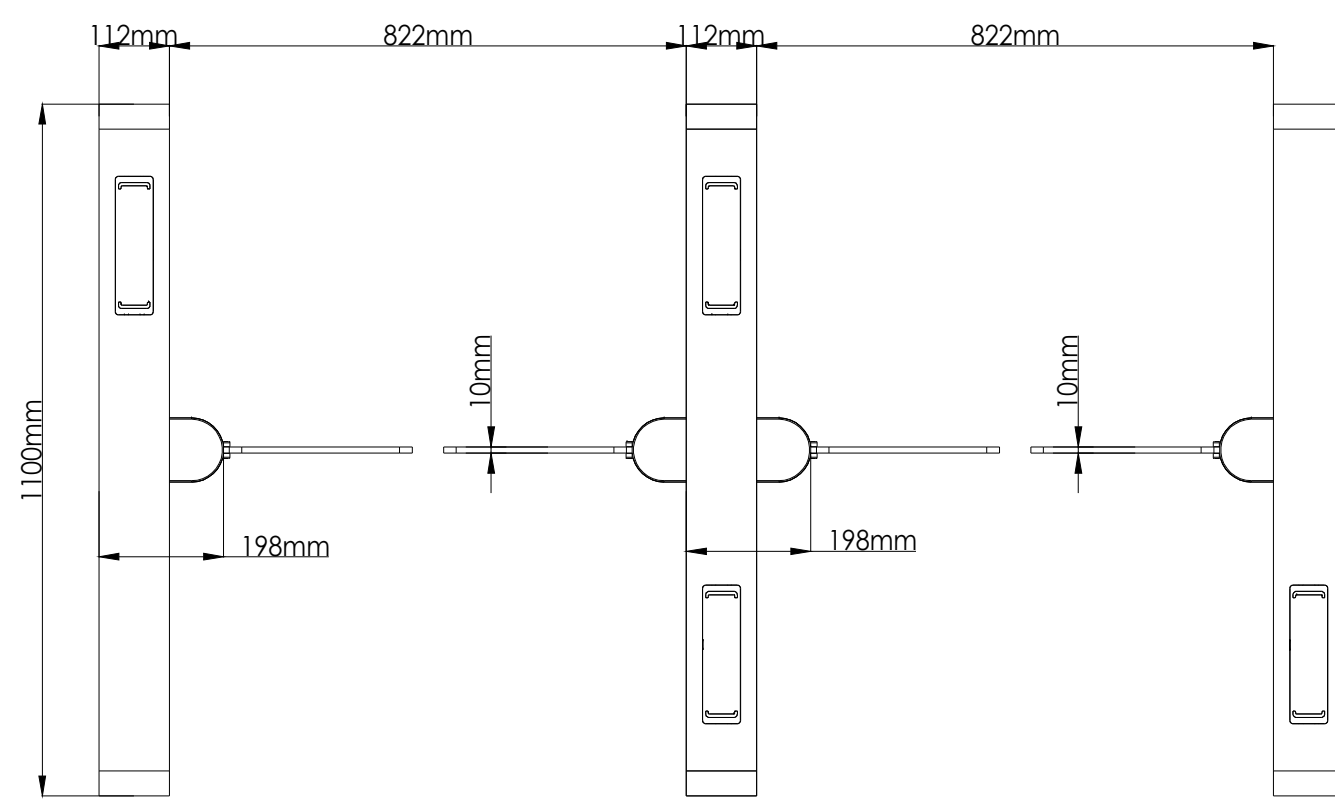
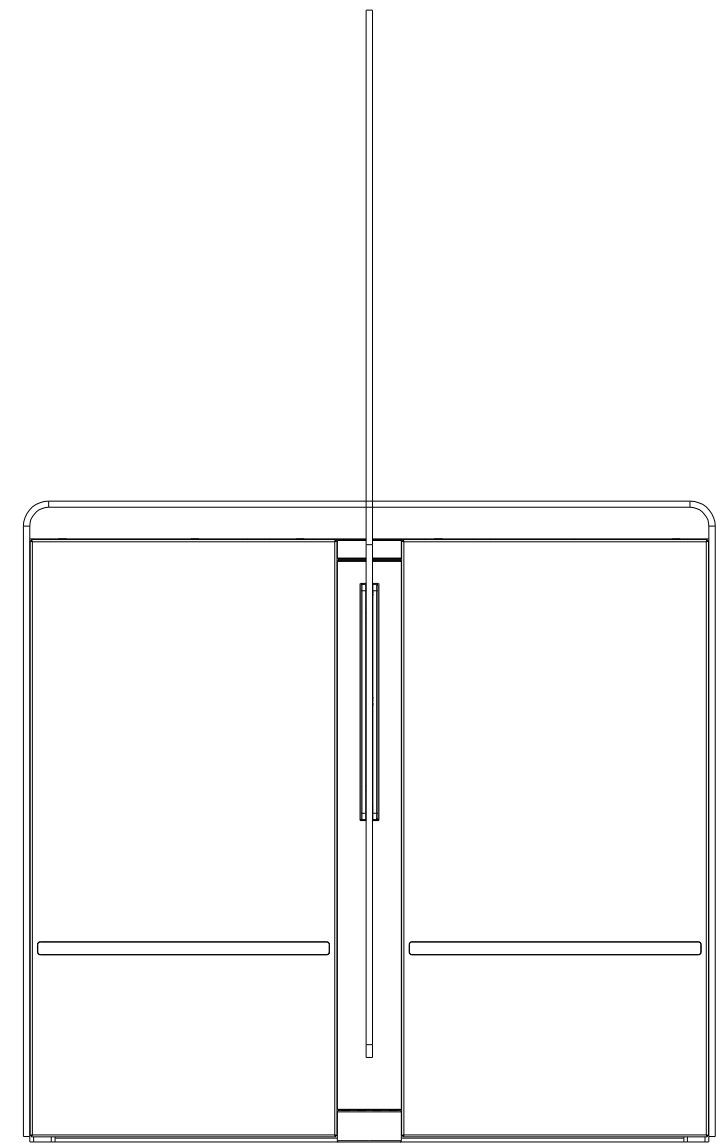
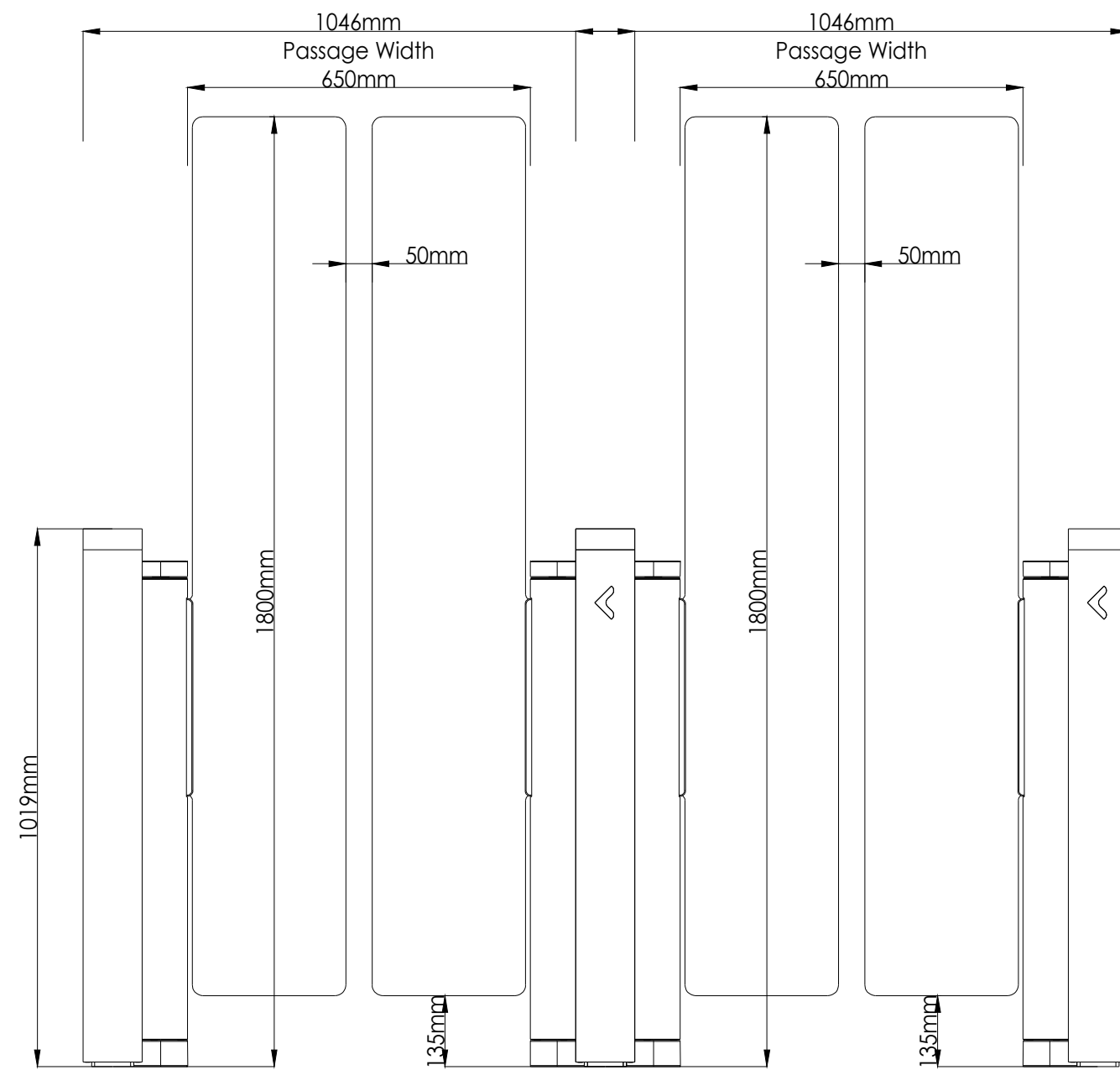

ASSA ABLOY

DRAWING NAME:
SG 400 BOXED 1100/ 650-650-1800

DRAWING NUMBER:
CD-1157-02

DRAWN F.C	DATE 4.06.2026	SIZE A4	REV Rev.002
--------------	-------------------	------------	----------------

SHEET: 1 OF 1

D

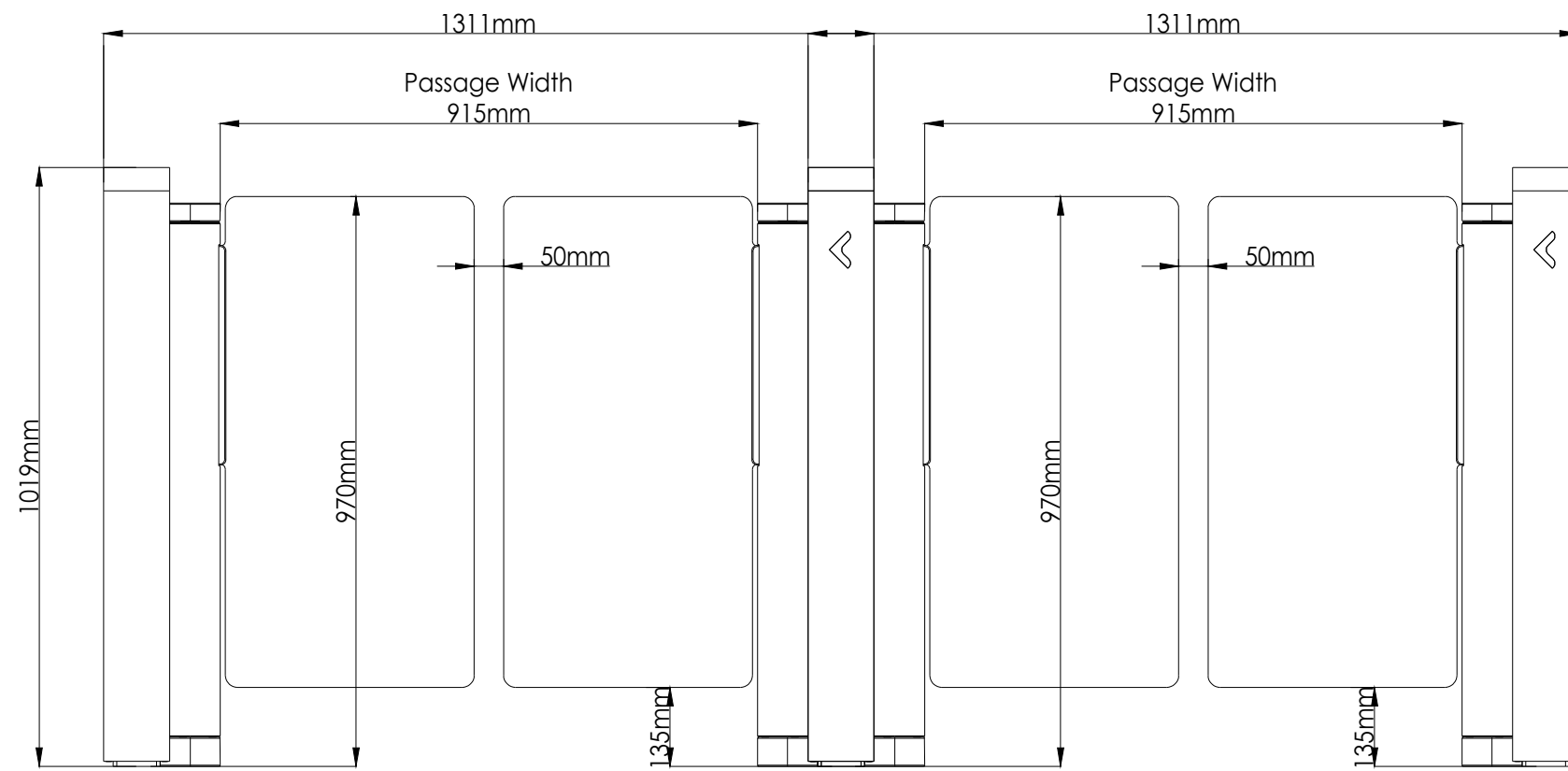

C

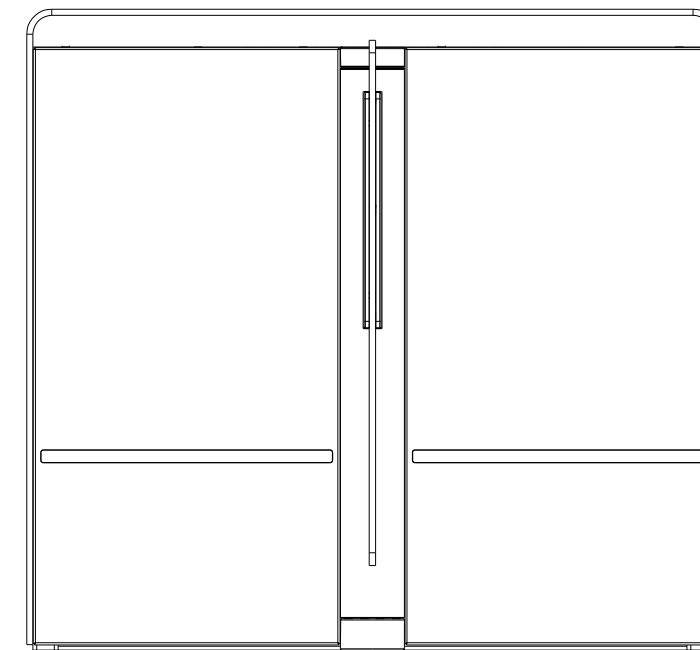

B

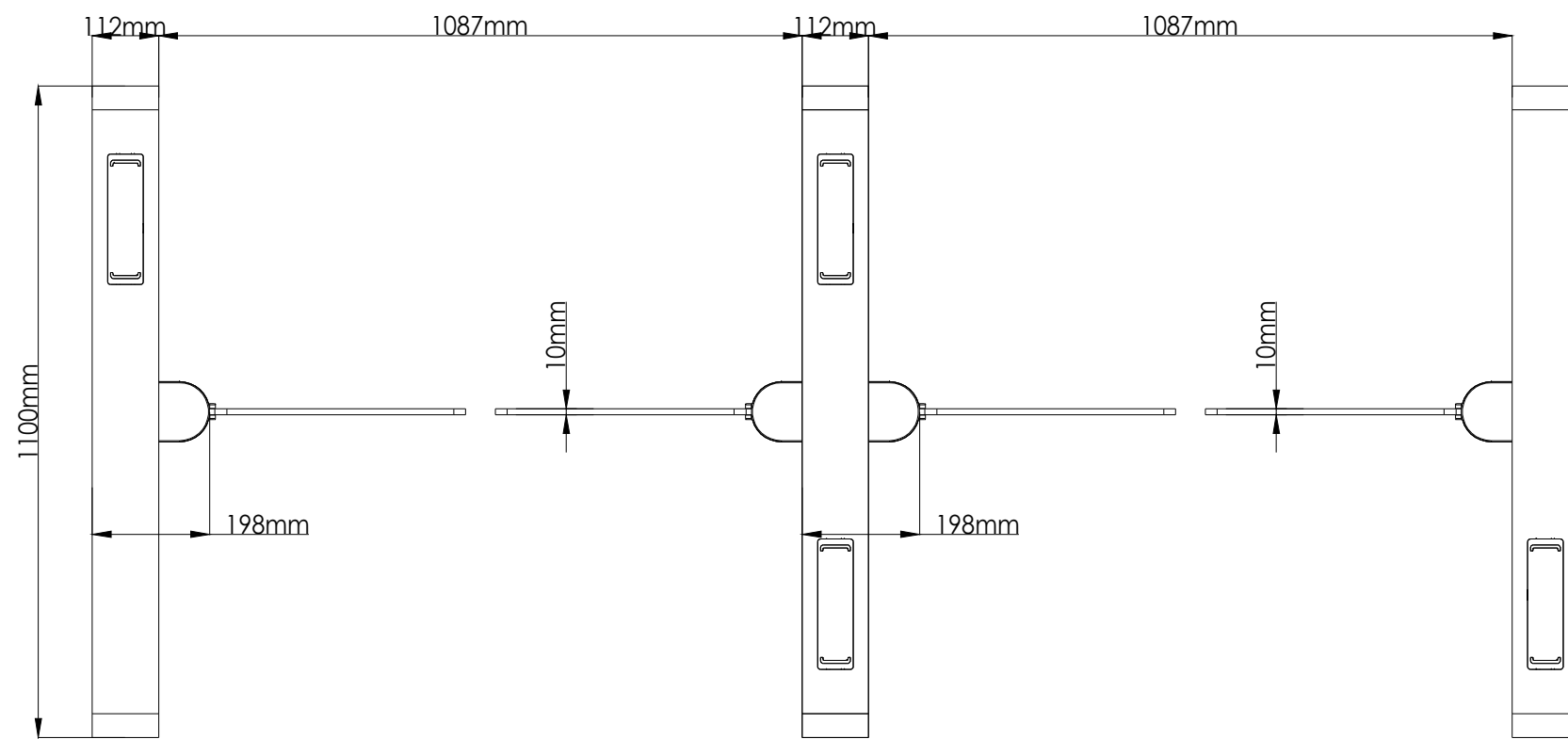

A

ASSA ABLOY

DRAWING NAME:
SG 400 BOXED 1100/ 915-915-970

DRAWING NUMBER:
CD-1158-02

DRAWN F.C	DATE 4.06.2026	SIZE A4	REV Rev.002
--------------	-------------------	------------	----------------

SHEET: 1 OF 1

D

C

B

A

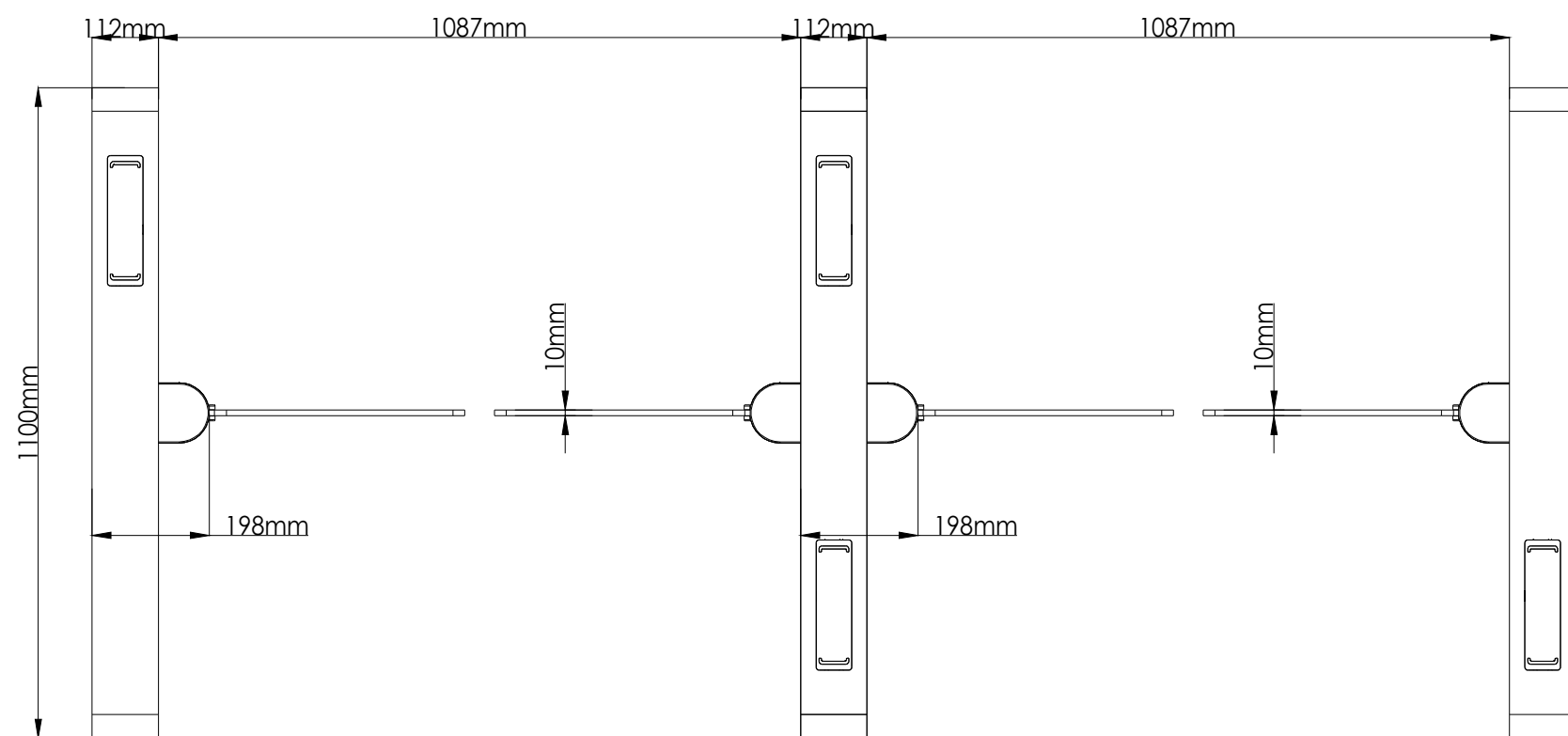
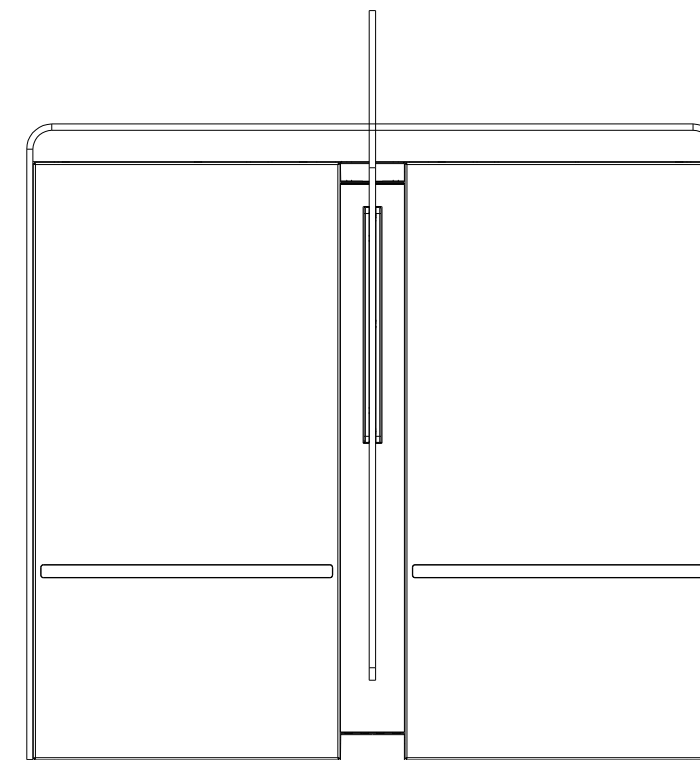
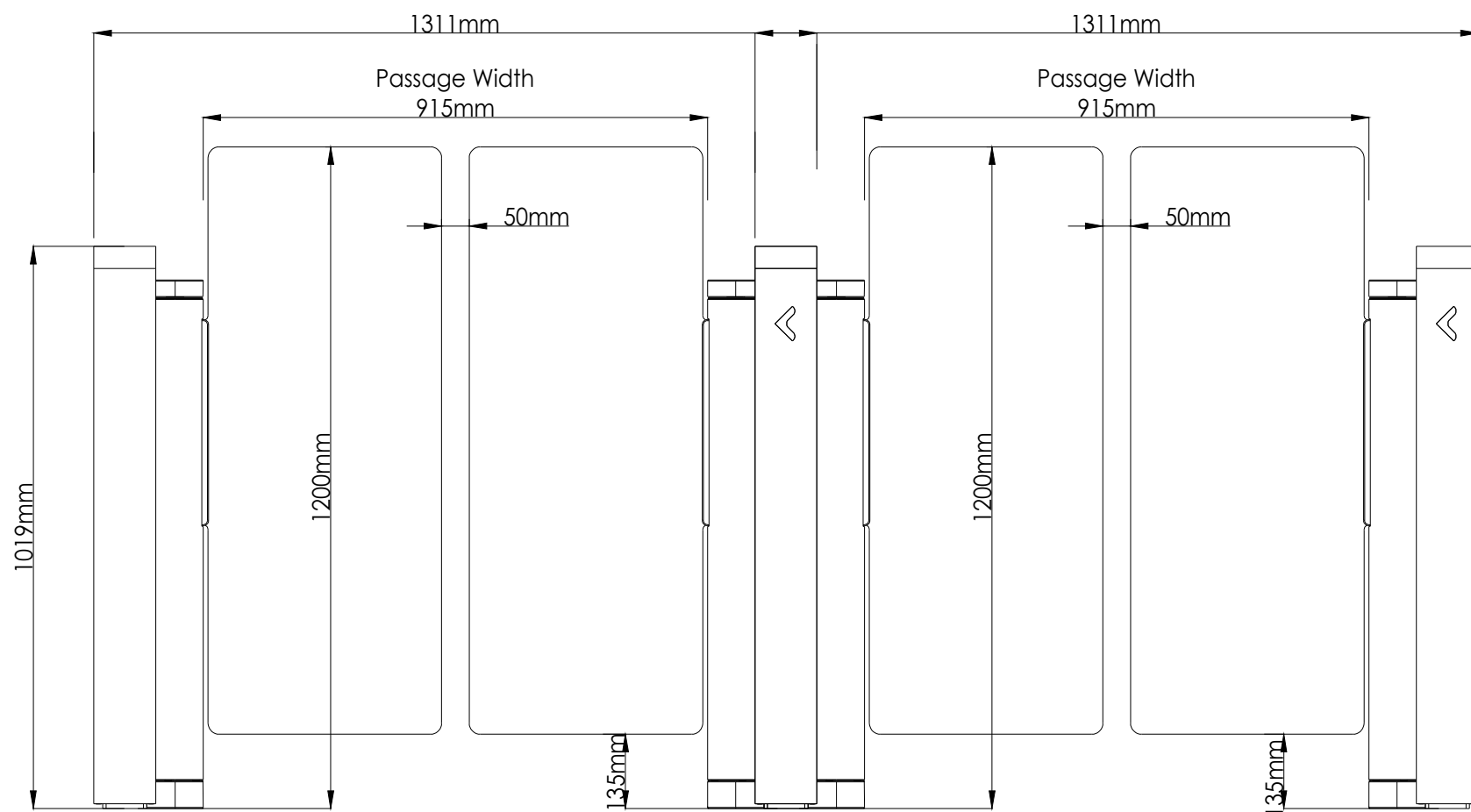

ASSA ABLOY			
DRAWING NAME: SG 400 BOXED 1100/ 915-915-1200			
DRAWING NUMBER: CD-1159-02			
DRAWN F.C	DATE 4.06.2026	SIZE A4	REV Rev.002
SHEET: 1 OF 1			

D

C

B

A

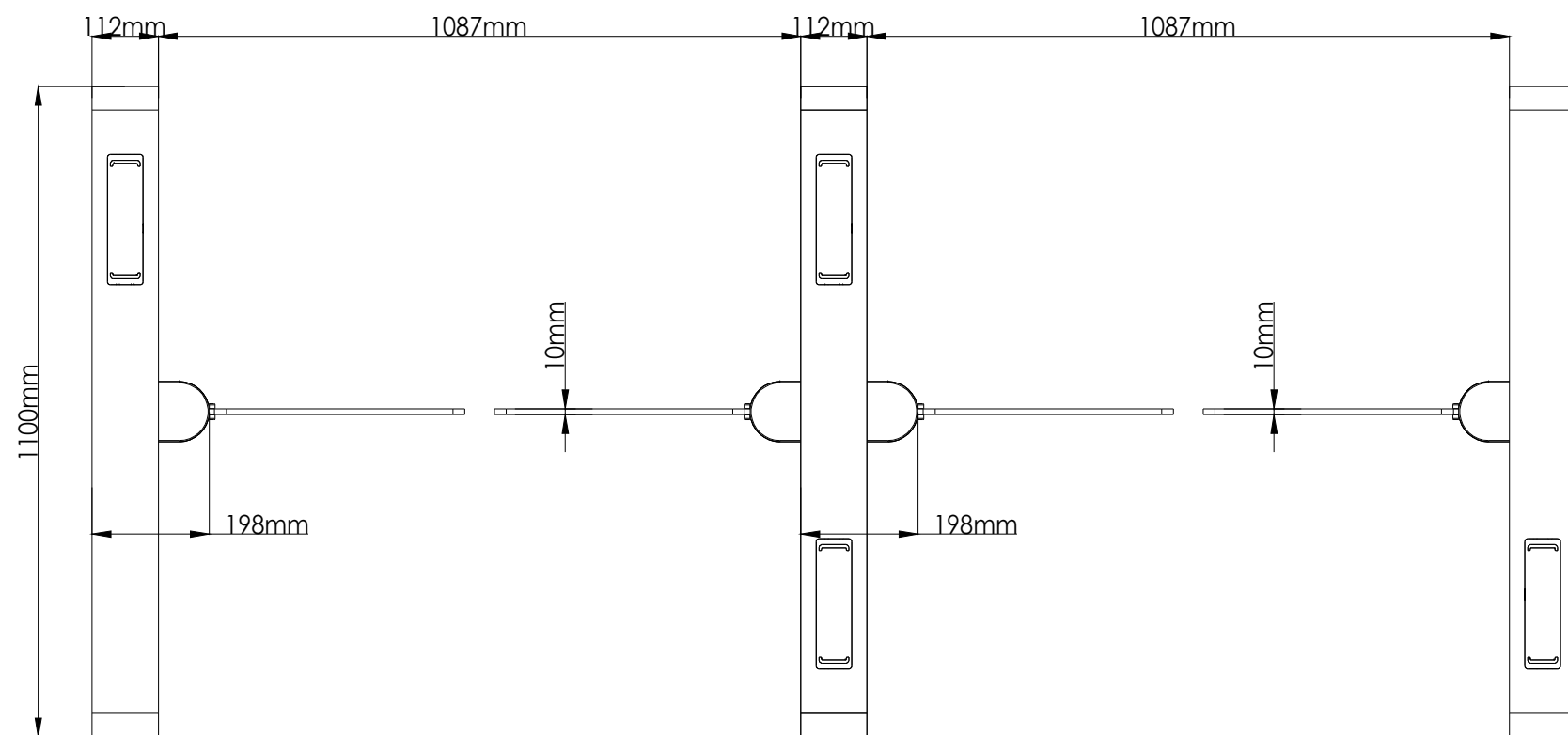
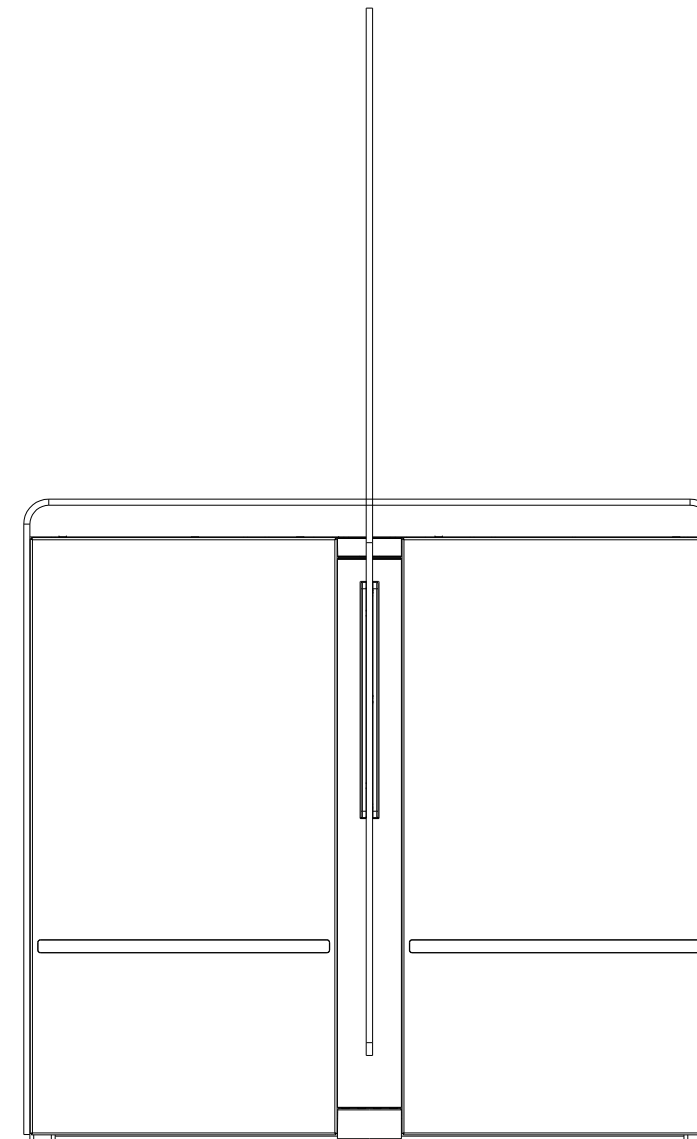
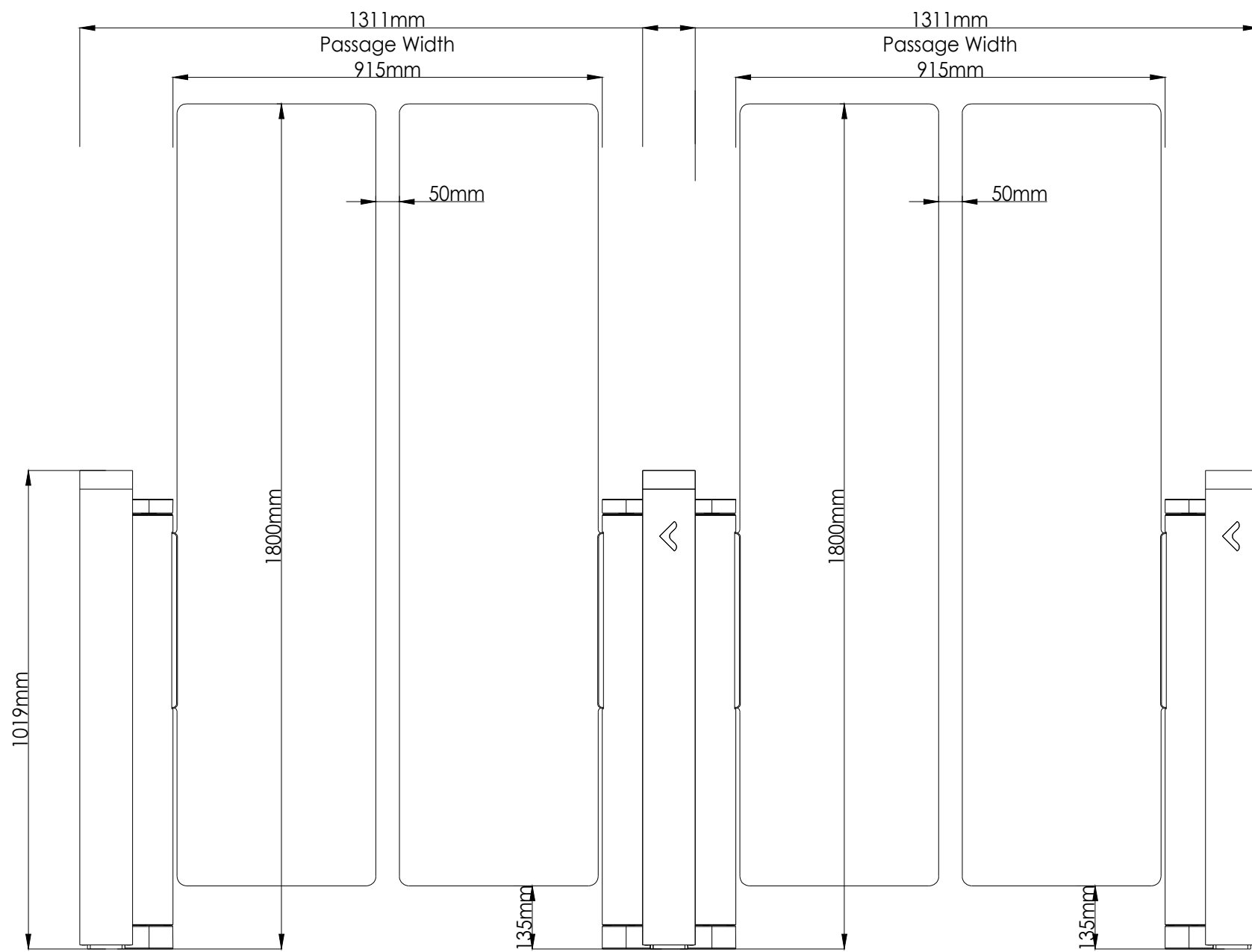

ASSA ABLOY

DRAWING NAME:
SG 400 BOXED 1100/ 915-915-1800

DRAWING NUMBER:
CD-1160-02

DRAWN	DATE	SIZE	REV
F.C	4.06.2026	A4	Rev.002

D

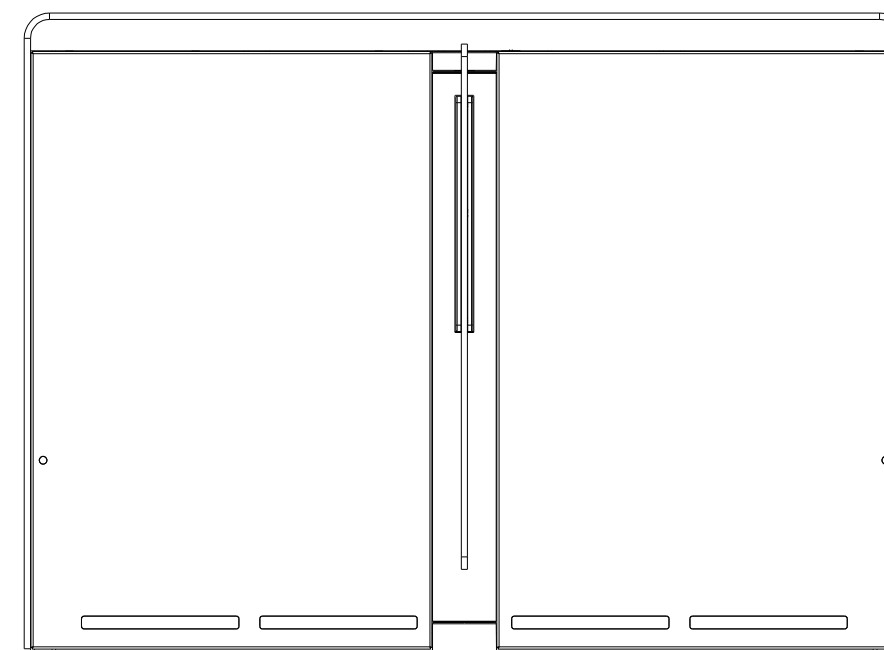
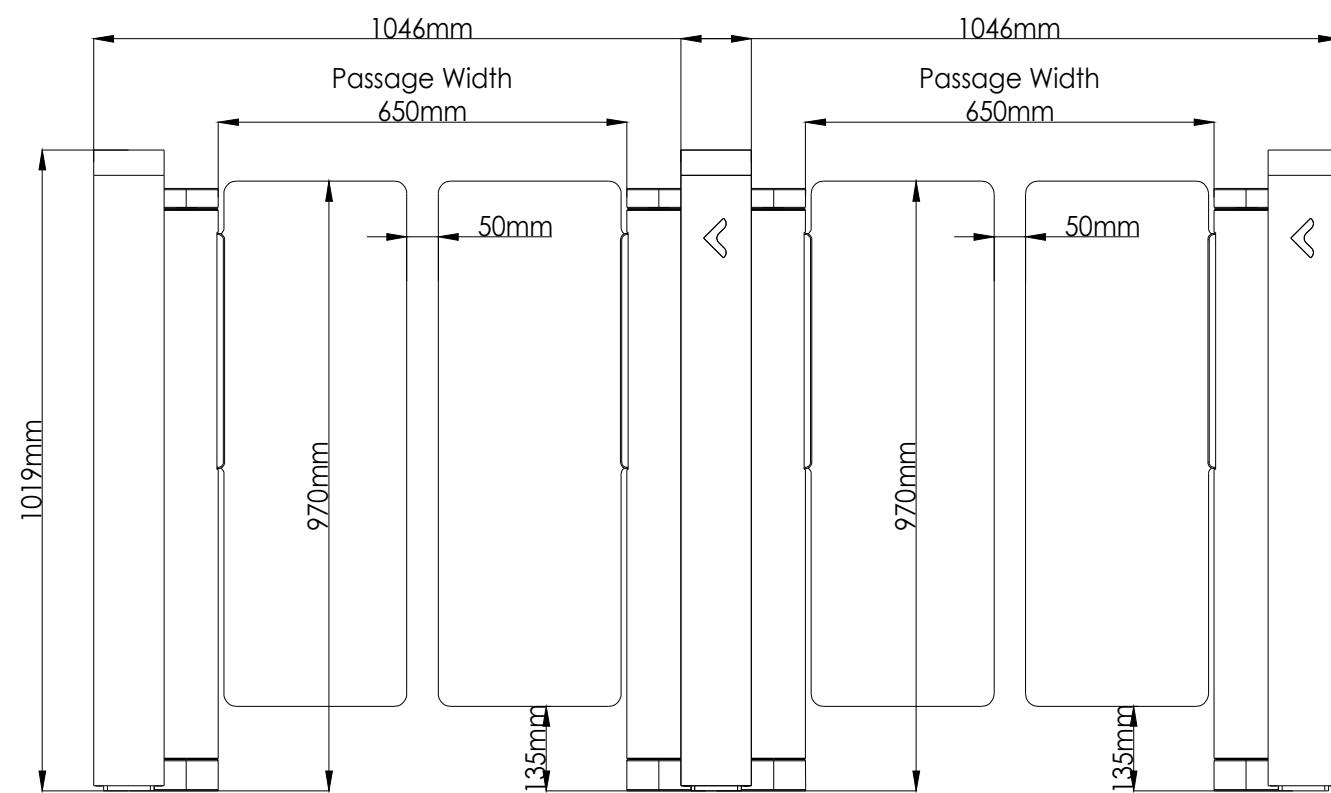

C

B

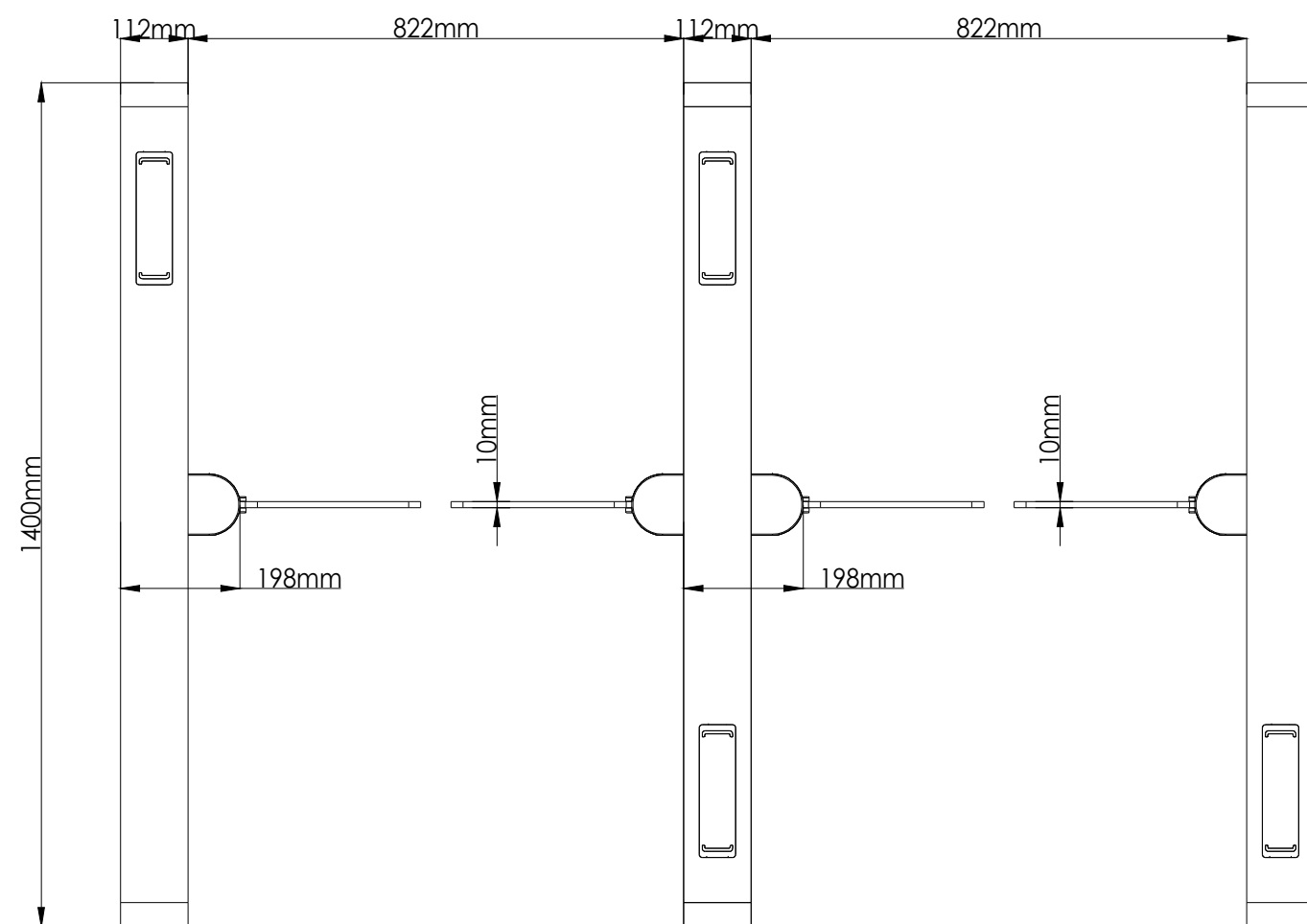

A

ASSA ABLOY			
DRAWING NAME: SG 400 BOXED 1400/ 650-650-970			
DRAWING NUMBER: CD-1161-02			
DRAWN F.C	DATE 4.06.2026	SIZE A4	REV Rev.002
SHEET: 1 OF 1			

4

3

2

1

D

C

B

A

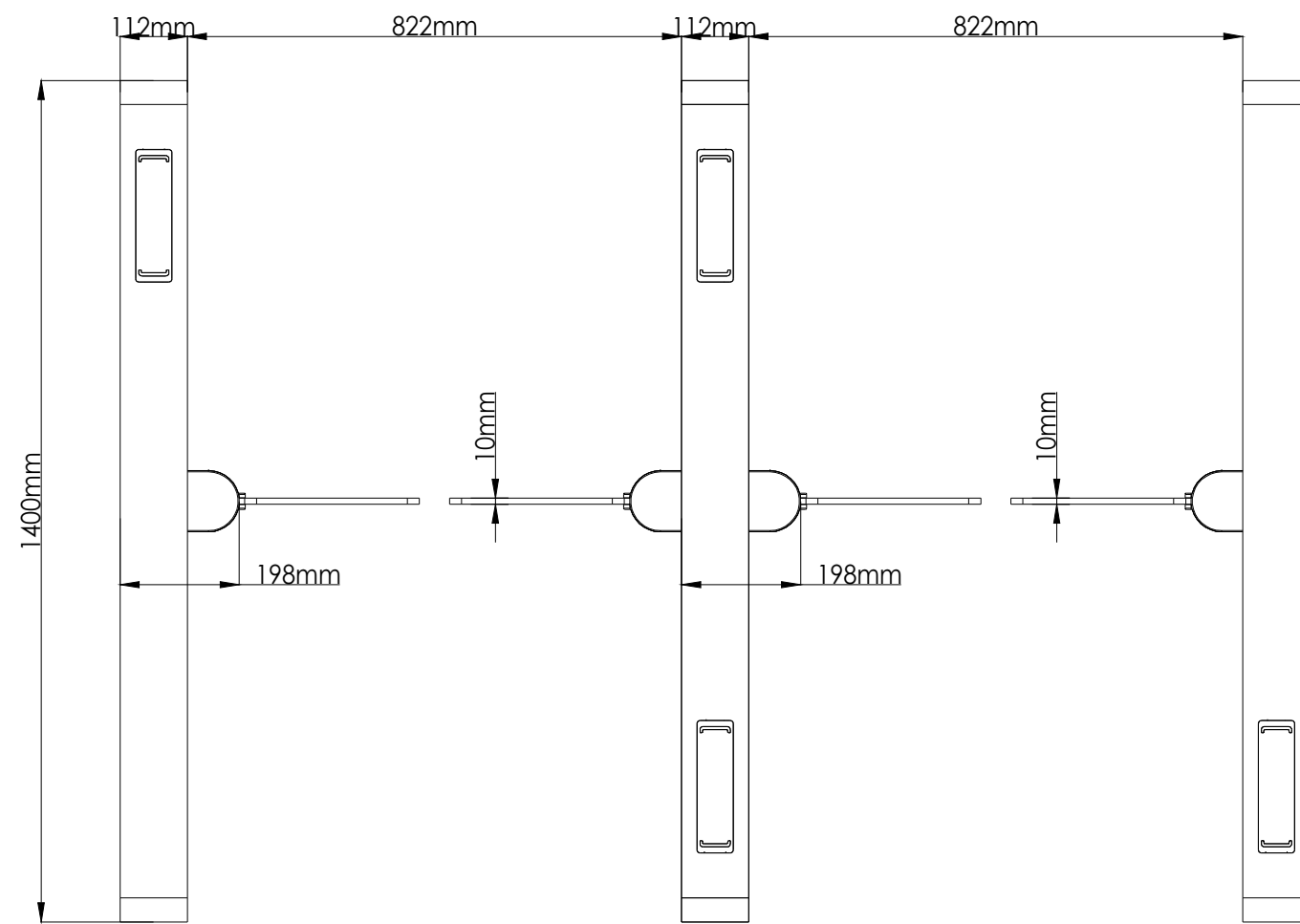
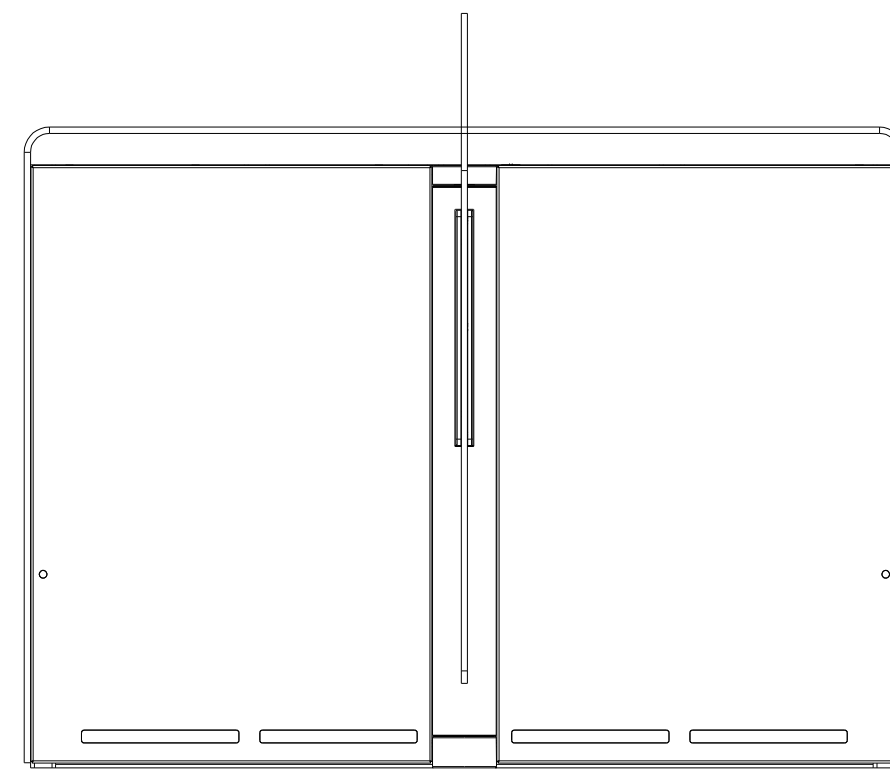
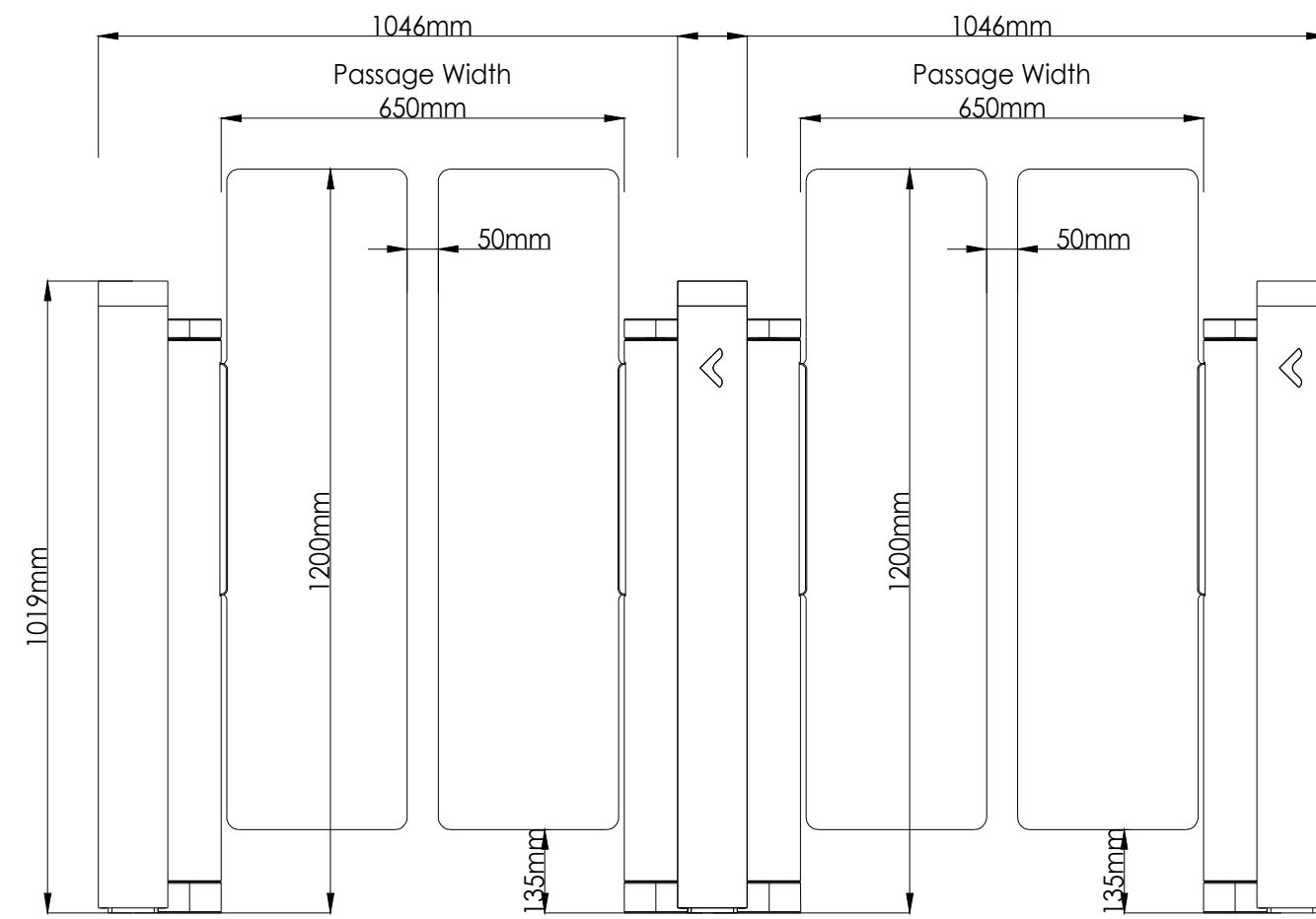

ASSA ABLOY

DRAWING NAME:
SG 400 BOXED 1400/ 650-650-1200

DRAWING NUMBER:
CD-1162-02

DRAWN F.C	DATE 4.06.2026	SIZE A4	REV Rev.002
--------------	-------------------	------------	----------------

SHEET: 1 OF 1

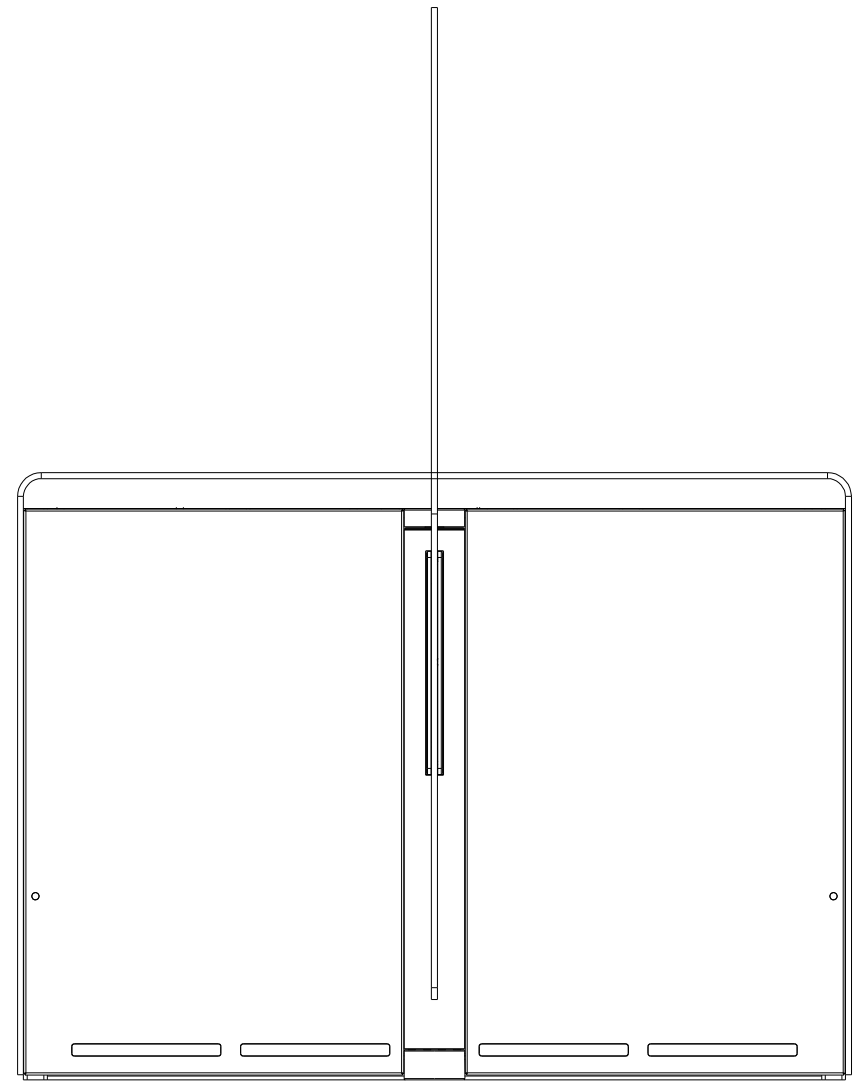
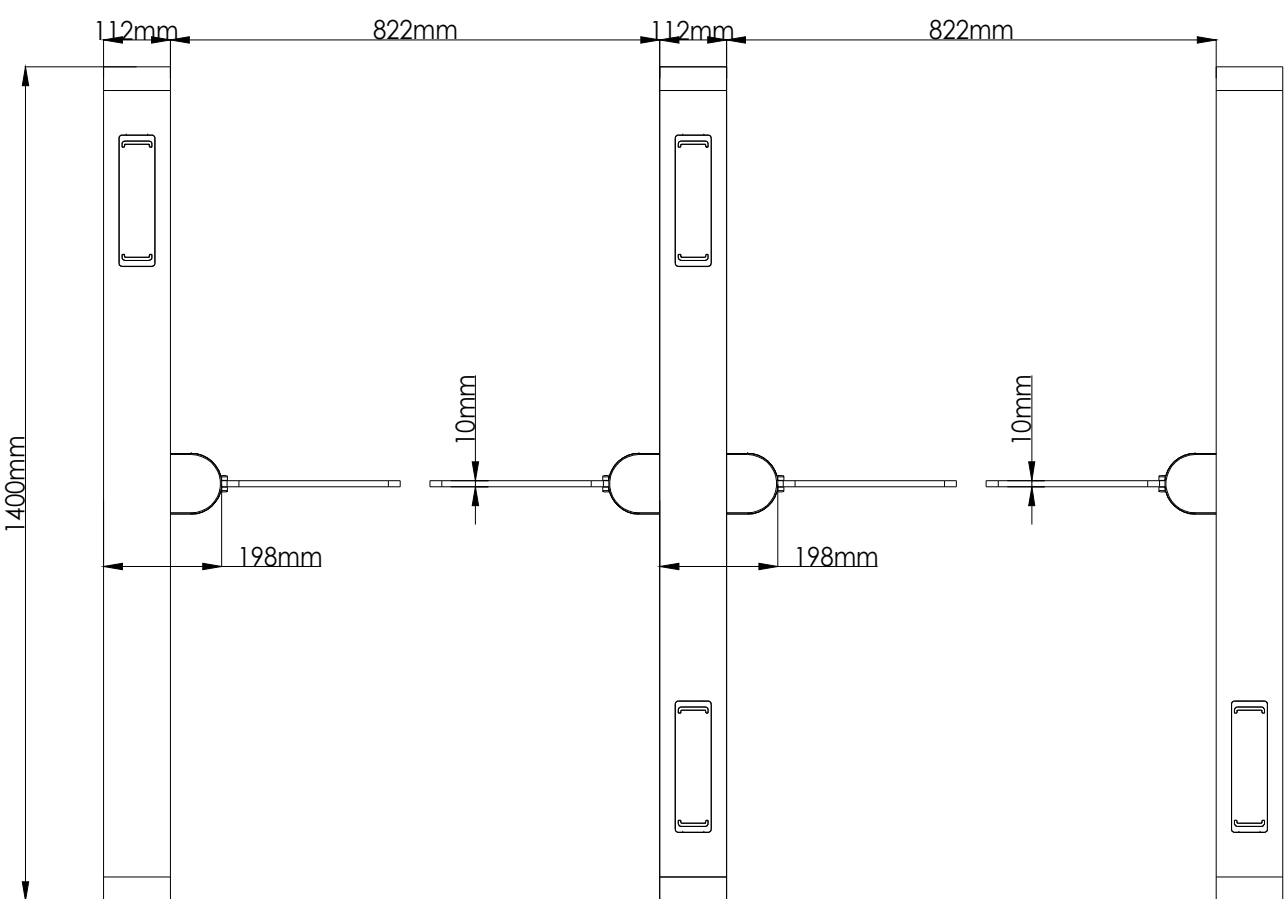
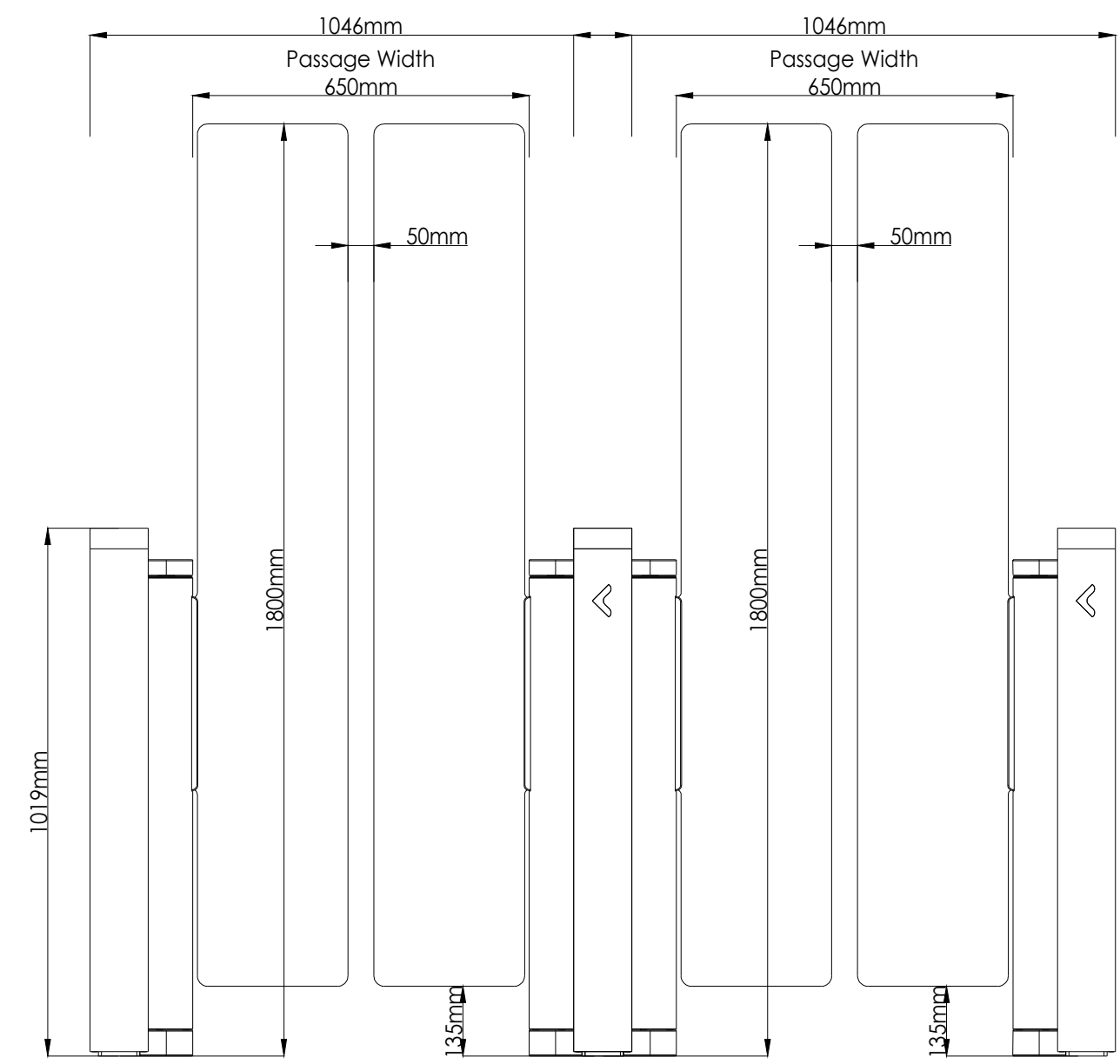

D

C

B

A

ASSA ABLOY			
DRAWING NAME: SG 400 BOXED 1400/ 650-650-1800			
DRAWING NUMBER: CD-1163-02			
DRAWN F.C	DATE 4.06.2026	SIZE A4	REV Rev.002
SHEET: 1 OF 1			

D

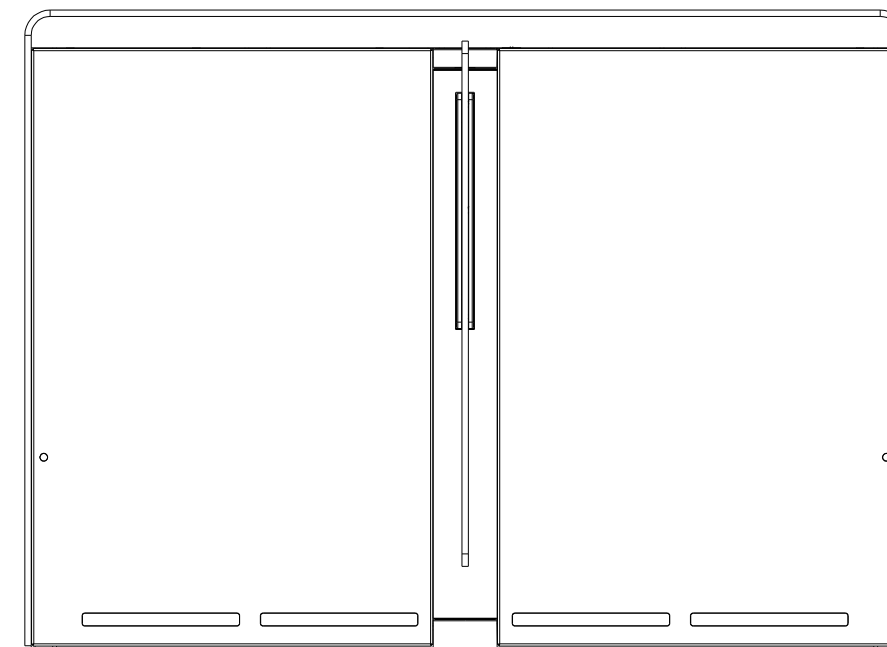
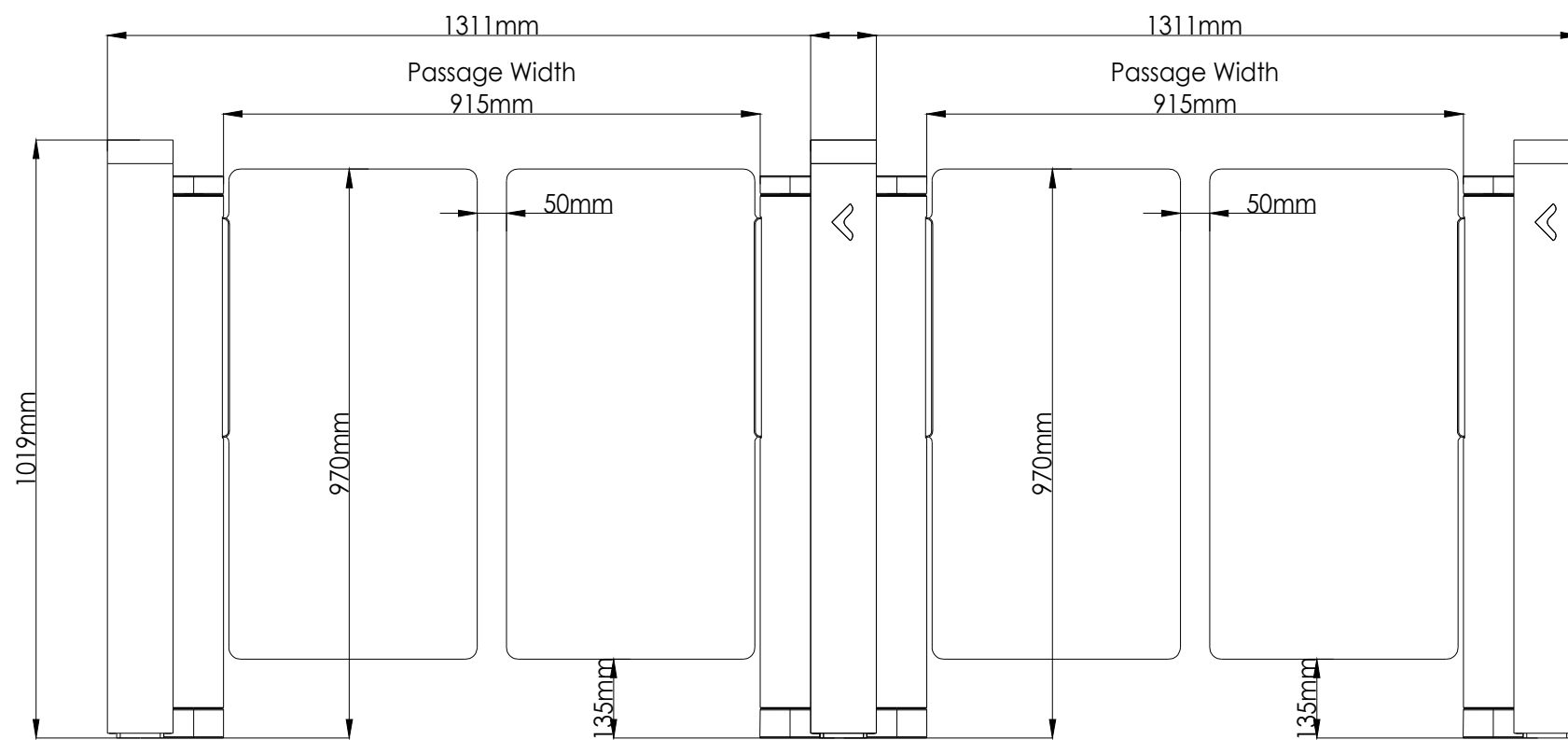

C

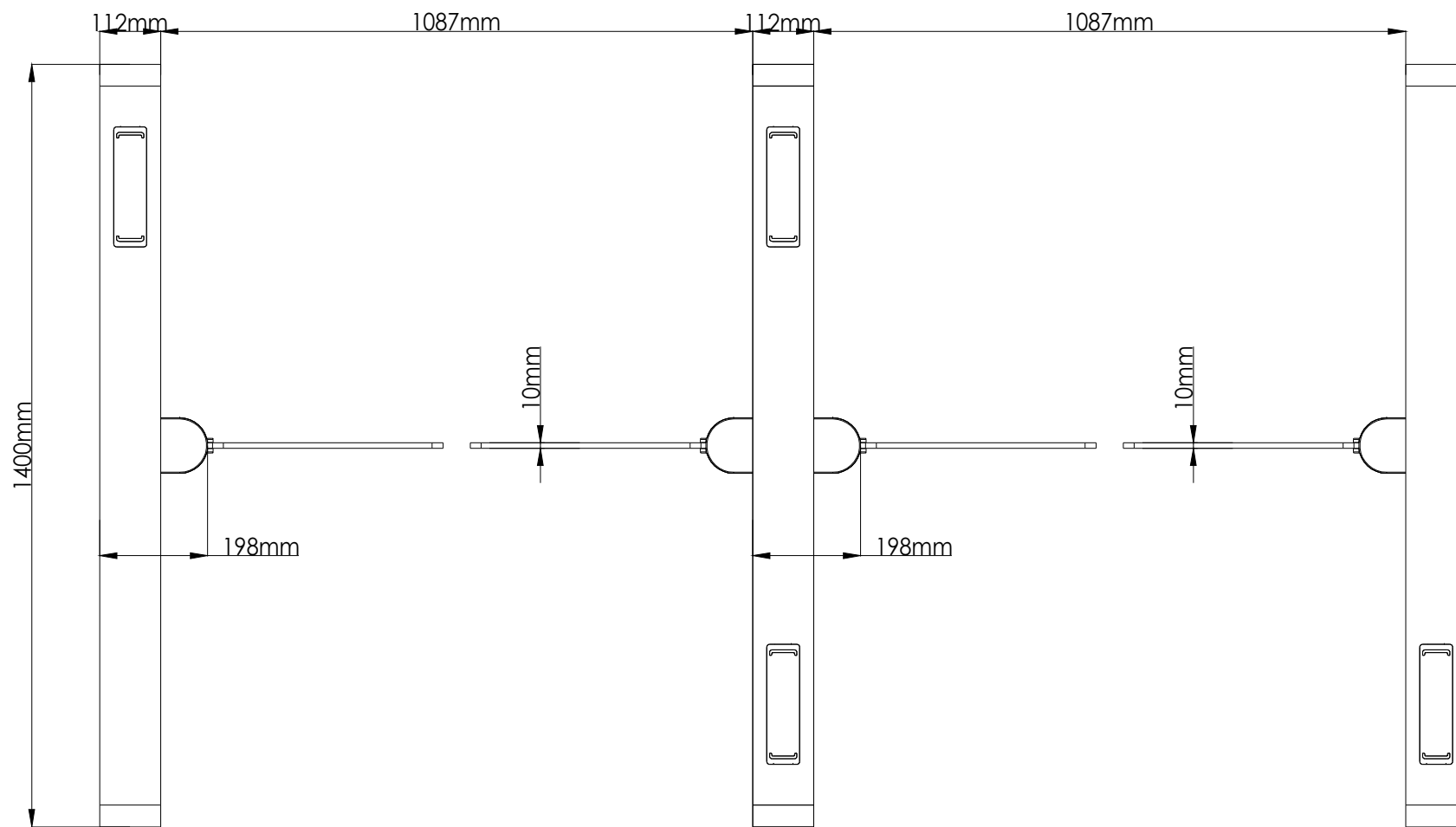

B

A

ASSA ABLOY

DRAWING NAME:
SG 400 BOXED 1400/ 915-915-970

DRAWING NUMBER:
CD-1164-02

DRAWN F.C	DATE 4.06.2026	SIZE A4	REV Rev.002
--------------	-------------------	------------	----------------

4

3

2

1

D

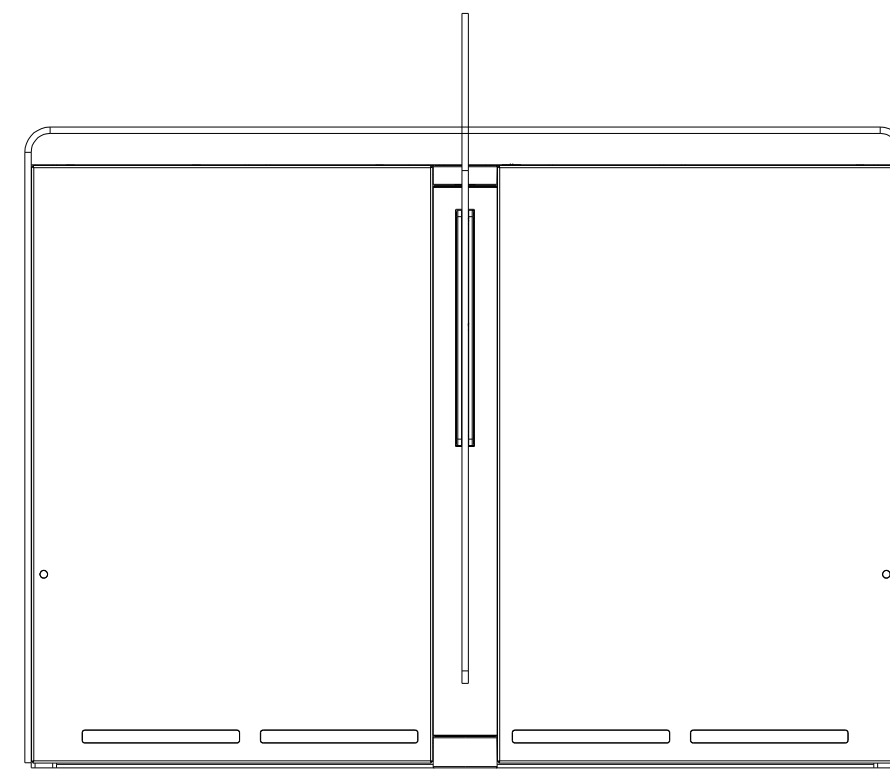
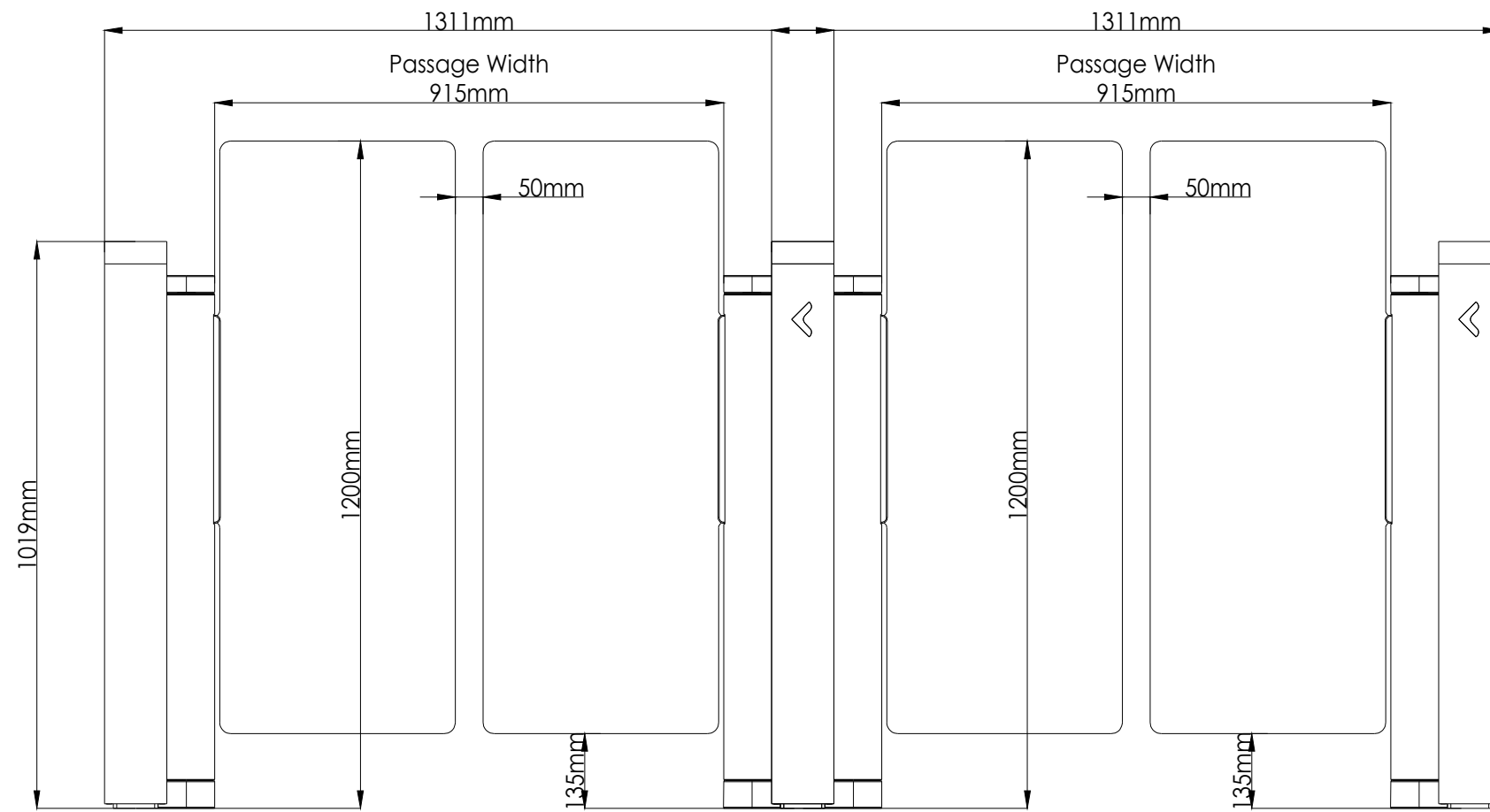

C

B

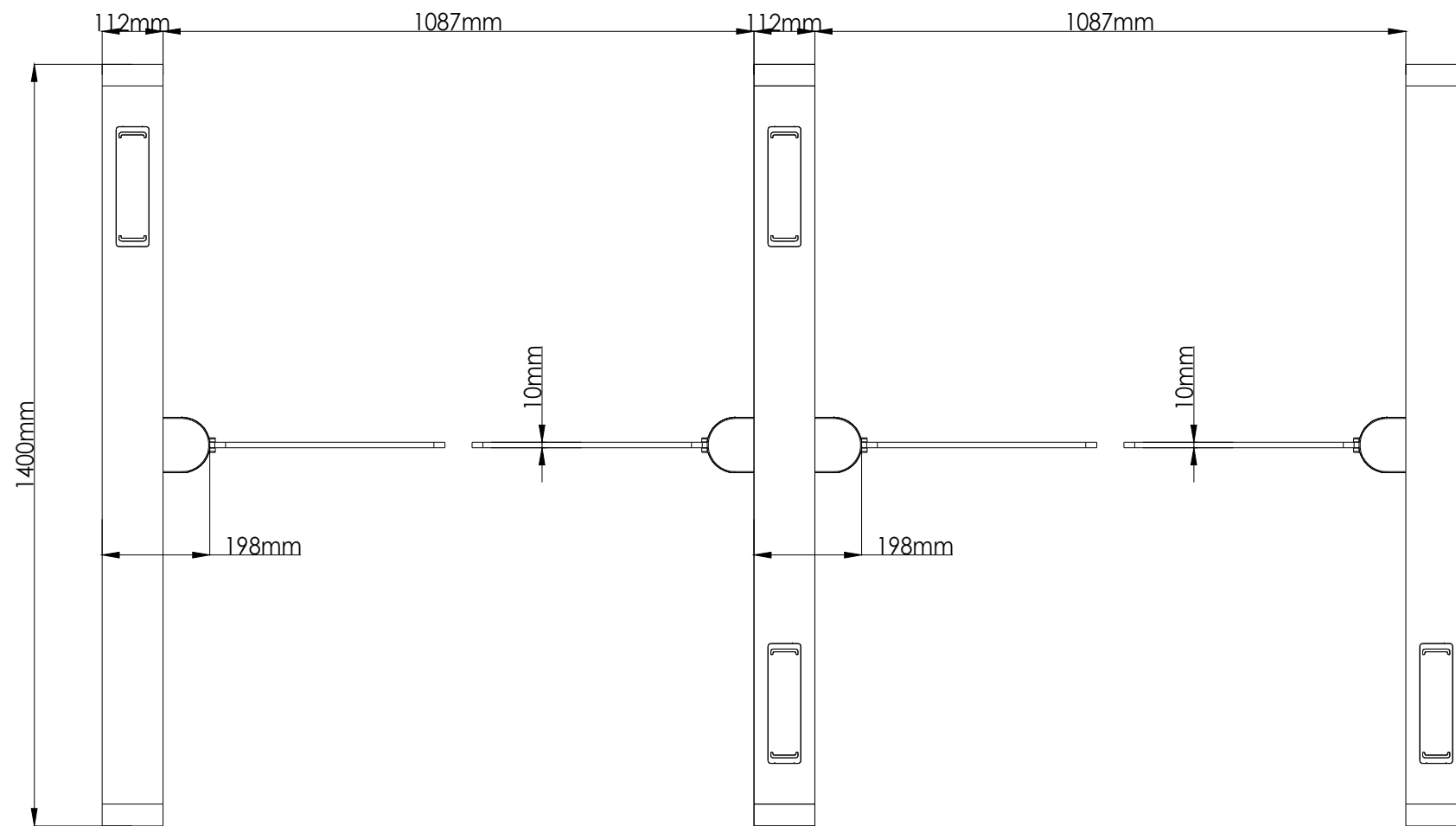

A

ASSA ABLOY

DRAWING NAME:
SG 400 BOXED 1400/ 915-915-1200

DRAWING NUMBER:
CD-1165-02

DRAWN	DATE	SIZE	REV
F.C	4.06.2026	A4	Rev.002

SHEET: 1 OF 1

4

3

2

1

D

C

B

A

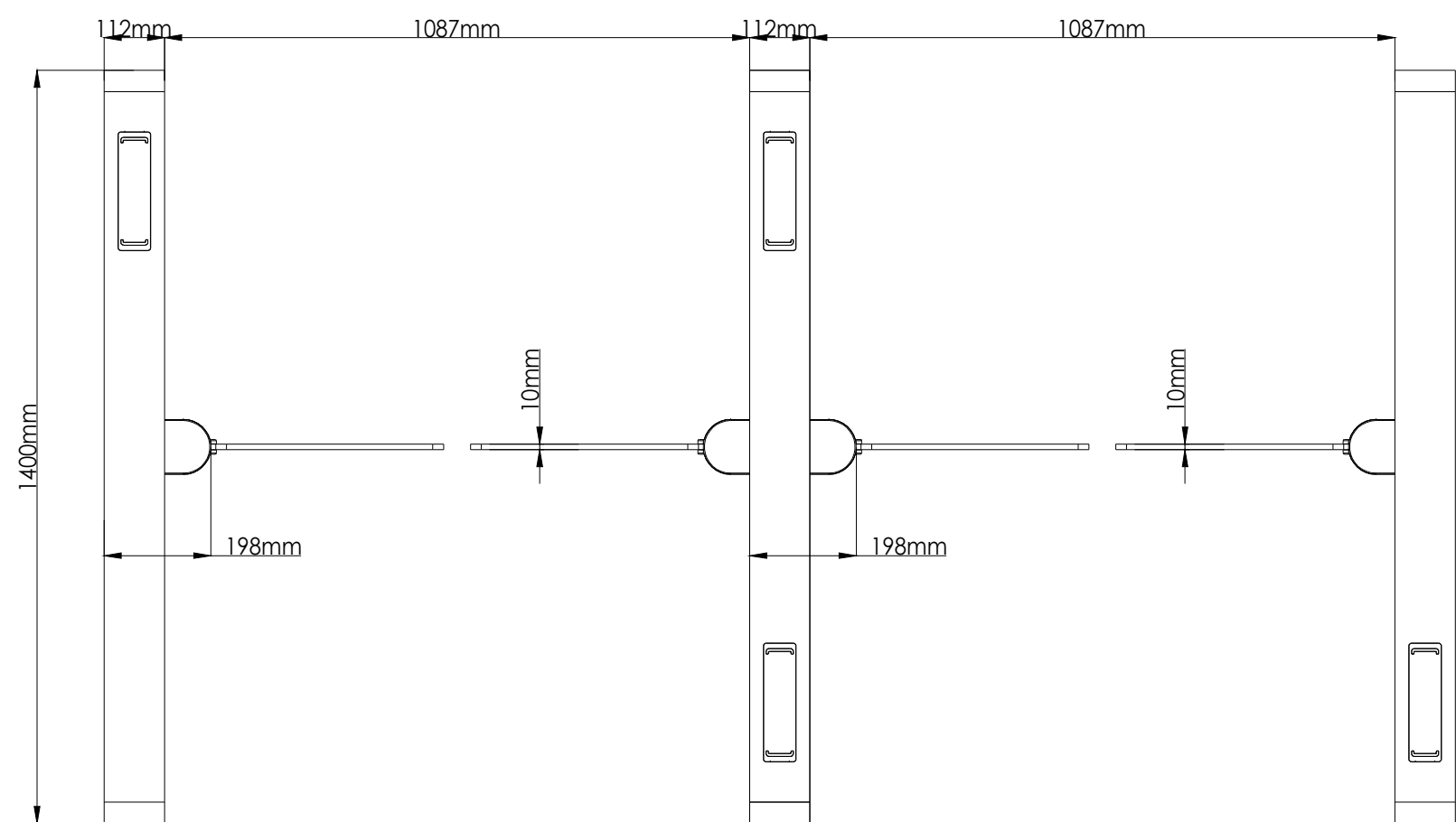
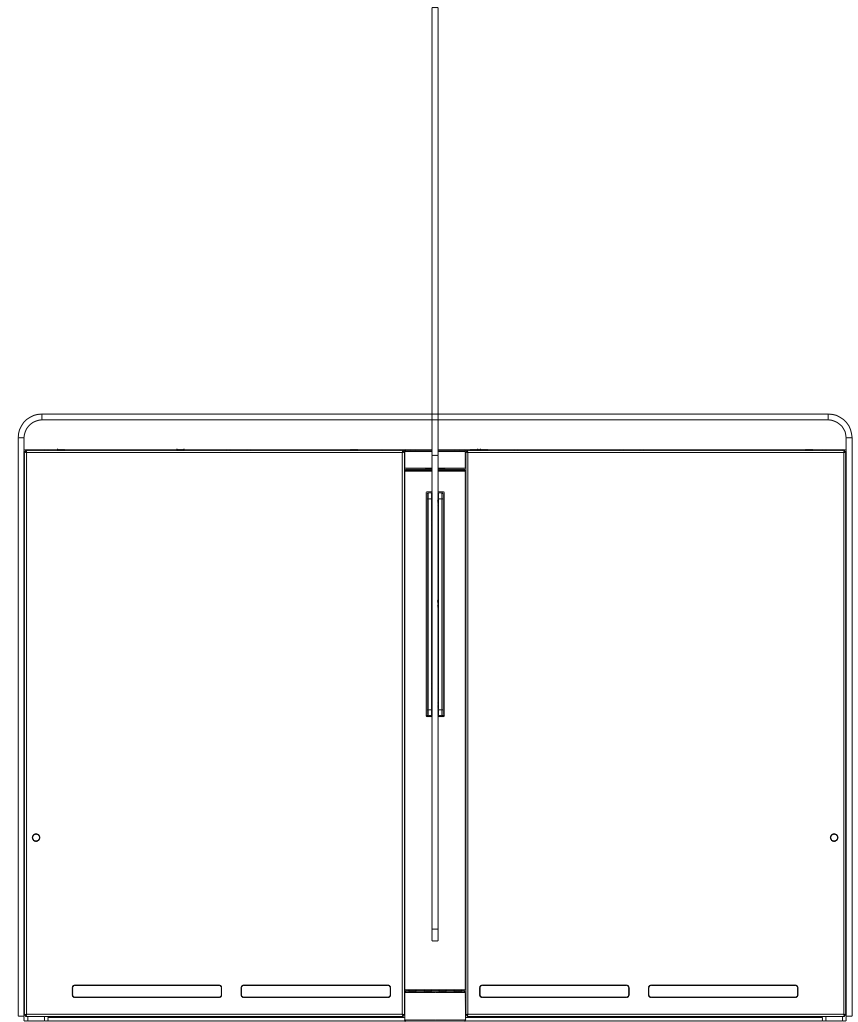
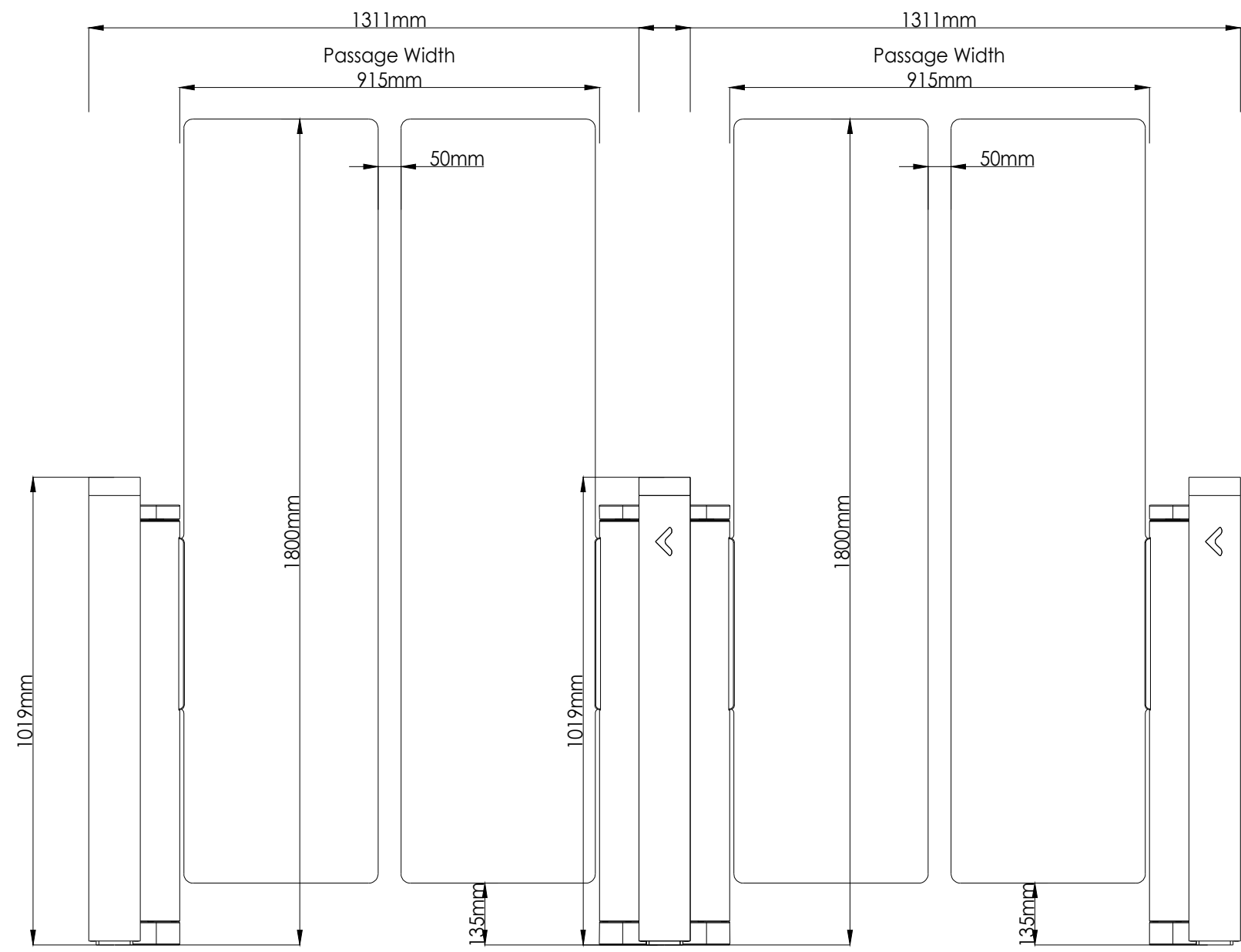

ASSA ABLOY			
DRAWING NAME: SG 400 BOXED 1400/ 915-915-1800			
DRAWING NUMBER: CD-1166-02			
DRAWN F.C	DATE 4.06.2026	SIZE A4	REV Rev.002
SHEET: 1 OF 1			

D

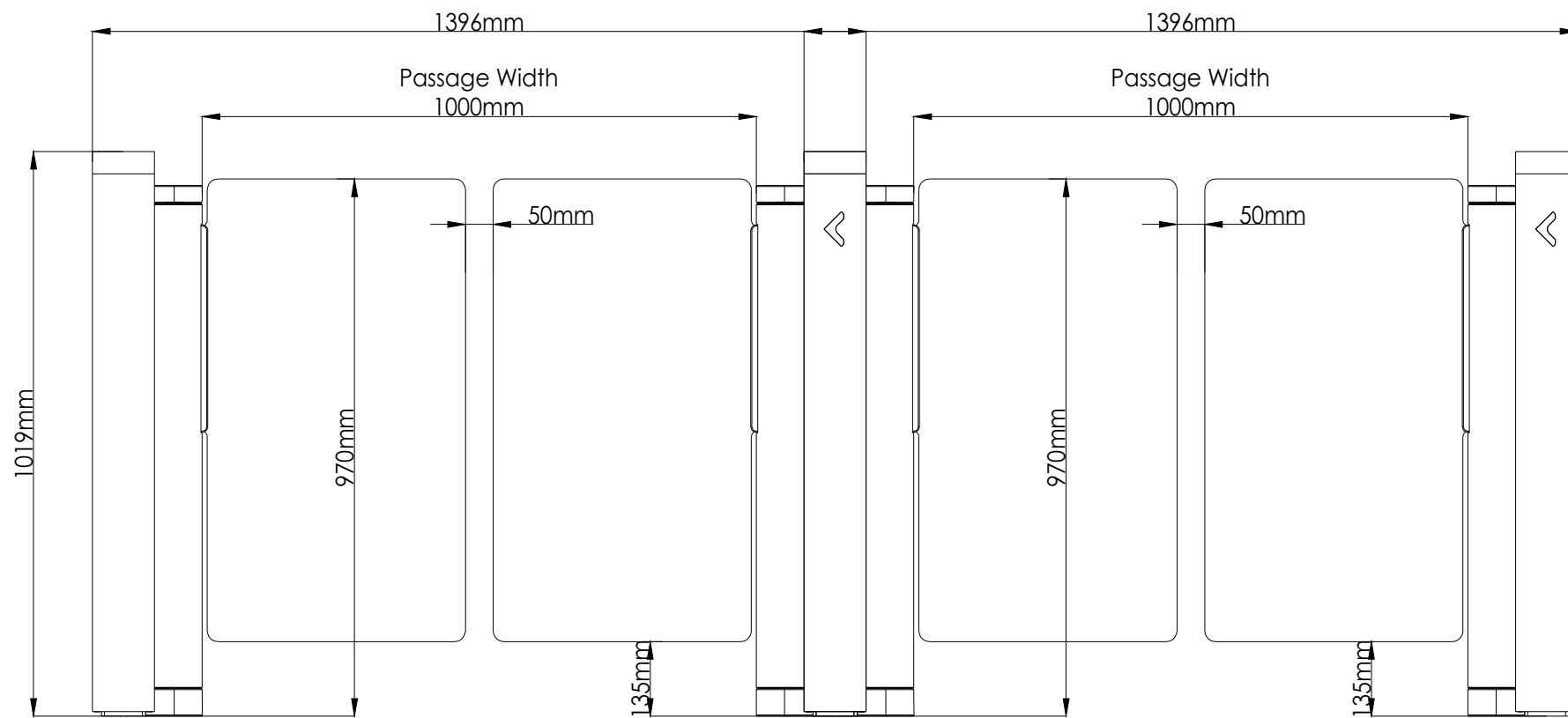

C

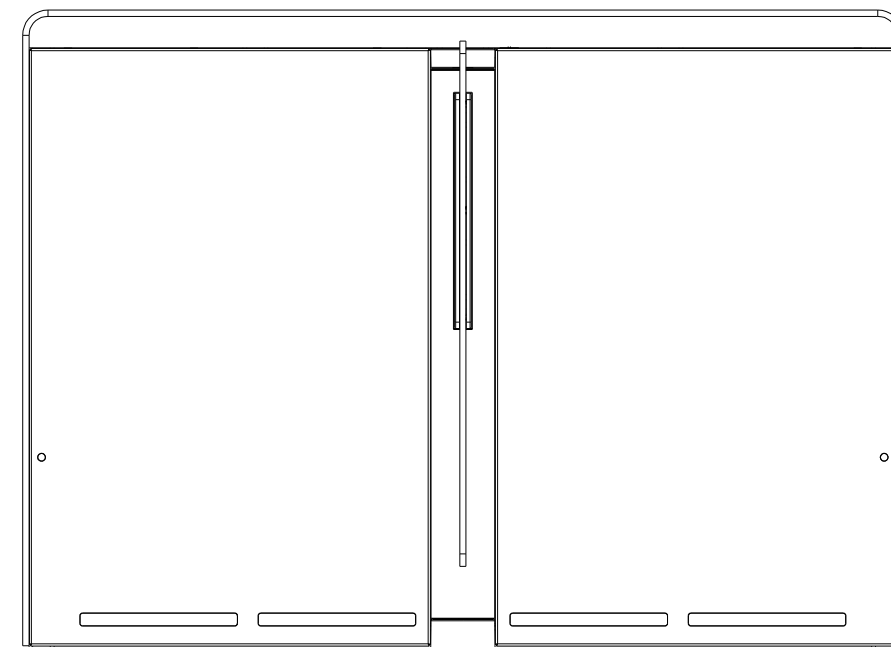

B

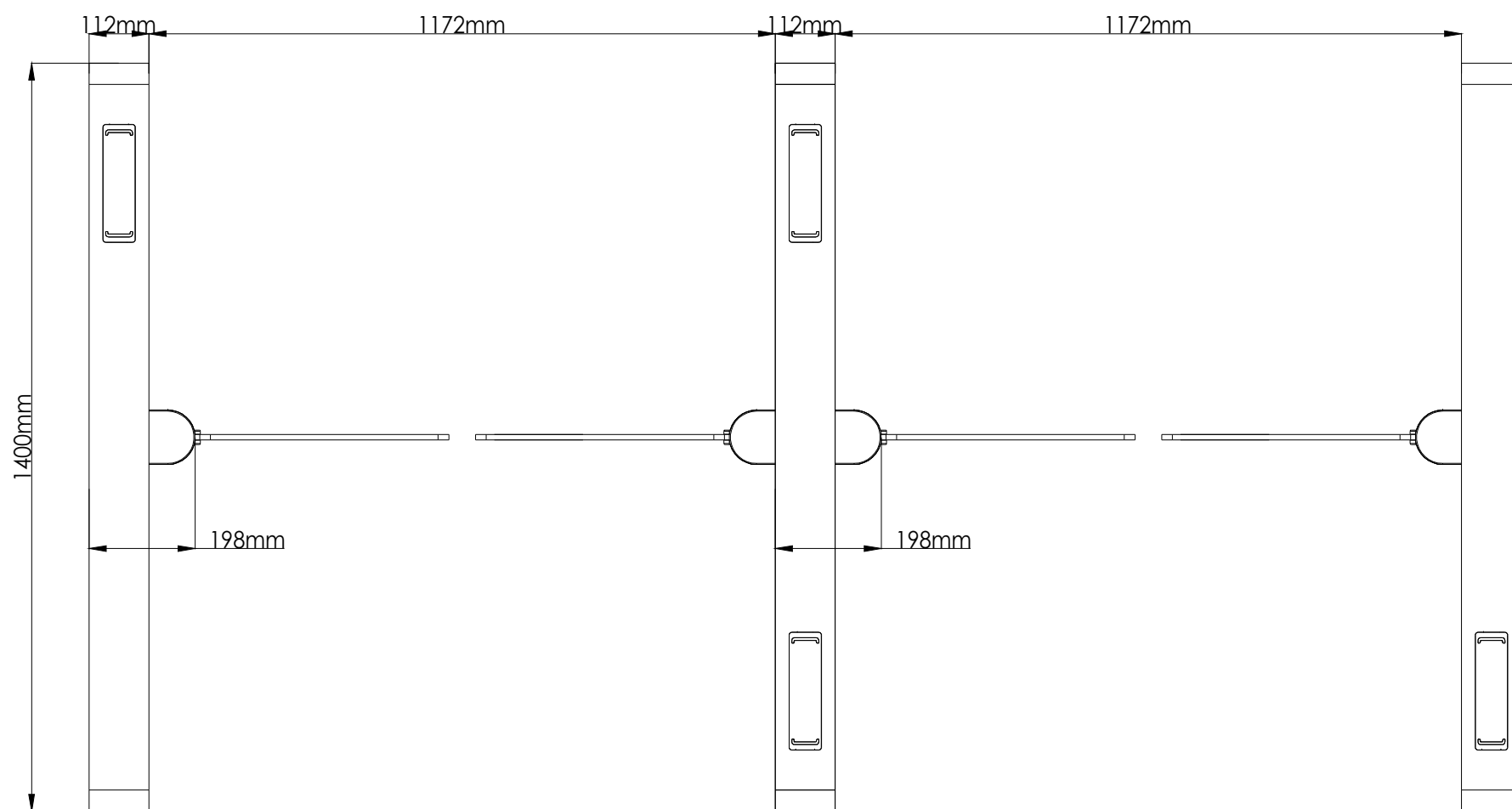

A

ASSA ABLOY			
DRAWING NAME: SG 400 BOXED 1400/ 1000-1000-970			
DRAWING NUMBER: CD-1167-02			
DRAWN F.C	DATE 4.06.2026	SIZE A4	REV Rev.002
SHEET: 1 OF 1			

4

3

2

1

D

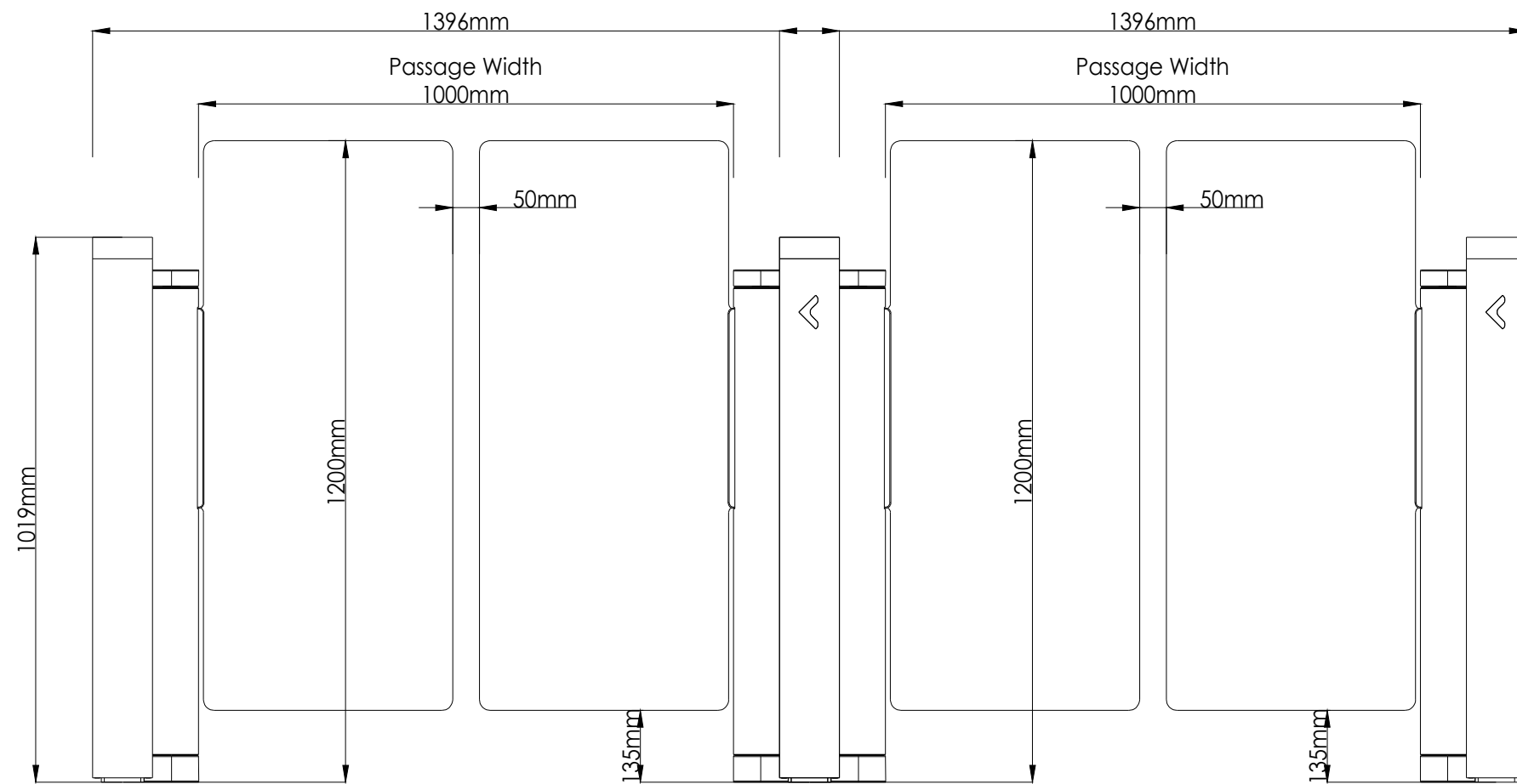

C

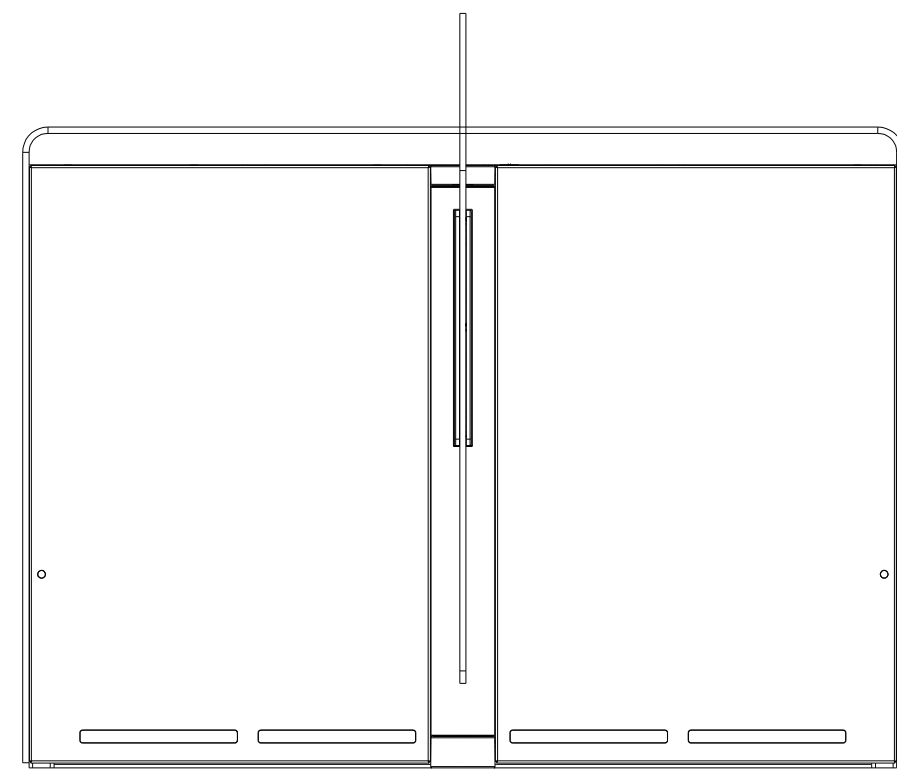

B

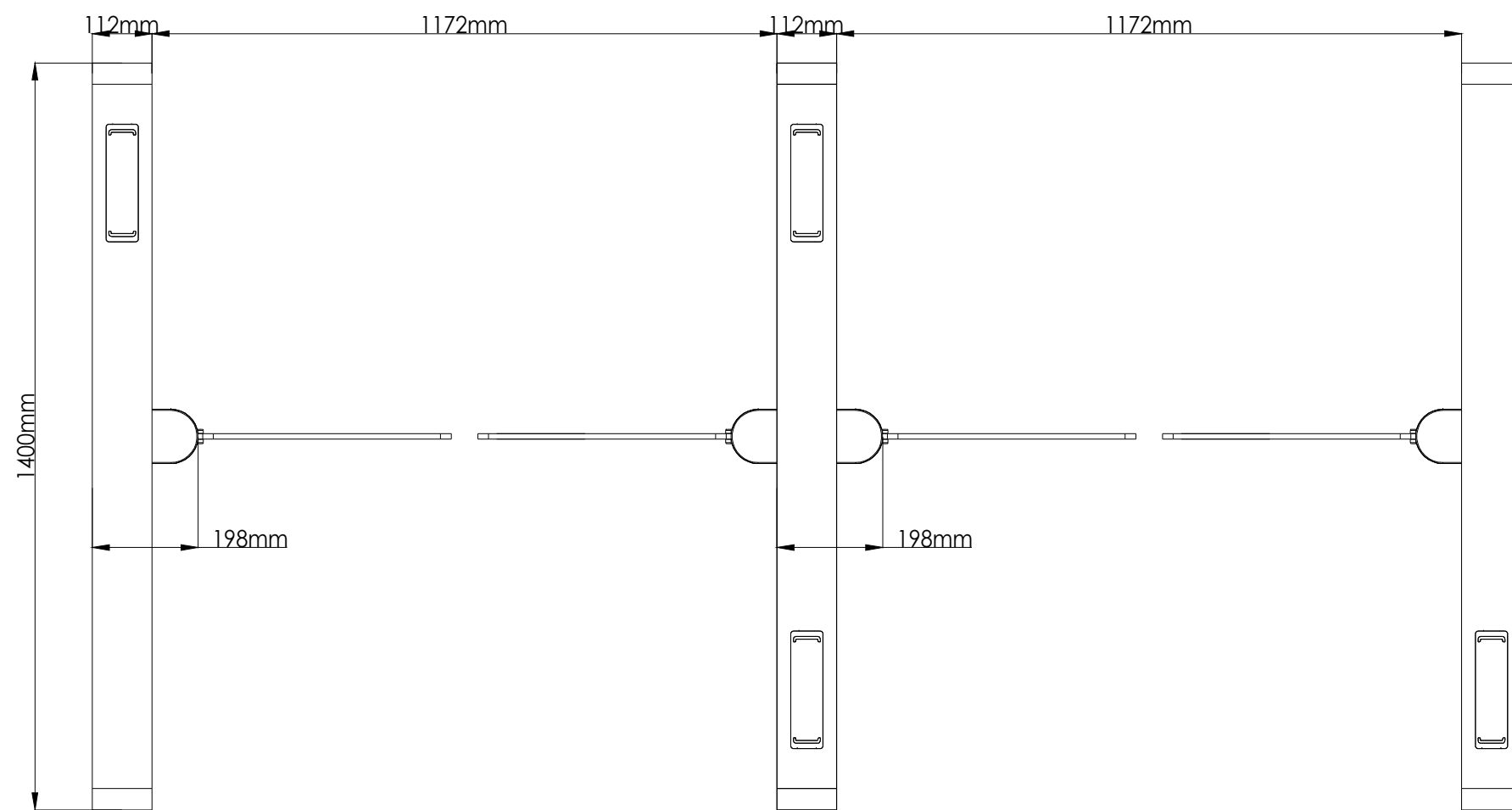

A

ASSA ABLOY			
DRAWING NAME: SG 400 BOXED 1400/ 1000-1000-1200			
DRAWING NUMBER: CD-1168-02			
DRAWN F.C	DATE 4.06.2026	SIZE A4	REV Rev.002
SHEET: 1 OF 1			

4

3

2

1

D

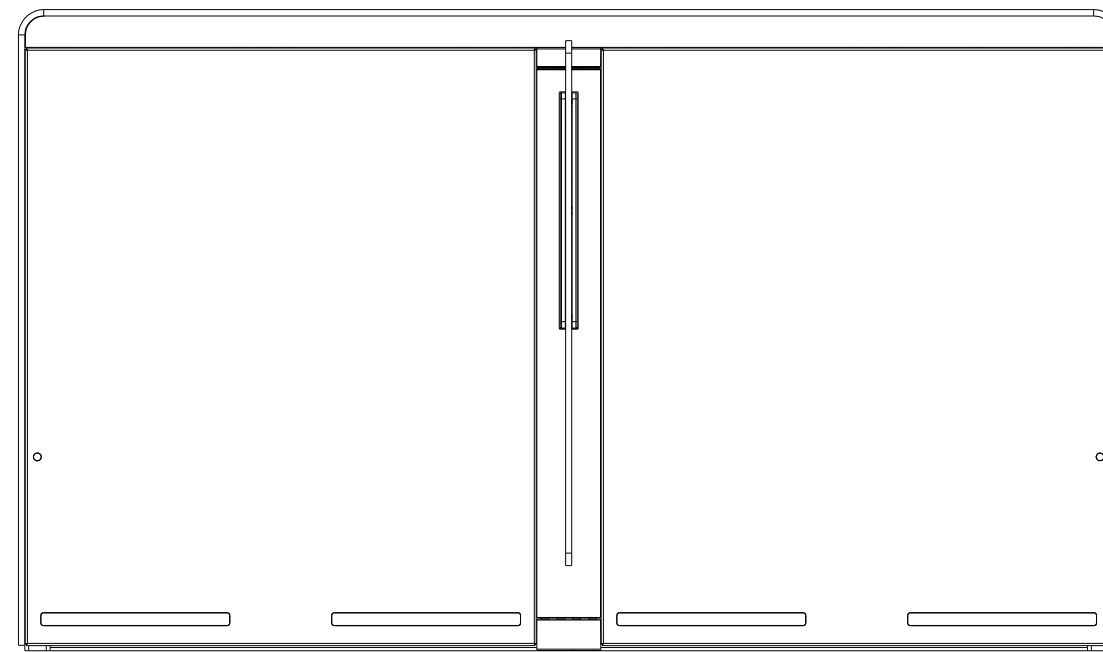
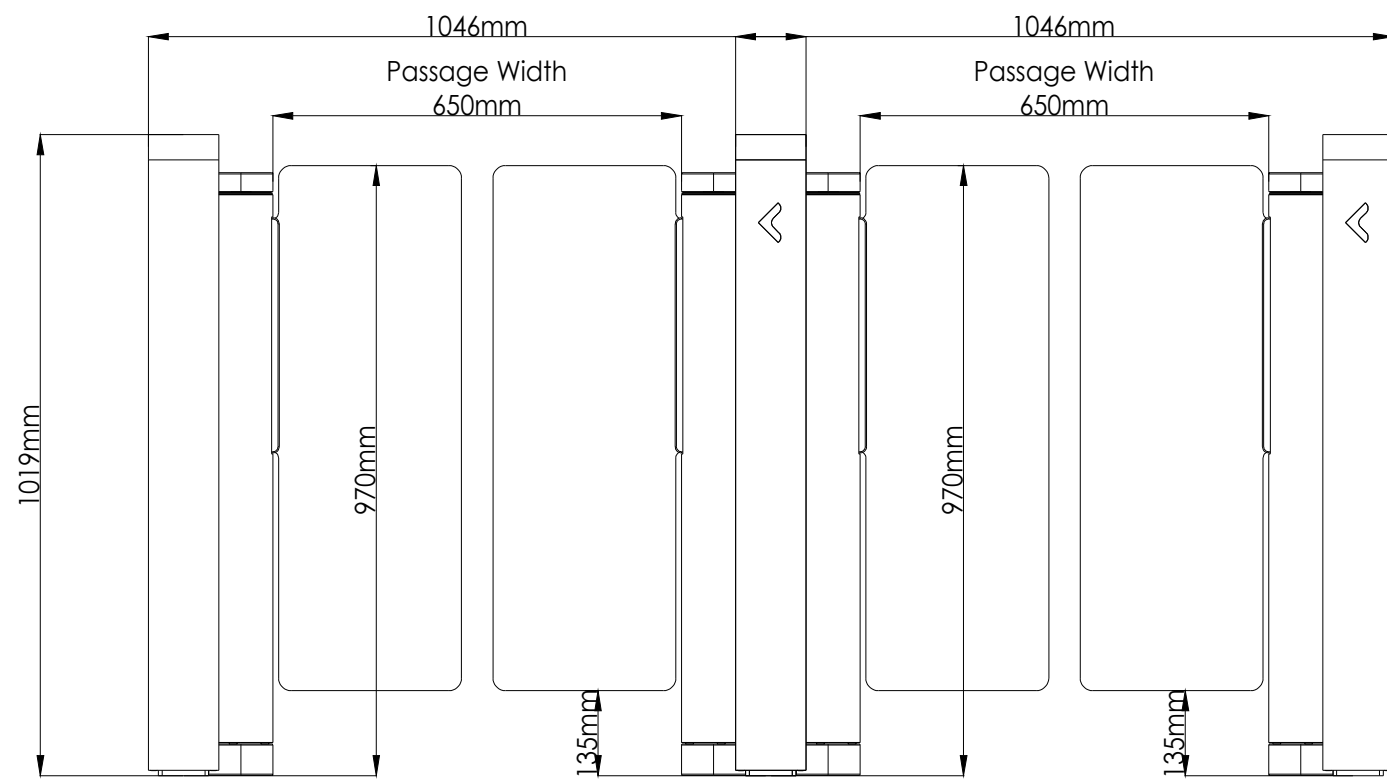

C

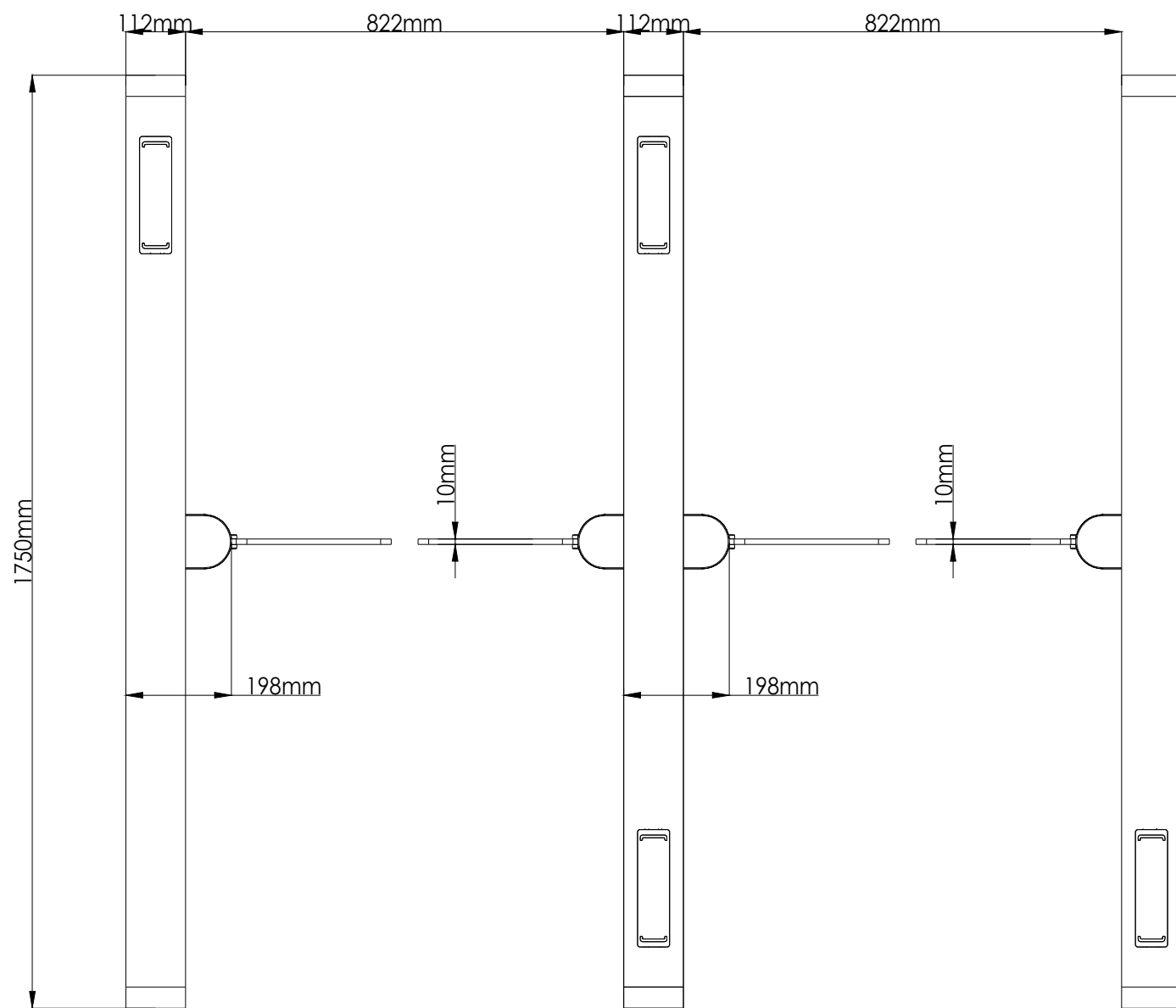

B

A

ASSA ABLOY			
DRAWING NAME: SG 400 BOXED 1750/ 650-650-970			
DRAWING NUMBER: CD-1170-02			
DRAWN F.C	DATE 4.06.2026	SIZE A4	REV Rev.002
SHEET: 1 OF 1			

4

3

2

1

D

C

B

A

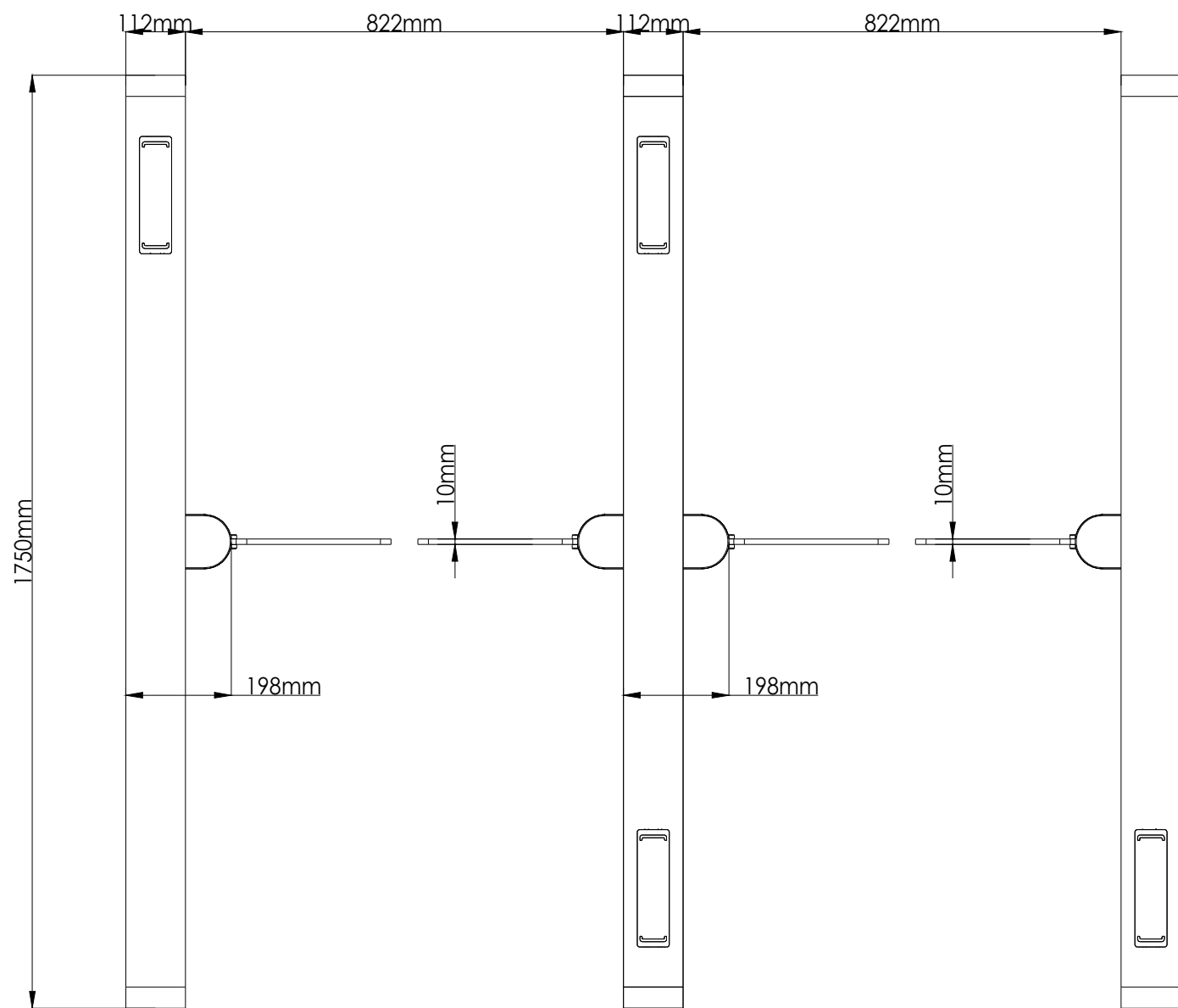
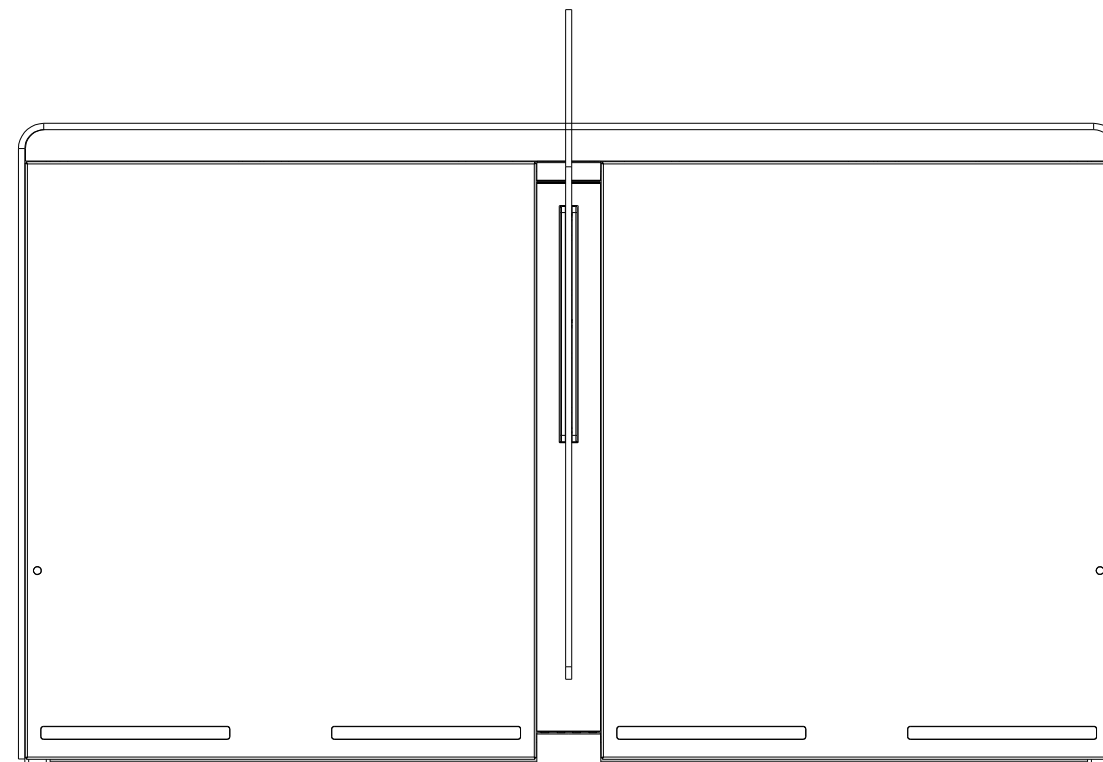
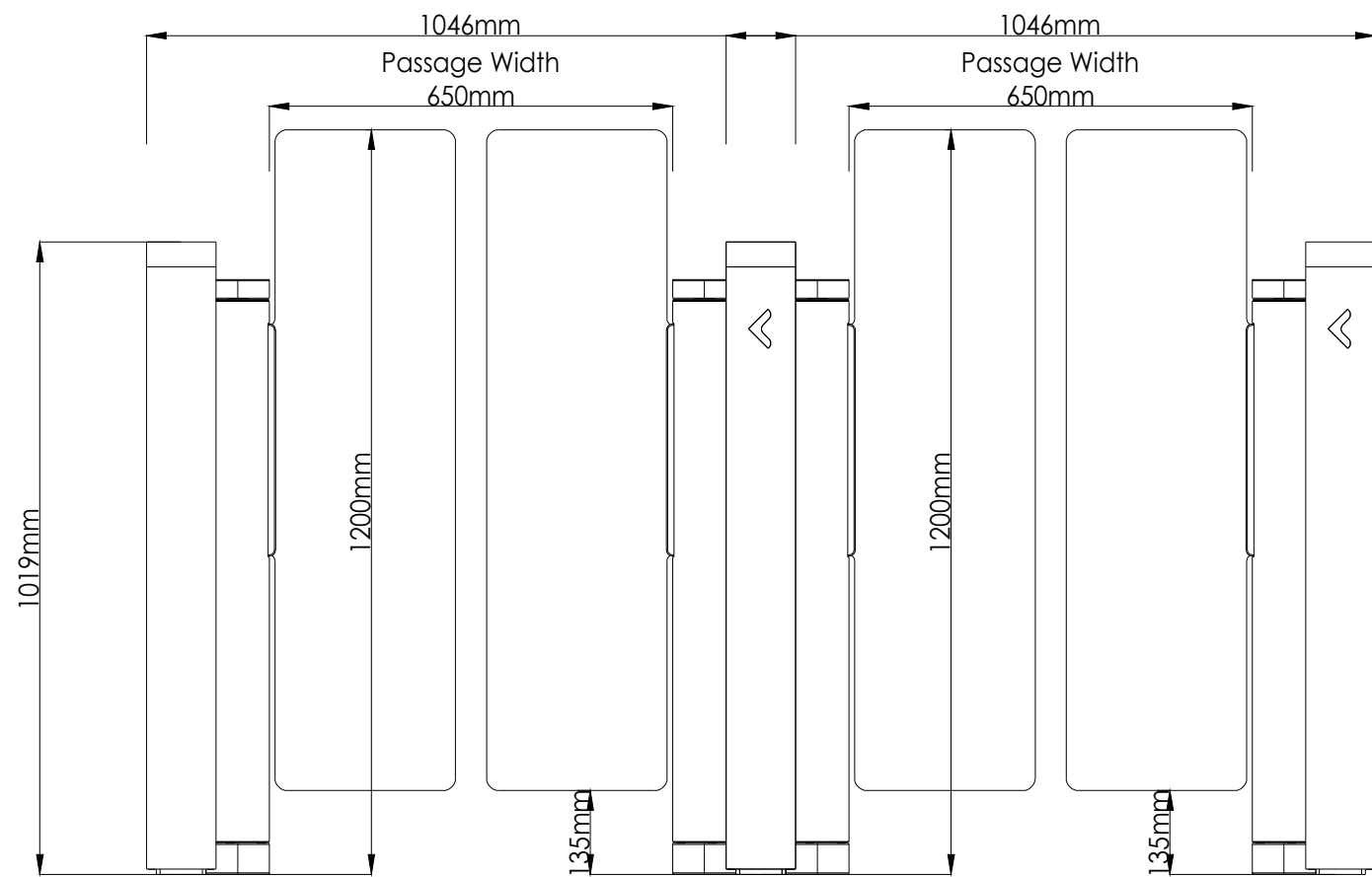

ASSA ABLOY			
DRAWING NAME: SG 400 BOXED 1750/ 650-650-1200			
DRAWING NUMBER: CD-1171-02			
DRAWN F.C	DATE 4.06.2026	SIZE A4	REV Rev.002
SHEET: 1 OF 1			

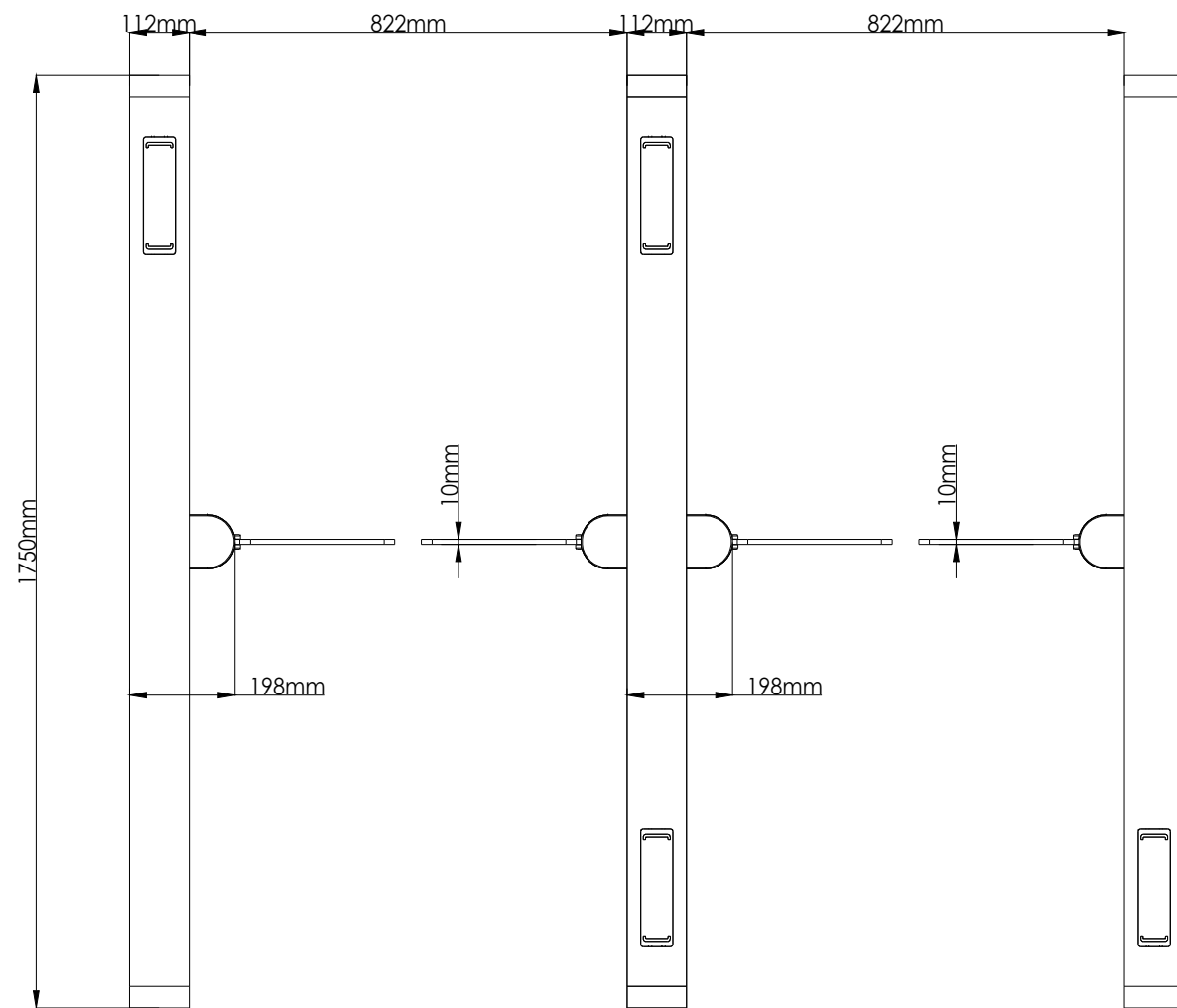
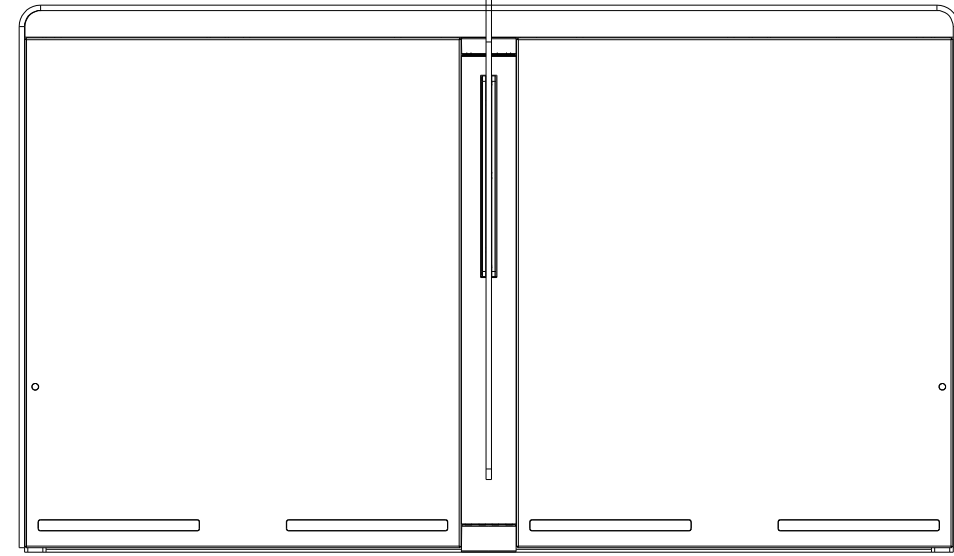
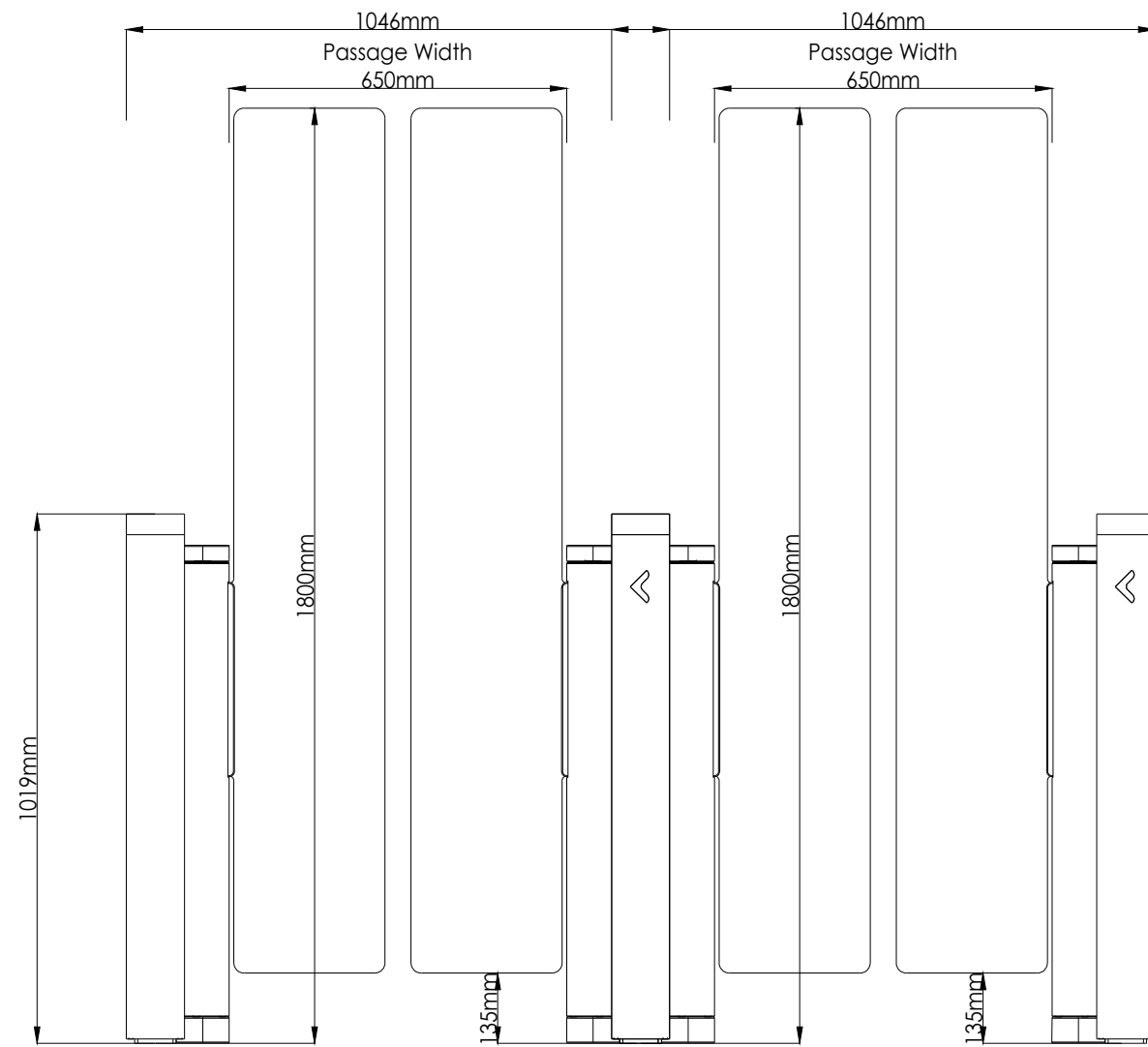

D

C

B

A

ASSA ABLOY

DRAWING NAME:
SG 400 BOXED 1750/ 650-650-1800

DRAWING NUMBER:
CD-1172-02

DRAWN	DATE	SIZE	REV
F.C	4.06.2026	A4	Rev.002

SHEET: 1 OF 1

4

3

2

1

D

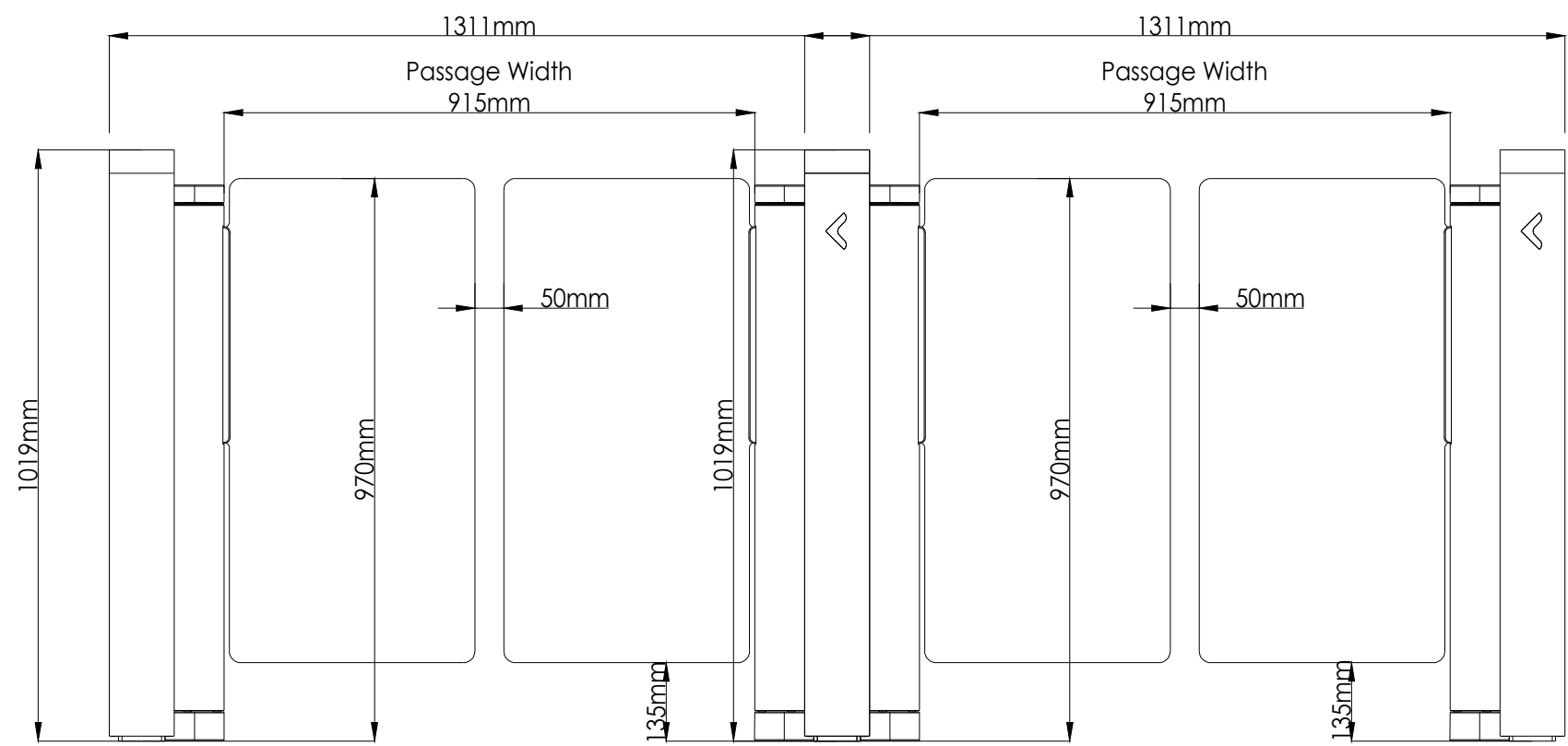

C

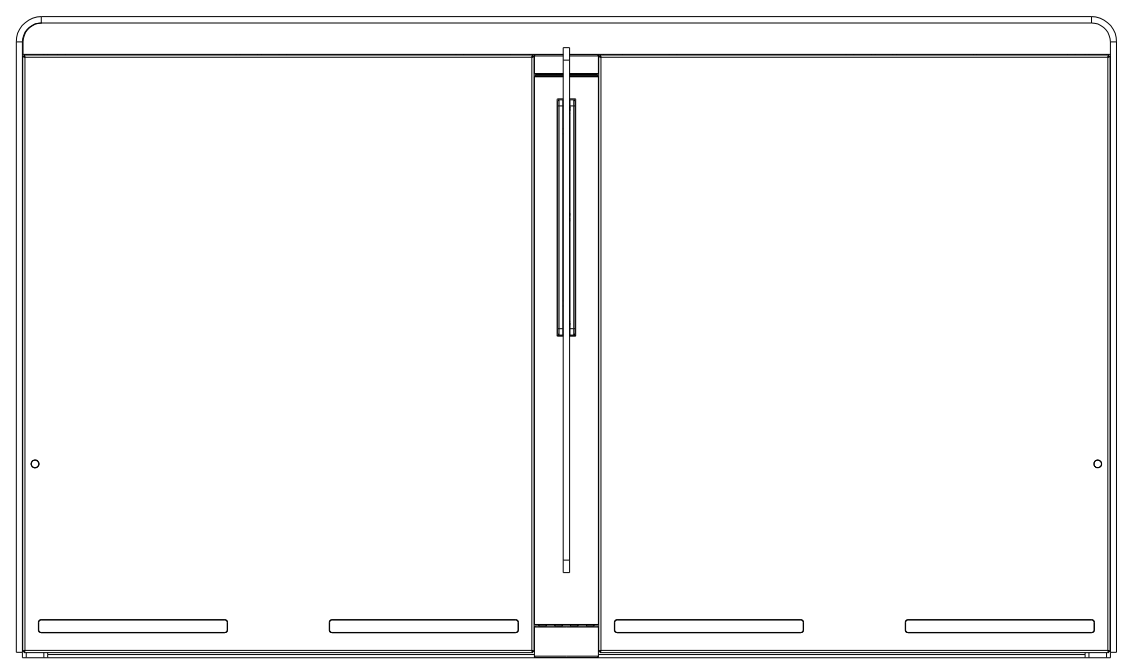

B

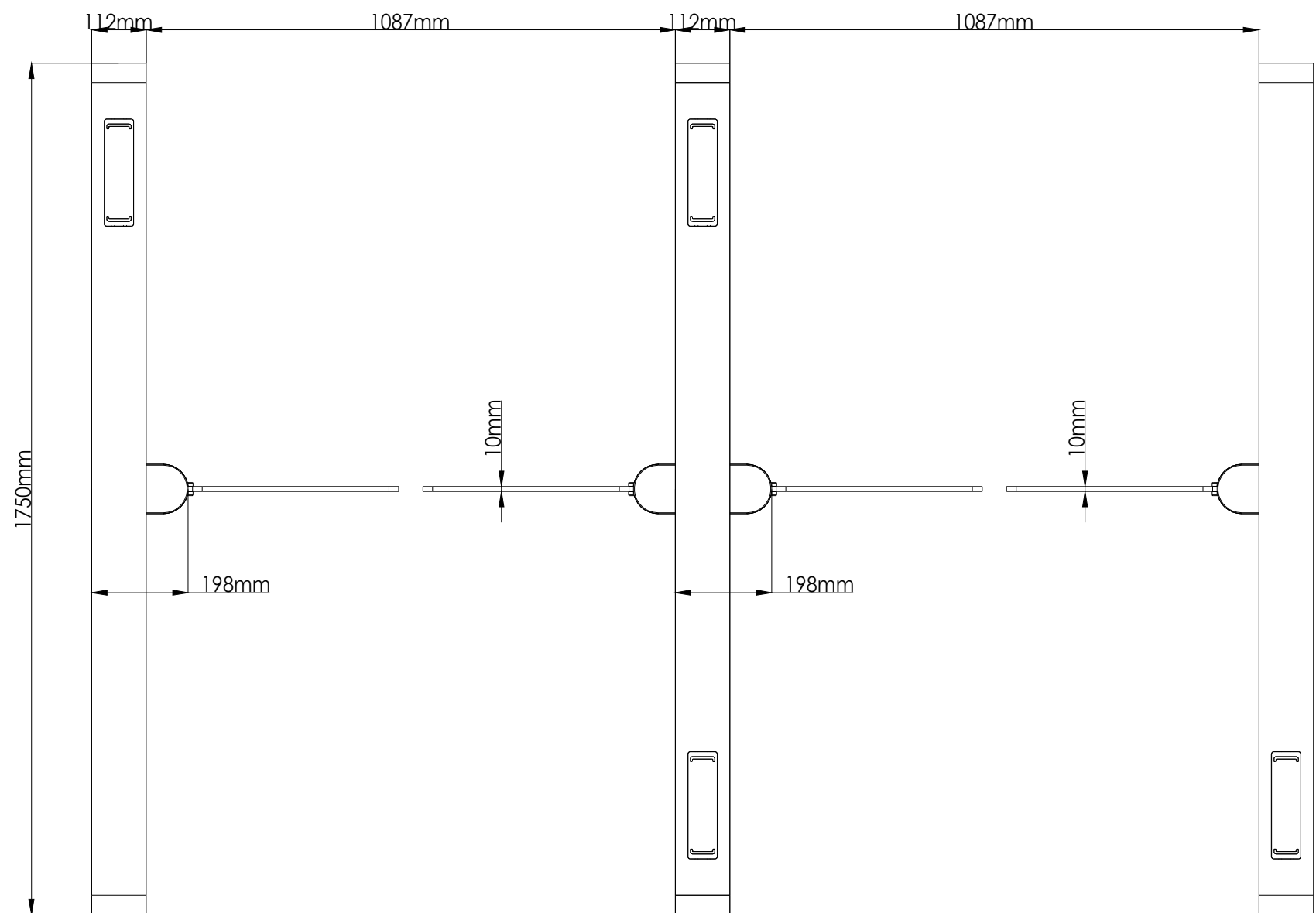

A

ASSA ABLOY			
DRAWING NAME: SG 400 BOXED 1750/ 915-915-970			
DRAWING NUMBER: CD-1173-02			
DRAWN F.C	DATE 4.06.2026	SIZE A4	REV Rev.002
SHEET: 1 OF 1			

4

3

2

1

D

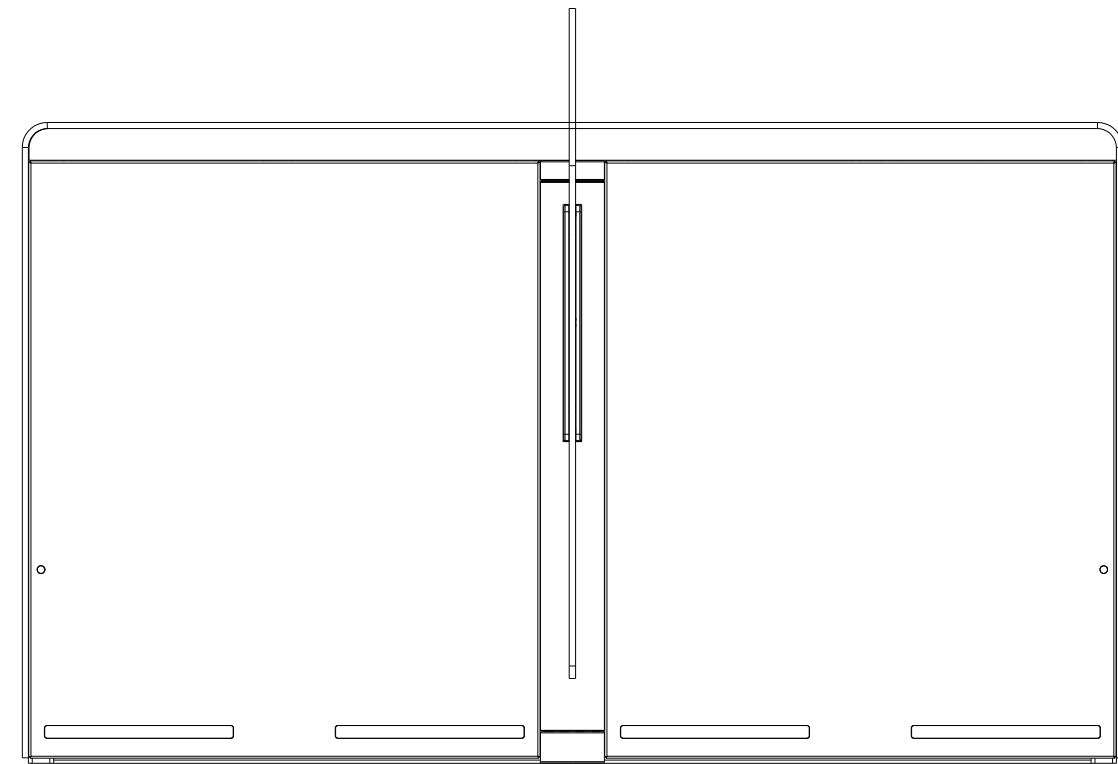
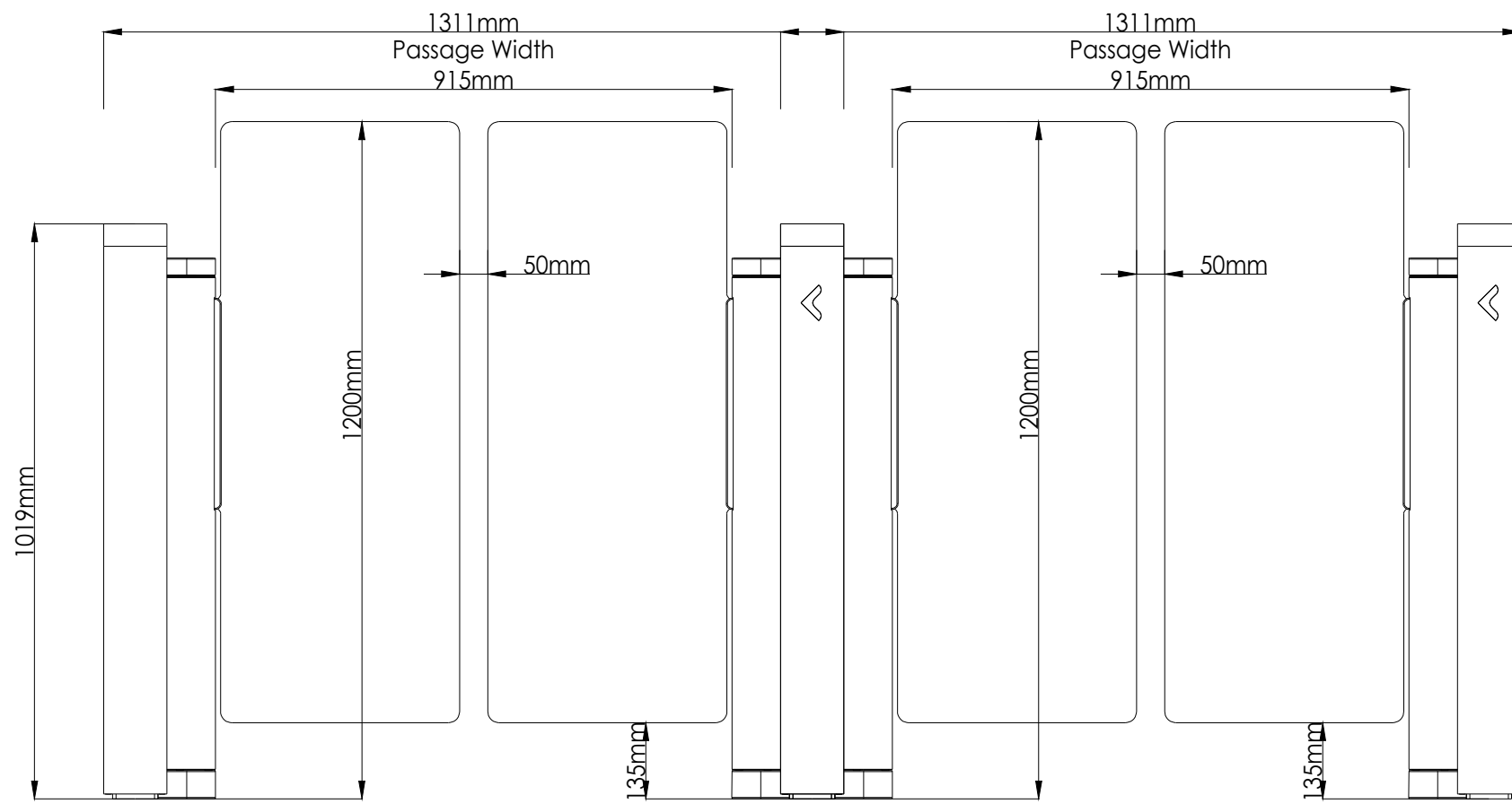

C

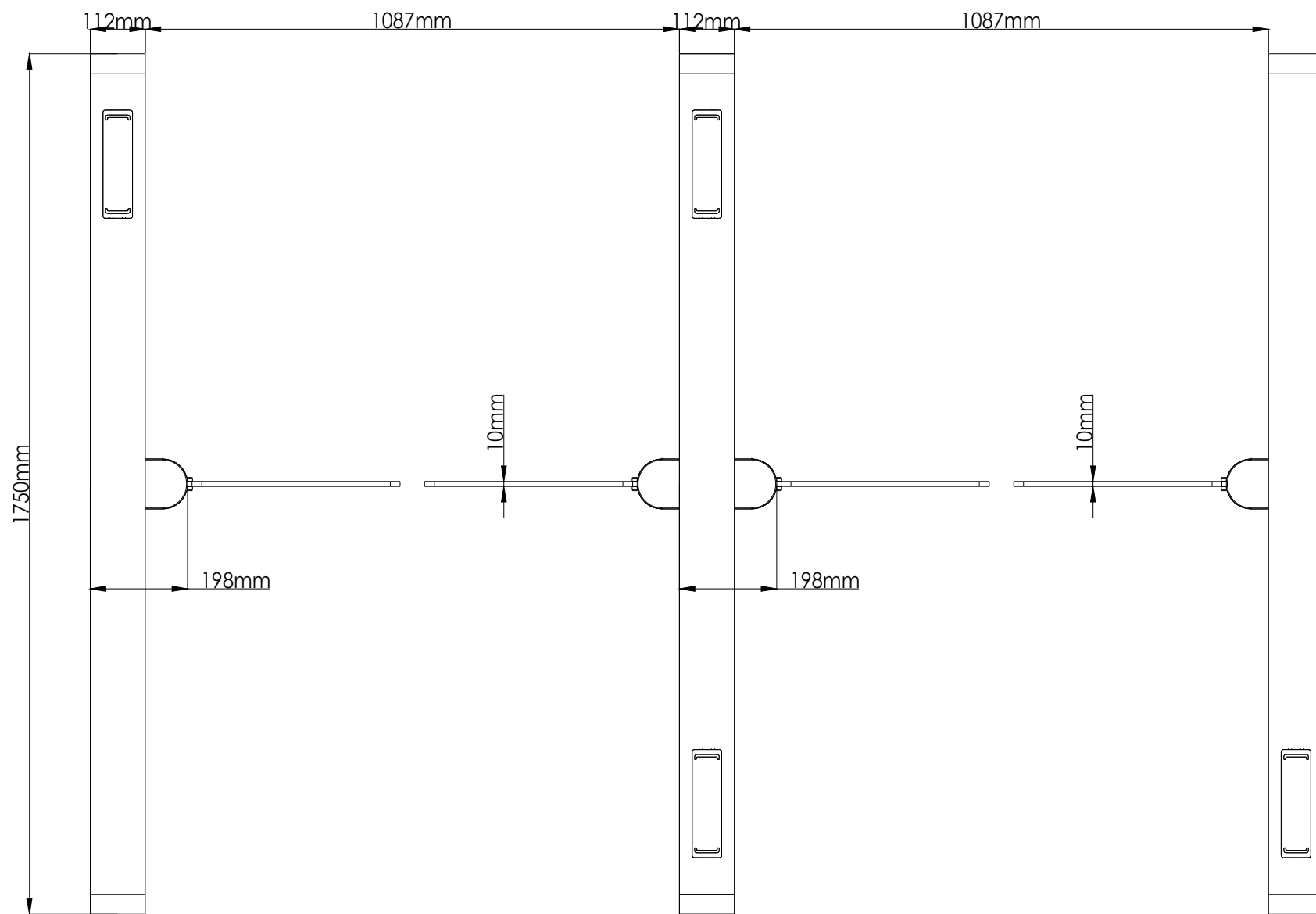

B

A

ASSA ABLOY			
DRAWING NAME: SG 400 BOXED 1750/ 915-915-1200			
DRAWING NUMBER: CD-1174-02			
DRAWN F.C	DATE 4.06.2026	SIZE A4	REV Rev.002
SHEET: 1 OF 1			

4

3

2

1

D

C

B

A

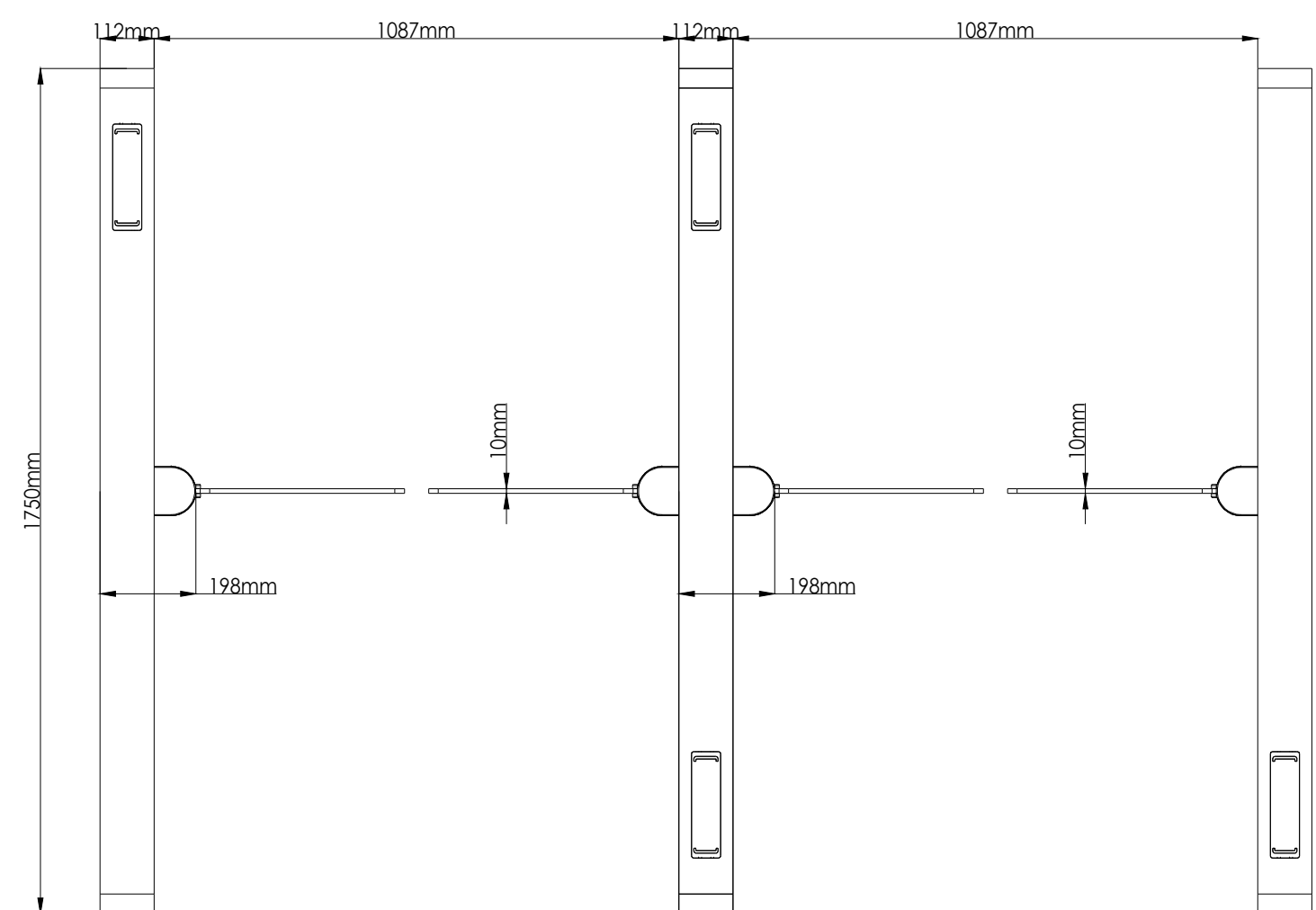
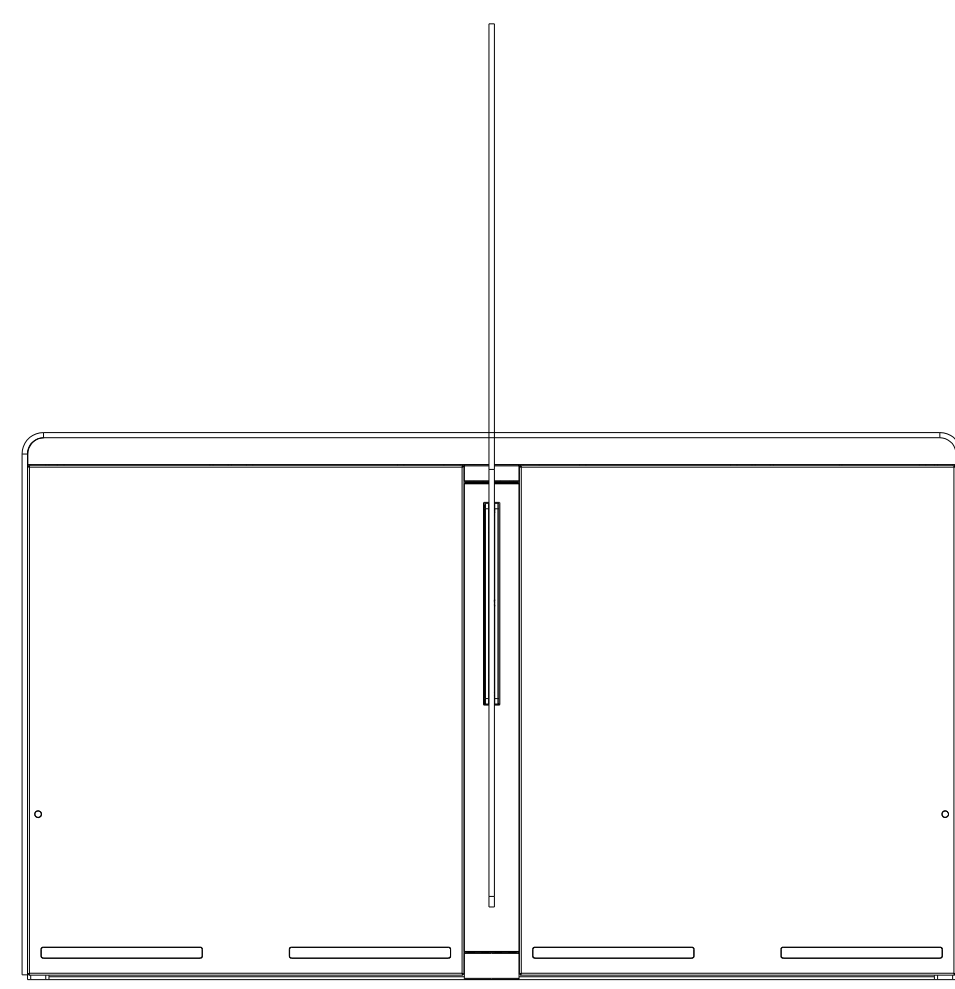
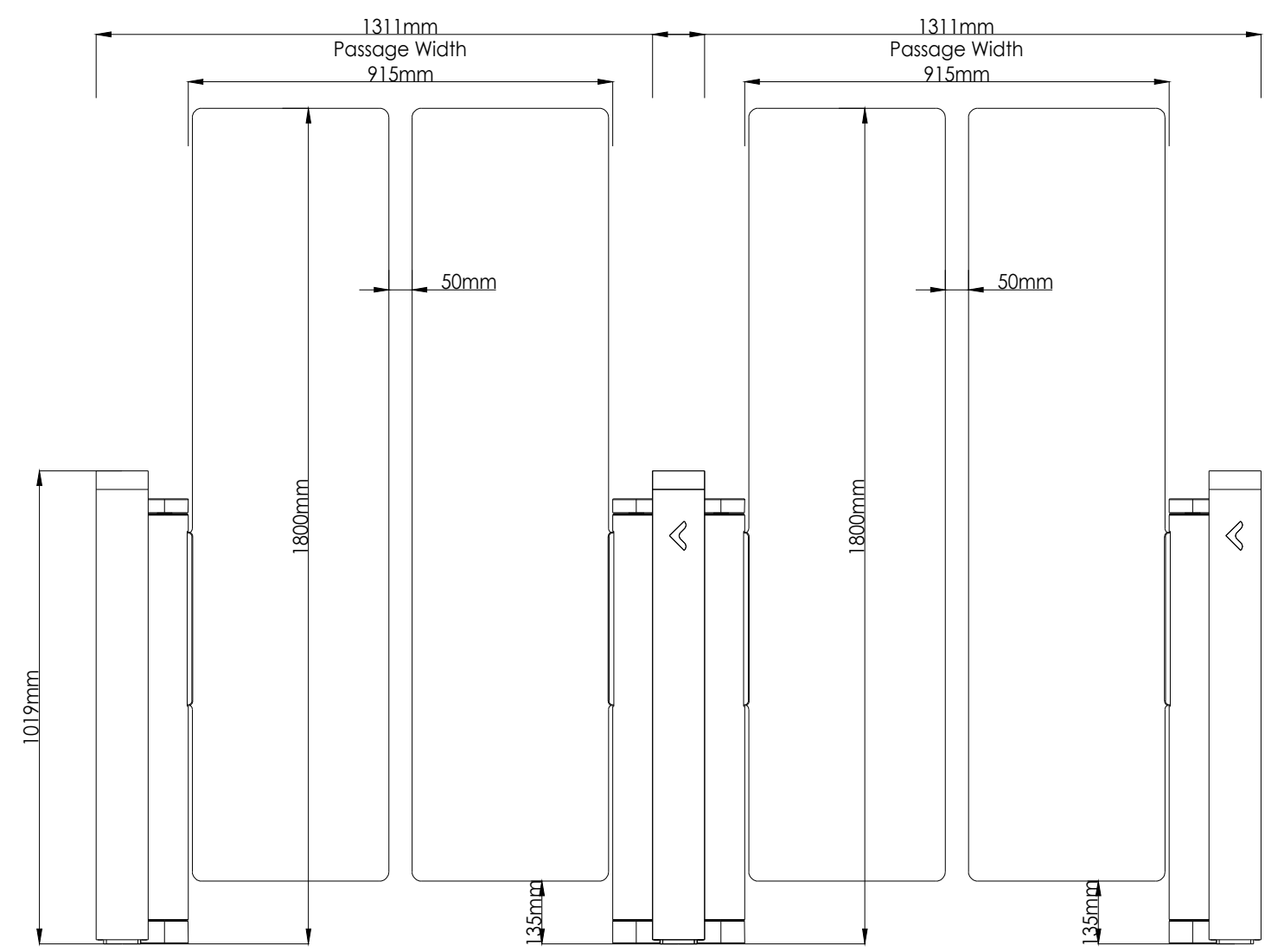

ASSA ABLOY			
DRAWING NAME: SG 400 BOXED 1750/ 915-915-1800			
DRAWING NUMBER: CD-1175-02			
DRAWN F.C	DATE 4.06.2026	SIZE A4	REV Rev.002
SHEET: 1 OF 1			

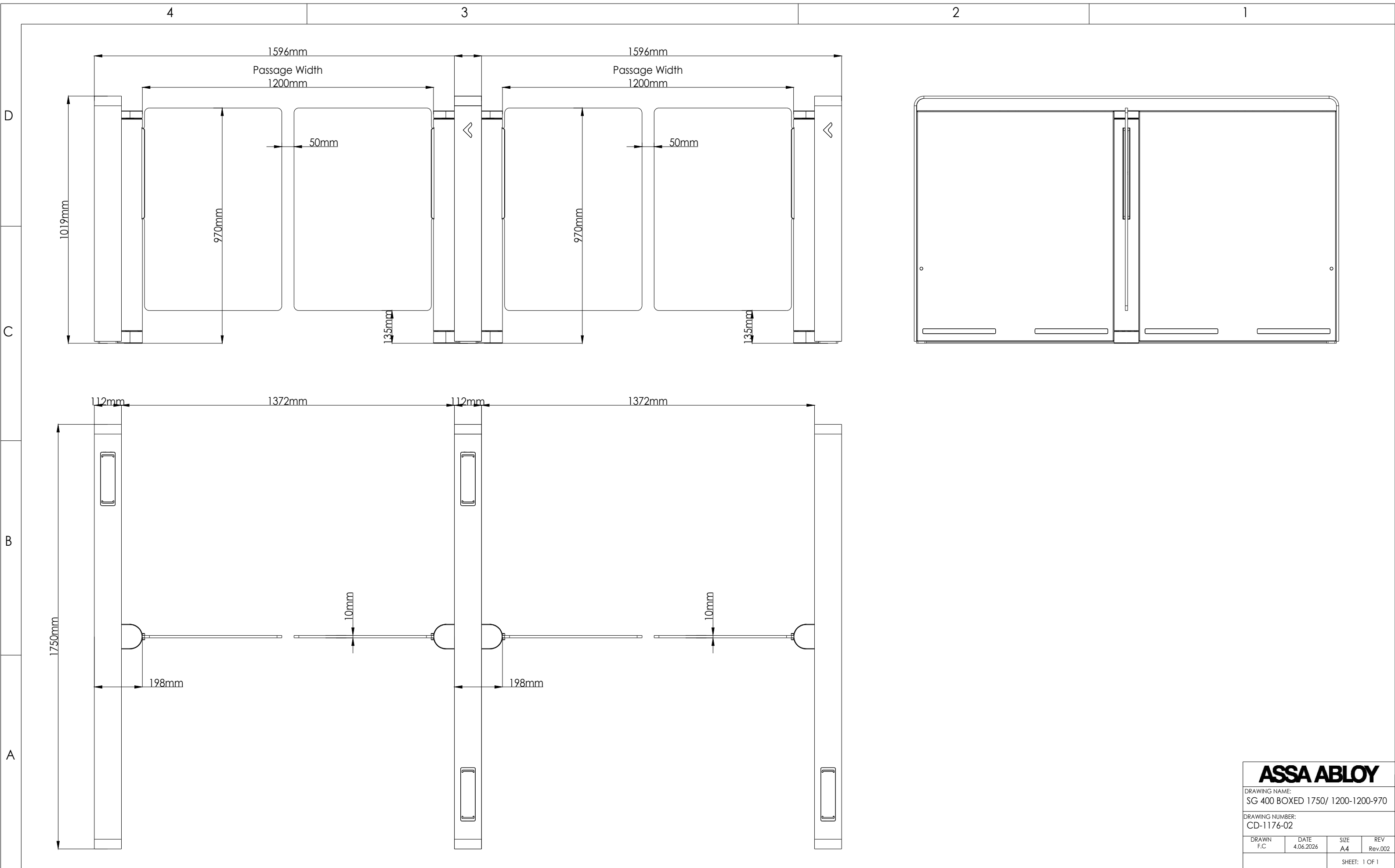

ASSA ABLOY			
DRAWING NAME: SG 400 BOXED 1750/ 1200-1200-970			
DRAWING NUMBER: CD-1176-02			
DRAWN F.C.	DATE 4.06.2026	SIZE A4	REV Rev.002
SHEET: 1 OF 1			

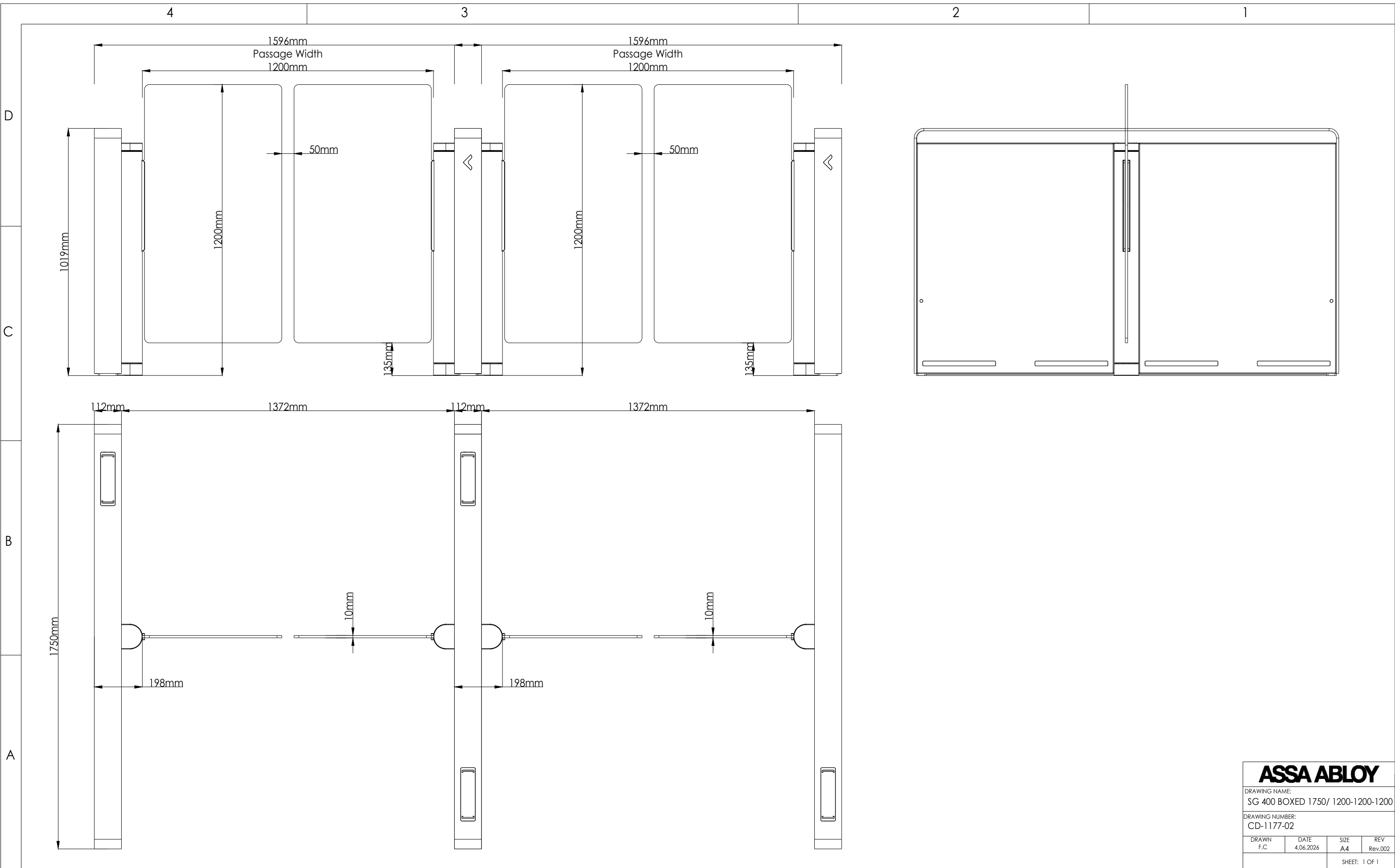

ASSA ABLOY			
DRAWING NAME: SG 400 BOXED 1750/ 1200-1200-1200			
DRAWING NUMBER: CD-1177-02			
DRAWN F.C.	DATE 4.06.2026	SIZE A4	REV Rev.002
SHEET: 1 OF 1			

4

3

2

1

D

C

B

A

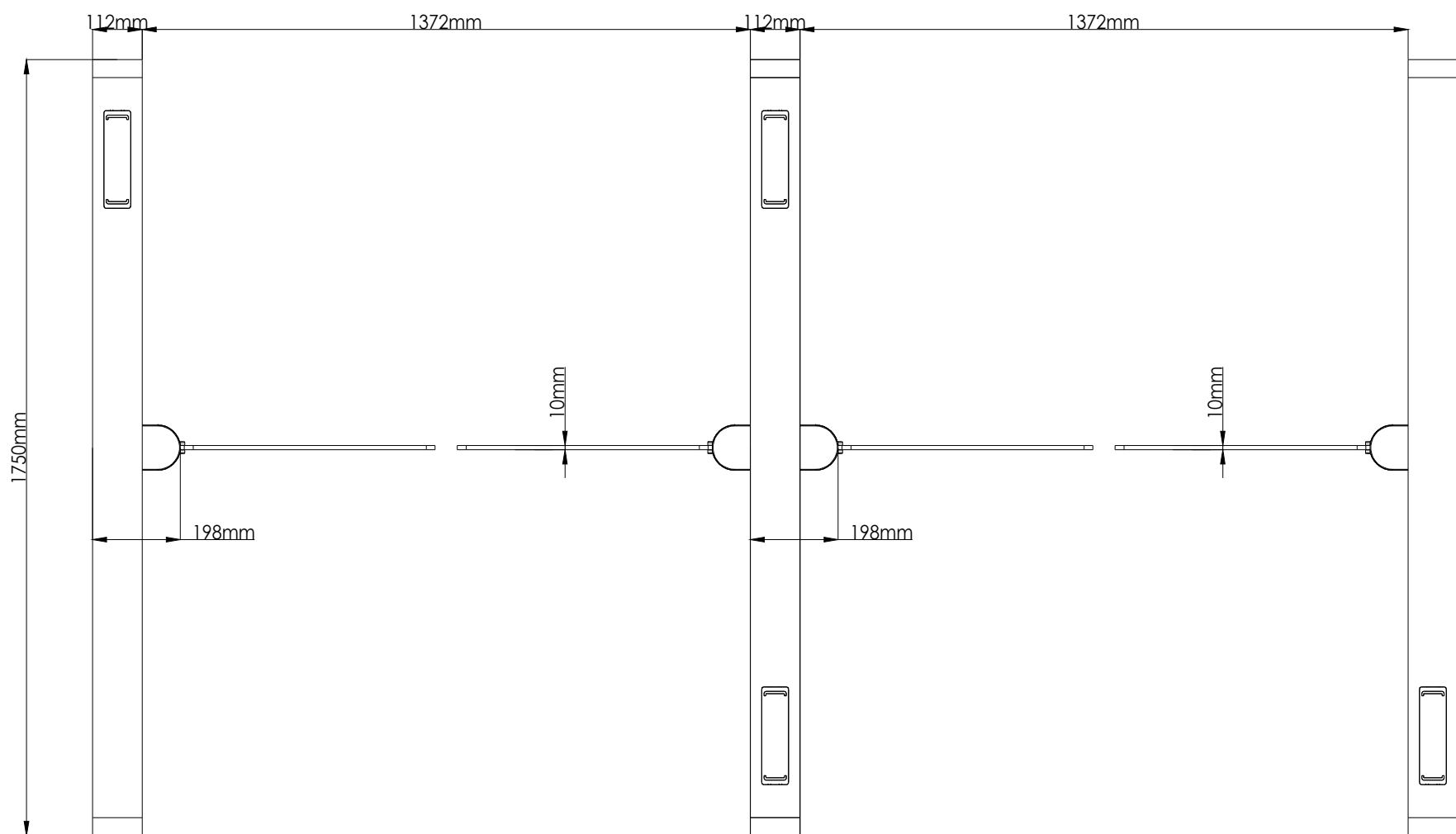
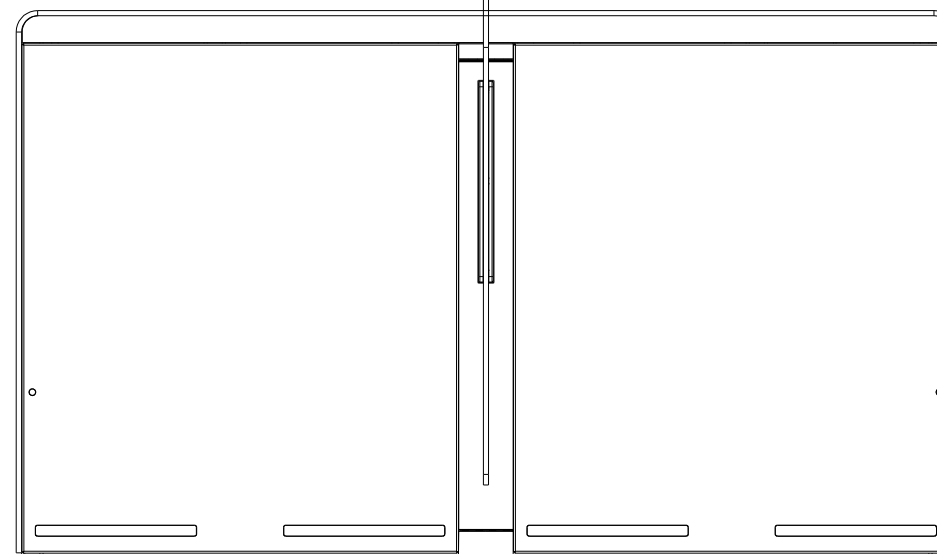
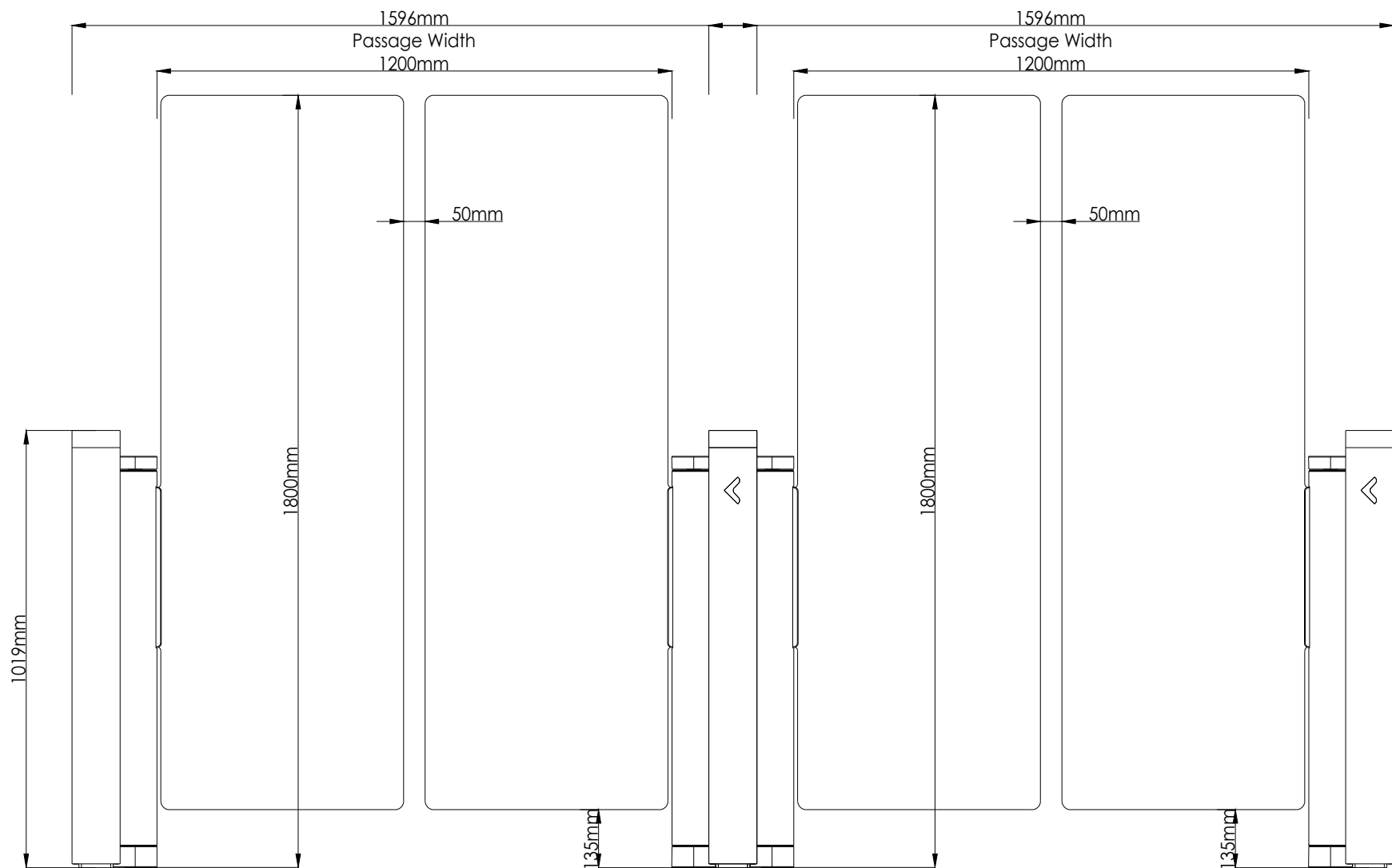

ASSA ABLOY			
DRAWING NAME: SG 400 BOXED 1750/ 1200-1200-1800			
DRAWING NUMBER: CD-1178-02			
DRAWN F.C	DATE 4.06.2026	SIZE A4	REV Rev.002
SHEET: 1 OF 1			