

4

3

2

1

D

C

B

A

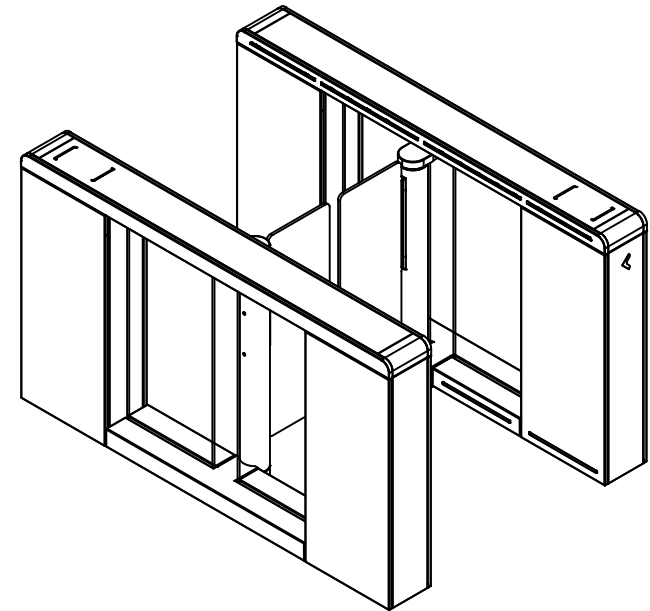
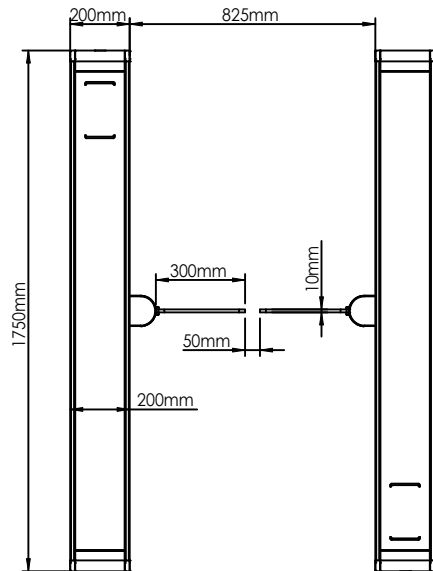
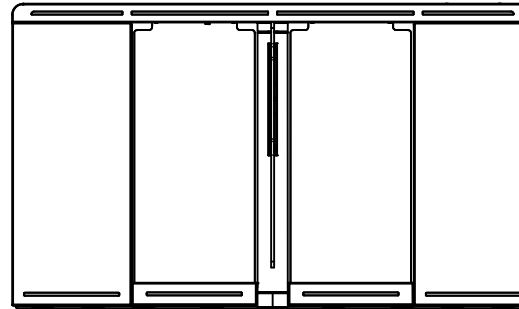
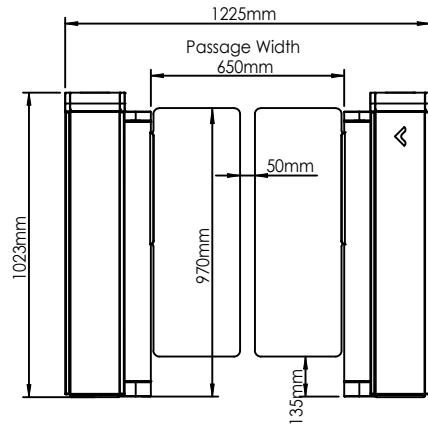

ASSA ABLOY			
DRAWING NAME: SG 200 Wide			
DRAWING NUMBER:			
DRAWN HJ.	DATE 19.02.2026	SIZE A4	REV Rev.002
			SHEET: 1 OF 1